

94-98

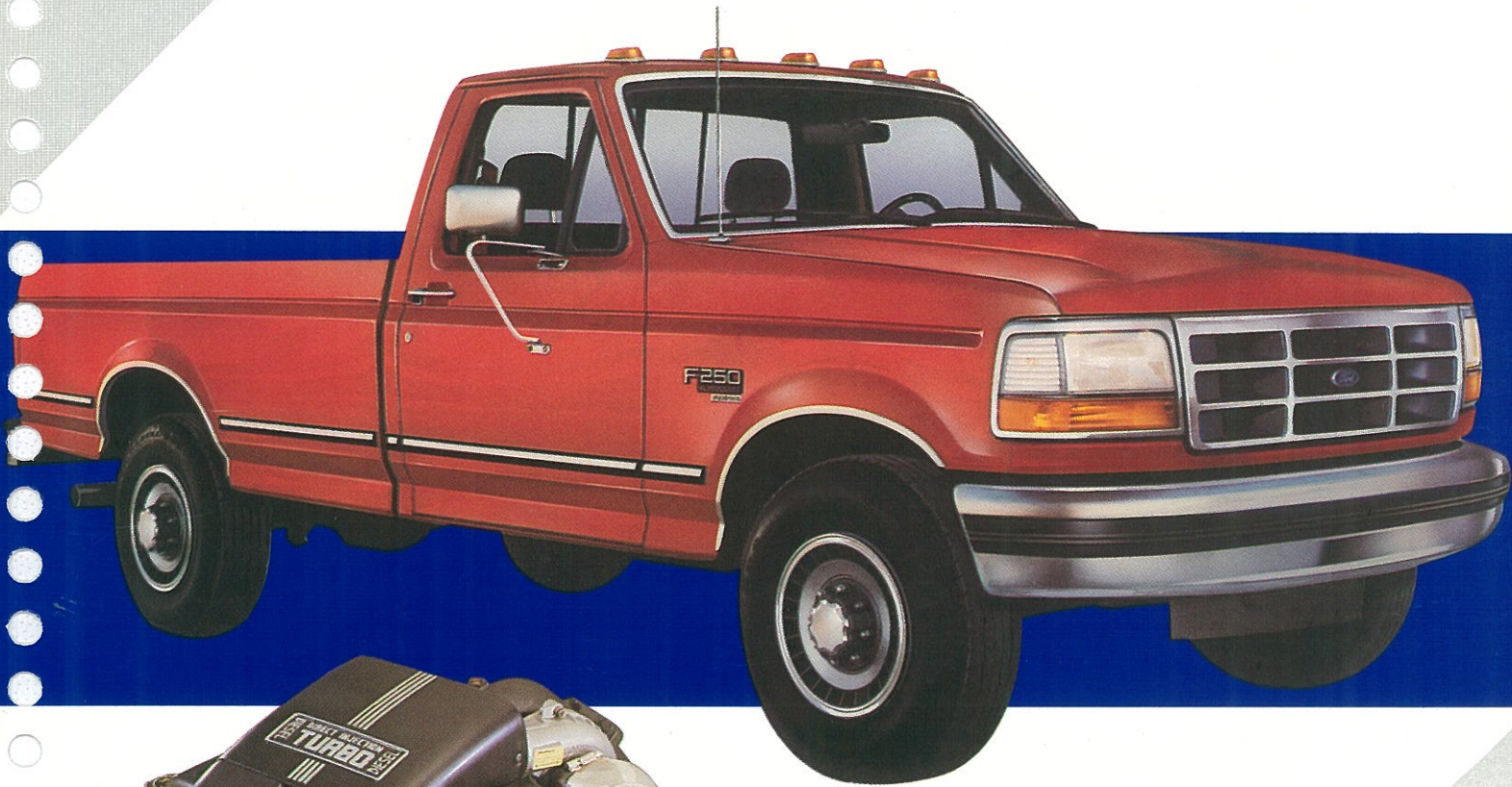

FEATURES DESCRIPTION SERVICE FEATURES



**7.3 DIT
DIRECT
INJECTION
TURBOCHARGED
DIESEL ENGINE**

FOREWORD

This publication is intended to provide technicians and service personnel with the latest technical advancements incorporated in the 7.3 DIT Diesel Engine. The information contained in this publication will supplement information contained in available service literature.

IMPORTANT SAFETY NOTICE

Appropriate service methods and proper repair procedures are essential for the safe, reliable operation of all motor vehicles, as well as, the personal safety of the individual doing the work. This manual provides general directions for accomplishing service and repair work with tested, effective techniques. Following them will help assure reliability.

There are numerous variations in procedures, techniques, tools, and parts for servicing vehicles, as well as, in the skill of the individual doing the work. This manual cannot possibly anticipate all such variations and provide advice or cautions as to each. Accordingly, anyone who departs from the instructions provided in this manual must first establish that he compromises neither his personal safety nor the vehicle integrity by his choice of methods, tools or parts.

The following list contains some general **WARNINGS** that you should follow when you work on a vehicle.

- Always wear safety glasses for eye protection.
- Use safety stands whenever a procedure requires you to be under the vehicle.
- Be sure that the ignition switch is always in the **OFF** position, unless otherwise required by the procedure.
- Never perform any service to the engine with the air cleaner removed and the engine running unless a turbocharger compressor inlet shield is installed.
- Set the parking brake when working on the vehicle. If you have an automatic transmission, set it in **PARK** unless instructed otherwise for a specific service operation. If you have a manual transmission, it should be in **REVERSE** (engine OFF) or **NEUTRAL** (engine ON) unless instructed otherwise for a specific service operation.
- Operate the engine only in a well-ventilated area to avoid the danger of carbon monoxide.
- Keep yourself and your clothing away from moving parts when the engine is running, especially the fan, belts, and the turbocharger compressor.
- To prevent serious burns, avoid contact with hot metal parts such as the radiator, turbocharger pipes, exhaust manifold, tail pipe, catalytic converter and muffler.
- Do not smoke while working on the vehicle.
- To avoid injury, always remove rings, watches, loose hanging jewelry, and loose clothing before beginning to work on a vehicle. Tie long hair securely behind the head.
- Keep hands and other objects clear of the radiator fan blades.

7.3 DIT DIESEL ENGINE TABLE OF CONTENTS

INTRODUCTION	5
7.3 DIT OVERVIEW.....	6
ENGINE FEATURES	
HORSEPOWER COMPARISON.....	7
TORQUE COMPARISON.....	7
SPECIFICATION CHART.....	8
PHYSICAL IDENTIFICATION.....	9
ENGINE SERIAL NUMBER.....	9
CALIBRATION LABEL.....	10
EMISSIONS LABEL.....	10
HEUI FUEL SYSTEM OPERATION	11
SYSTEM OVERVIEW.....	12
RATE & TIMING CONTROL.....	13
HIGHER INJECTION PRESSURE.....	13
FIVE MAJOR COMPONENTS	14
POWER TRAIN CONTROL MODULE (PCM).....	15
INJECTOR DRIVE MODULE (IDM).....	16
HIGH PRESSURE OIL SUPPLY PUMP.....	17
INJECTION PRESSURE REGULATOR (IPR).....	17
HEUI INJECTOR.....	18
STAGES OF INJECTION	21
HEUI ELECTRONIC CONTROL SYSTEM	24
IPR VALVE OPERATIONS	36
EXHAUST BACK-PRESSURE REGULATOR	36
7.3 DIT SYSTEMS	39
ENGINE FEATURES	49
UNIQUE SERVICE PROCEDURES	69
GLOSSARY	111-112
NOTES	113-114

INTRODUCING

7.3 DIT



1

7.3 DIT DIRECT INJECTION TURBOCHARGED DIESEL ENGINE

7.3 DIT DIESEL ENGINE

7.3 DIRECT INJECTION TURBOCHARGED DIESEL ENGINE OVERVIEW

7.3 DIT OVERVIEW

- This publication is not intended to replace the Service Manual but to introduce the 7.3 DIT.

- HORSEPOWER AND TORQUE COMPARISONS
- SYSTEM DESCRIPTIONS
- ENGINE FEATURES
- UNIQUE SERVICE PROCEDURES
- GLOSSARY

2

ENGINE FEATURES

- HEUI INJECTORS
- DIRECT INJECTION
- PCM CONTROLLED GLOW PLUGS
- EXHAUST BACK PRESSURE DEVICE
- REUSABLE VALVE COVER GASKETS
- GEROTOR OIL PUMP

ENGINE FEATURES

- The 7.3 DIT has been designed to meet customer expectations for increased performance.
- New features used in this engine are discussed in detail.

3

7.3 DIT DIESEL ENGINE

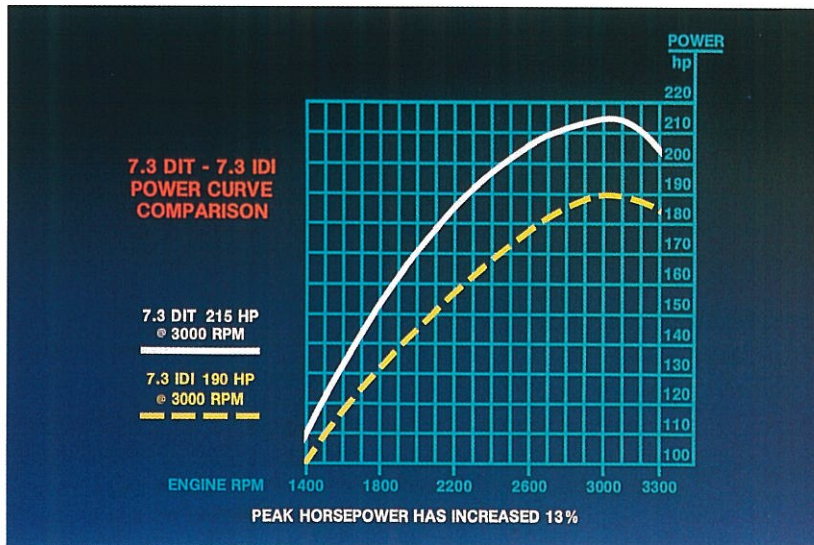

4

HORSEPOWER COMPARISON

- The 7.3 DIT engine will consistently produce 215 peak horsepower @ 3000 rpm at sea level and up to elevations of 10,000 feet.
- This is a 13% increase over the 7.3 IDI Turbocharged engine.
- Electronic engine management combined with turbocharging and more robust power cylinders provides an increase in horsepower over previous 7.3 engines, and accomplishes this at lower emission levels.

TORQUE COMPARISON

- The 7.3 Direct Injection Turbocharged Diesel engine produces 450 lb./ft. of torque between 1900 and 2100 rpm compared to the 7.3 IDI's 388 lb./ft. at 1400 rpm. This is a 16% increase over the 7.3 IDI Turbocharged engine.
- The 7.3 Direct Injection Turbocharged Diesel engine provides significantly increased performance, without sacrificing reliability of the drivetrain components.

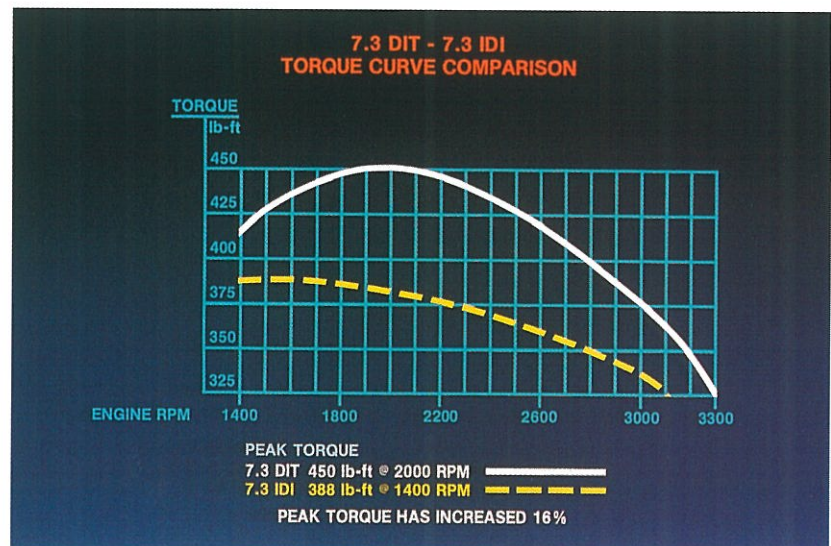

5

7.3 DIT DIESEL ENGINE

7.3 DIT DIESEL ENGINE SPECIFICATIONS

ENGINE TYPE	DIESEL, 4-CYCLE
CONFIGURATION	OHV-V8
DISPLACEMENT	444 cu. in. (7.3L)
BORE AND STROKE	4.11 x 4.18 (10.44 x 10.62cm)
COMPRESSION RATIO	17.5:1
ASPIRATION	TURBOCHARGED
RATED POWER @RPM	215 @ 3000 RPM
PEAK TORQUE @ RPM	450 @ 1900 RPM
ENGINE ROTATION, FACING FLYWHEEL	COUNTER CLOCKWISE
COMBUSTION SYSTEM	DIRECT INJECTION
TOTAL ENGINE WEIGHT (DRY)	920 LB. (417.6 Kg)
COOLANT FLOW	80 GPM (302.8L/min) @ 3300 RPM
FAN-TO-CRANK RATION	1.1:1
HEAT REJECTION	30 BTU/Hp-Min
AIR FLOW @ RPM	548 CFM (15.5 m ³ /min.) @ 2600 RPM
EXHAUST FLOW @ RPM	1600 CFM (45.3 m ³ /min.) @ 3000 RPM
COOLING-SYSTEM CAPACITY (ENGINE ONLY)	12 QUARTS (11.4 LITERS)
LUBE-SYSTEM CAPACITY (INCLUDING FILTER)	12 QUARTS (11.4 LITERS)

6

SPECIFICATIONS

- The 7.3 DIT Diesel engine is a totally new engine design that will provide improved fuel economy, durability, and performance.

7.3 DIT DIESEL ENGINE PHYSICAL IDENTIFICATION

7.3 DIT PHYSICAL IDENTIFICATION

- ENGINE SERIAL NUMBER
- CALIBRATION LABEL
- ENGINE FEATURES

PHYSICAL IDENTIFICATION

- Three ways to identify are:
- ENGINE SERIAL NUMBER
- CALIBRATION LABEL
- ENGINE FEATURES

7

ENGINE SERIAL NUMBER

- The engine serial number is located on rear oil cooler pad.
- 7.4 - is the engine family identifier
- JU2U is a manufacturing designator
- 000501* is a sequential build number

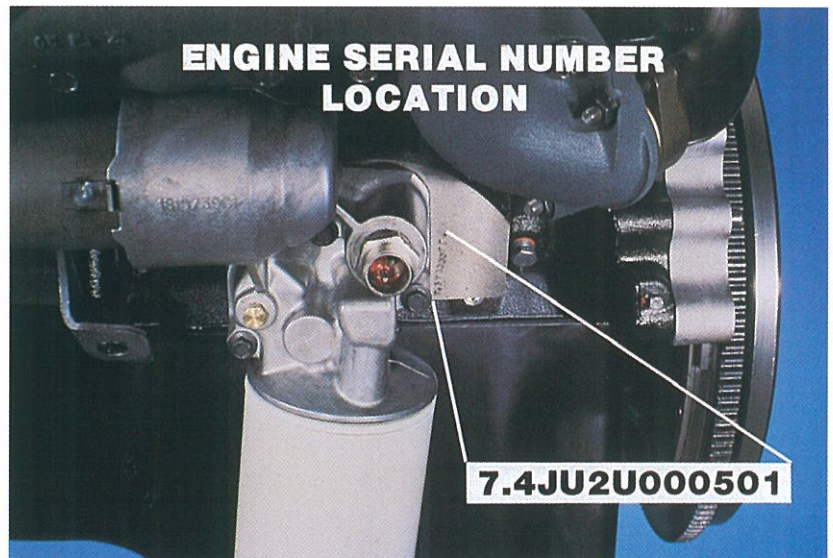

8

9

7.3 DIT DIESEL ENGINE PHYSICAL IDENTIFICATION

CALIBRATION LABEL

- The calibration label is located on the front of the high pressure oil reservoir.
- The manufacturing date is identified.

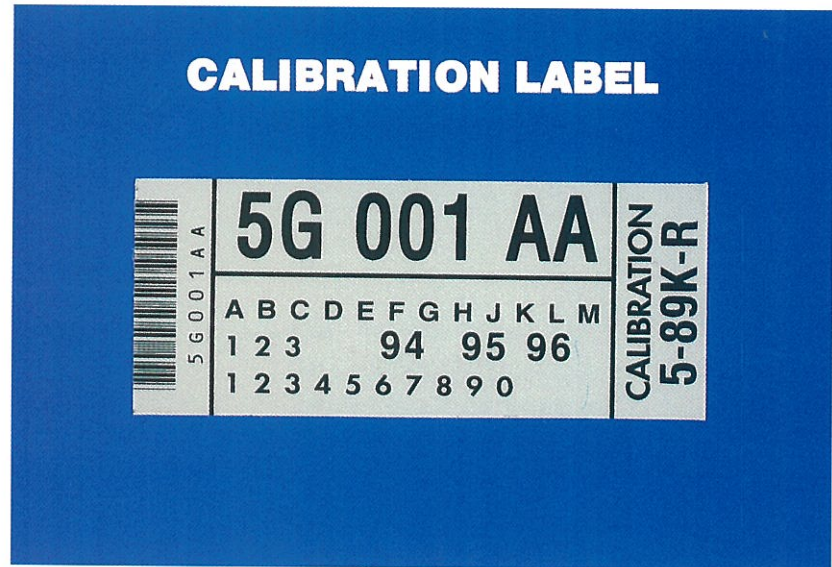

9

EMISSION LABEL

	MODEL/MODÈLE	A215
7.3 DIT ENGINE FAMILY	ADV. BHP @ RPM (PUISS. NOM. À TR/MIN)	215 @ 3000
FAMILLE DE MOTEUR 7.3 DIT	FUEL RATE @ ADV. BHP, MM ³ /STROKE. (DÉBIT DE CARB. À PUISS. NOM. MM ³ /COURSE)	73.8
EMISSION CONTROL INFORMATION	INJECTION TIMING: NON-ADJUSTABLE CALAGE D'INJECTION: NON-RÉGLABLE	
RENSEIGNEMENTS DE DÉPOLLUTION	EM CONTROL SYSTEM: - SYST. DE DÉPOLLUTION: EM, TC, DI, OC	
ENGINE MANUFACTURED BY: MOTEUR FABRIQUÉ PAR:	DISPLACEMENT: 7.3L CYLINDRÉE:	CURB IDLE RPM: RÉGIME DE RALENTI, TR / MIN: 675
NAVISTAR INTERNATIONAL TRANSPORTATION CORP.	THIS ENGINE HAS A PRIMARY INTENDED SERVICE APPLICATION AS A LIGHT HEAVY-DUTY DIESEL ENGINE AND CONFORMS TO U.S. EPA, CANADIAN, AND CALIFORNIA REGULATIONS FOR 1994 MODEL YEAR AND IS CERTIFIED TO OPERATE ON DIESEL FUEL.	
	CE MOTEUR A ÉTÉ PRINCIPALEMENT CONÇU EN TANT QU'UN MOTEUR DIESEL ROBUSTE DE GAMME LÉGÈRE. IL EST CONFORME AUX RÈGLEMENTS CANADIENS APPLICABLES À L'ANNÉE DE MODÈLE 1994 ET EST CERTIFIÉ POUR FONCTIONNER AU CARBURANT DIESEL.	

10

EMISSION LABEL

- The emission label is located on the Right Valve Cover and identifies the engine model, horsepower, and fuel delivery rate.

HEUI FUEL SYSTEM OPERATION

TABLE OF CONTENTS

HEUI FUEL SYSTEM OPERATION	11
SYSTEM OVERVIEW.....	12
RATE & TIMING CONTROL.....	13
HIGHER INJECTION PRESSURE	13
FIVE MAJOR COMPONENTS	14
POWERTRAIN CONTROL MODULE (PCM)	15
INJECTOR DRIVE MODULE (IDM)	16
HIGH PRESSURE OIL SUPPLY PUMP	17
INJECTION PRESSURE REGULATOR (IPR)	17
HEUI INJECTOR	18
• ELECTRONIC SOLENOID.....	19
• POPPET VALVE	19
• INTENSIFIER PISTON & PLUNGER.....	20
• NOZZLE ASSEMBLY	20
STAGES OF INJECTION	21
FILL CYCLE.....	21
INJECTION.....	22
END OF INJECTION DRAIN CYCLE.....	23
HEUI ELECTRONIC CONTROL SYSTEM	24
SENSORS	25
ACCELERATOR POSITION SENSOR (APS).....	26
CAMSHAFT POSITION SENSOR (CMP)	27
INJECTION CONTROL PRESSURE SENSOR (ICP).....	28
MANIFOLD ABSOLUTE PRESSURE SENSOR (MAP).....	29
ENGINE OIL TEMPERATURE SENSOR (EOT).....	30
INTAKE AIR TEMPERATURE SENSOR (IAT)	31
BAROMETRIC PRESSURE SENSOR (BARO)	32
EXHAUST BACK-PRESSURE SENSOR (EBP)	33
POWERTRAIN CONTROL MODULE (PCM).....	34
ACTUATORS.....	35
INJECTION PRESSURE REGULATOR (ACTUATOR)	36
IPR VALVE OPERATIONS	36
EXHAUST BACK-PRESSURE REGULATOR	36
ENGINE OFF	36
ENGINE CRANKING	37
ENGINE RUNNING	38

HEUI FUEL SYSTEM OPERATION

HEUI

HYDRAULICALLY ACTUATED
ELECTRONIC CONTROLLED
UNIT
INJECTOR

11

SYSTEM OVERVIEW

- Demands for greater fuel economy and lower exhaust emissions, in the 90's and beyond, require improved fuel system performance. The HEUI system (Hydraulically Actuated, Electronically Controlled, Unit Injection) meets these requirements. Three critical factors that lead to enhanced performance are:
- RATE OF CONTROL
- TIMING CONTROL
- HIGHER INJECTION PRESSURES

HEUI FUEL SYSTEM OPERATION

RATE CONTROL

- HEUI IS HYDRAULICALLY ACTUATED
- DOES NOT DEPEND ON ENGINE SPEED

12

RATE CONTROL

- The rate of injection can be controlled to meet any engine condition.
- Because the HEUI is hydraulically actuated rather than mechanically actuated, its rate of injection does not depend on engine speed.

TIMING CONTROL

- Both start and end of injection are electronically controlled.
- Unlike conventional electronically controlled mechanically actuated unit injectors, the HEUI plunger does not move until the solenoid is energized.
- This means that plunger movement is not limited to the speed or duration of a cam lobe.

TIMING CONTROL

BOTH START AND END OF INJECTION ARE ELECTRONICALLY CONTROLLED

13

HIGHER INJECTION PRESSURE

- AN INTENSIFIER PISTON IN THE HEUI
- MULTIPLIES HYDRAULIC FORCE ON THE PLUNGER

14

HIGHER INJECTION PRESSURES

- An intensifier piston in the HEUI multiplies hydraulic force on the plunger.
- By varying hydraulic input pressure, injection pressure can be controlled in a range from 3,000 to 21,000 psi.
- These high pressures are available throughout the entire engine operating range, at idle, as well as, high engine speeds.

13

HEUI FUEL SYSTEM OPERATION

MAJOR COMPONENTS

- **POWERTRAIN CONTROL MODULE (PCM)**
- **INJECTOR DRIVE MODULE (IDM)**
- **HIGH PRESSURE OIL SUPPLY PUMP**
- **INJECTION PRESSURE REGULATOR (IPR)**
- **INJECTORS (HEUI)**

15

THE HEUI SYSTEM CONSISTS OF FIVE MAJOR COMPONENTS:

- **POWERTRAIN CONTROL MODULE (PCM)**
Previously referred to as EEC utilizing 104 pin connector.
- **INJECTOR DRIVE MODULE (IDM)**
Steps up signal from PCM to drive injectors.
- **HIGH PRESSURE OIL SUPPLY PUMP**
A separate high pressure pump with exclusive purpose to power injectors.
- **INJECTION PRESSURE REGULATOR (IPR)**
Located on high pressure pump, controlled by PCM.
- **INJECTORS (HUEI)**
One per cylinder under the valve covers.

HEUI FUEL SYSTEM OPERATION

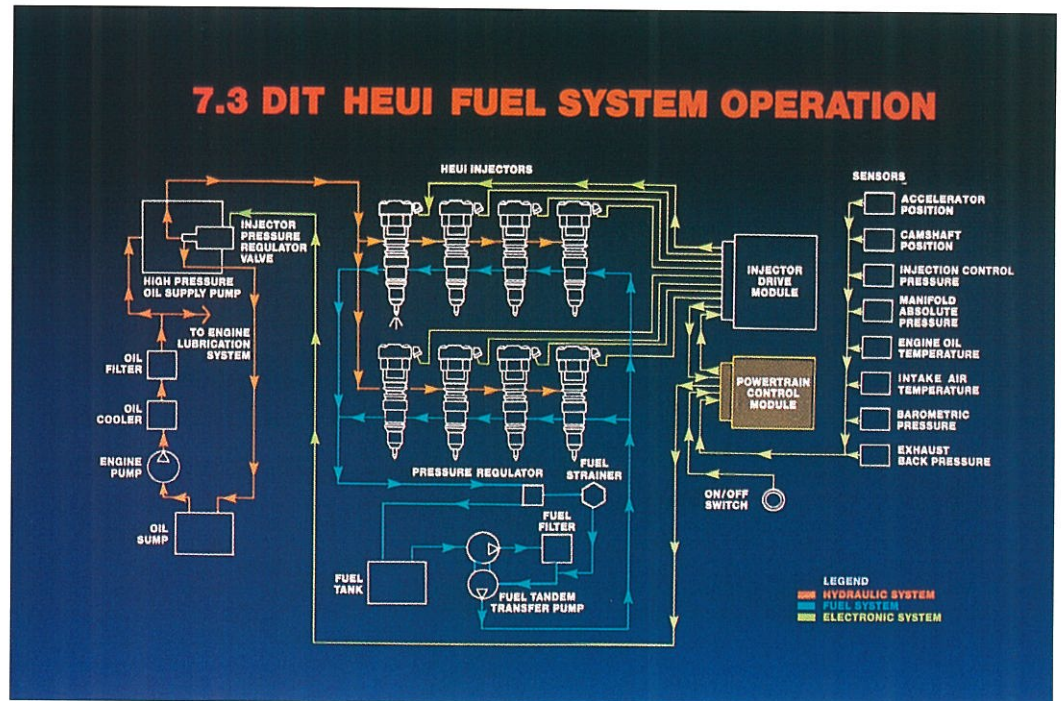

16

POWERTRAIN CONTROL MODULE (PCM)

- The PCM is a microprocessor which monitors various sensors from the vehicle and engine as it controls the operation of the entire fuel system.
- Sensors Monitored Include:
 - Accelerator Position Sensor (APS)
 - Camshaft Position Sensor (CMP)
 - Injection Control Pressure Sensor (ICP)
 - Manifold Absolute Pressure Sensor (MAP)
 - Engine Oil Temperature Sensor (EOT)
 - Intake Air Temperature Sensor (IAT)
 - Barometric Pressure Sensor (BARO)
 - Exhaust Back-Pressure Sensor (EBP)

15

HEUI FUEL SYSTEM OPERATION

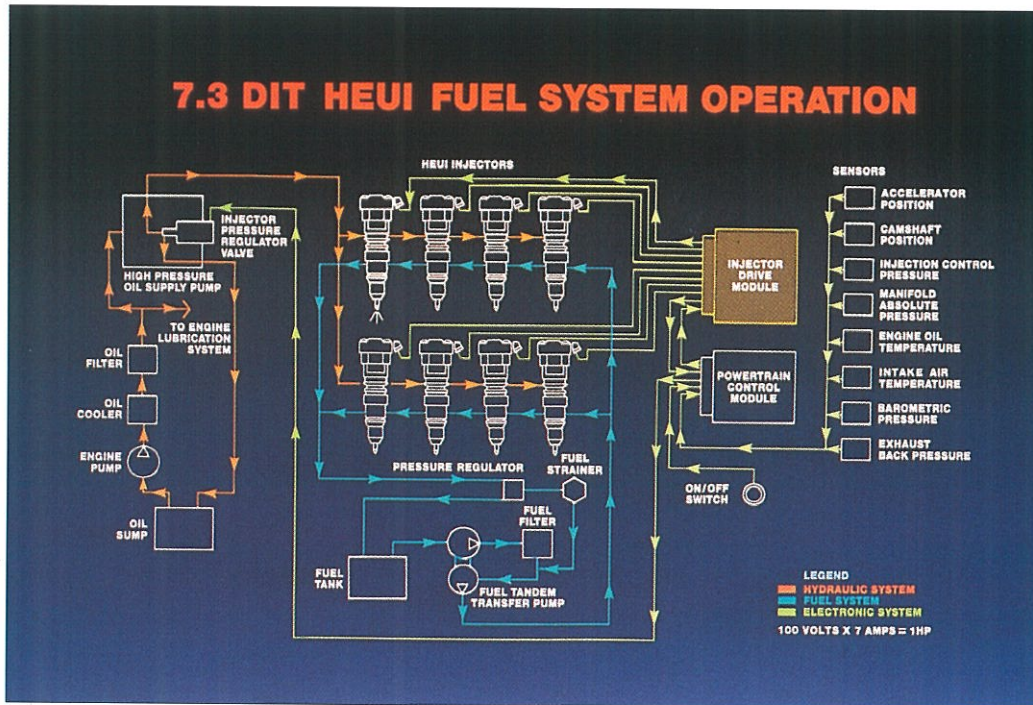

17

INJECTOR DRIVE MODULE (IDM)

- The IDM sends a precisely controlled current pulse to energize the injector solenoid.
- The timing and duration of the IDM pulse are controlled by the PCM.
- The IDM pulse consists of 100 Volts, 7 Amps, equal to 1 horsepower per injection.

HEUI FUEL SYSTEM OPERATION

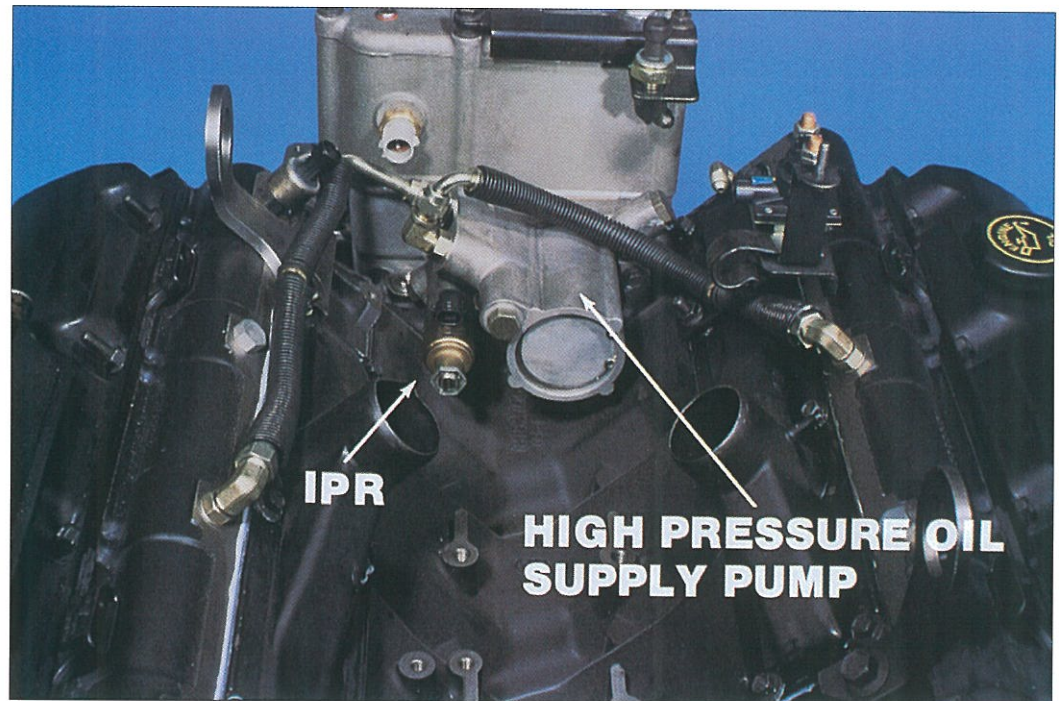

18

- In addition to the crankshaft driven gerotor oil pump that supplies lube oil to the engine, the fuel system features a high pressure lube pump and an injection pressure regulator.

HIGH PRESSURE OIL SUPPLY PUMP

- The hydraulic supply pump is a seven piston fixed displacement axial piston pump.

INJECTION PRESSURE REGULATOR (IPR)

- The IPR is an electrically operated dump valve which closely controls pump output pressure, between 450 and 3,000 psi, by dumping excess flow to the return circuit.
- The IPR is mounted on the high pressure oil pump.

17

HEUI FUEL SYSTEM OPERATION

HEUI INJECTOR



19

HEUI INJECTOR

- The HEUI Injector is hydraulically actuated by high pressure engine oil supplied by the high pressure oil pump.
- The Injector has four major components which contribute to higher injection pressure needed to satisfy increased customer expectations for performance, while improving fuel economy and meeting emissions regulations.
 - Solenoid
 - Poppet Valve
 - Intensifier Piston and Plunger
 - Nozzle Assembly

HEUI FUEL SYSTEM OPERATION

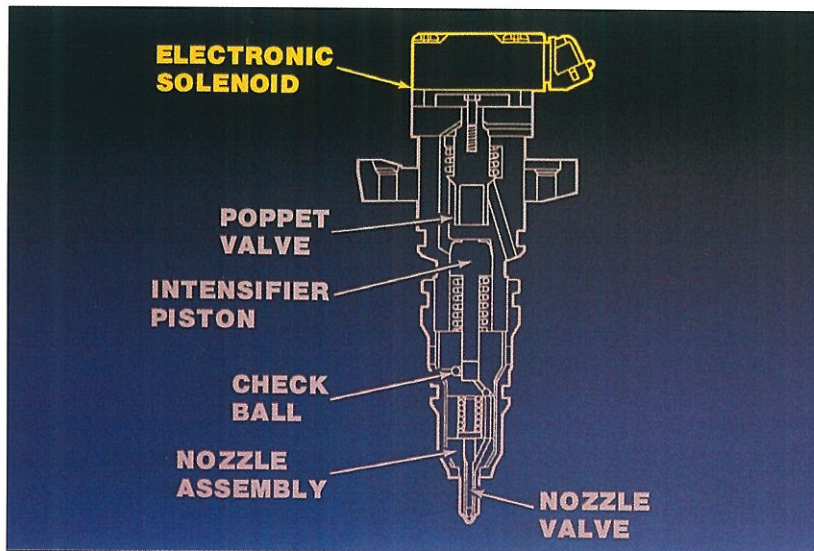

20

ELECTRONIC SOLENOID

- The solenoid is a very fast acting electro-magnet, which when energized, pulls the poppet valve off its seat.
- The injector is actuated 27 times per second at rated speed.
- 100 VOLTS • 7 AMPS
1 HORSEPOWER

POPPET VALVE

- The poppet valve is held on its lower seat by a spring. In this closed position, high pressure inlet oil is blocked and the intensifier cavity is opened to drain.
- When the solenoid is energized, the poppet is quickly lifted off its lower seat to its upper seat. The path to drain is closed and the inlet for high pressure oil is opened.

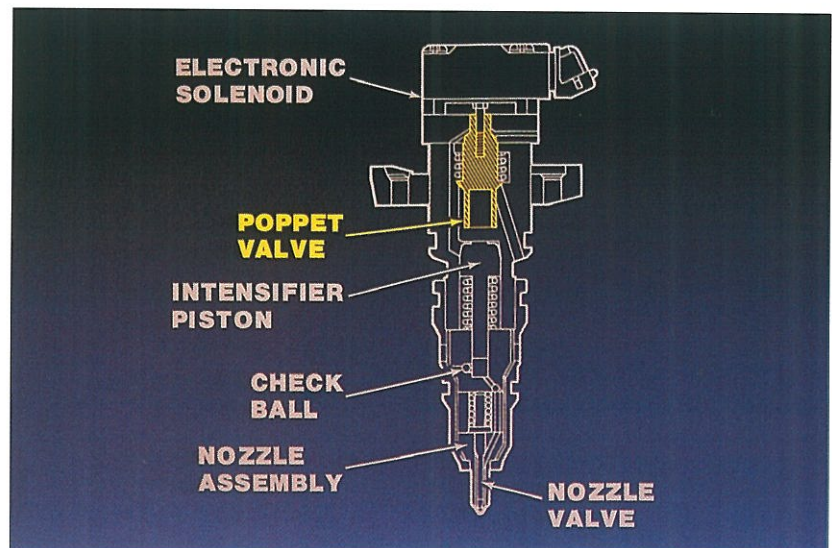

21

HEUI FUEL SYSTEM OPERATION

INTENSIFIER PISTON AND PLUNGER

- When the poppet valve opens the inlet port, high pressure oil enters the injector and acts on the top of the intensifier piston. Pressure builds on the intensifier, pushing it and the plunger down.
- The intensifier is 7 times larger in surface area than the plunger; providing an equal multiplication of force, i.e. injection pressure.
- The downward movement of the plunger pressurizes the fuel in the plunger cavity, causing the nozzle to open.

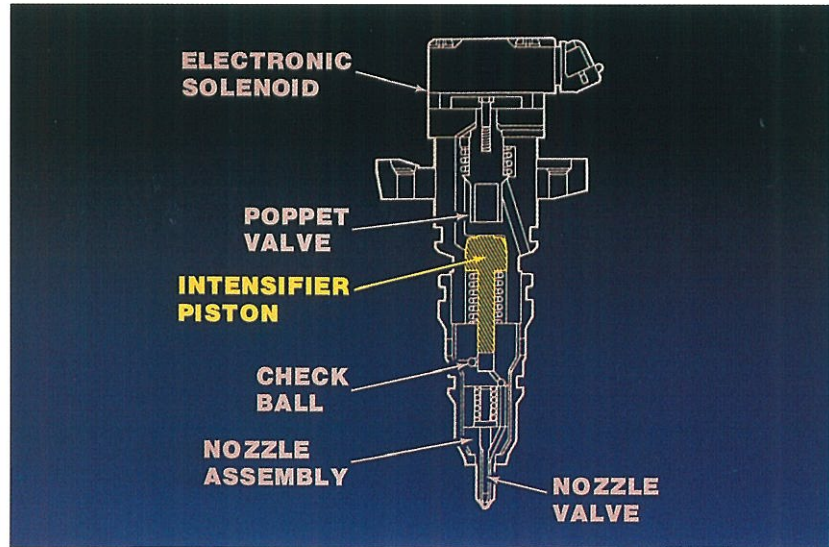

22

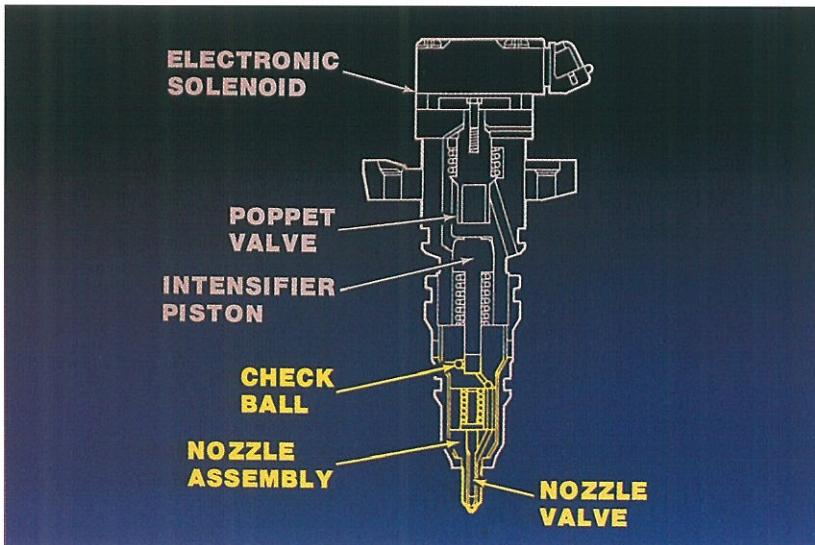

23

NOZZLE ASSEMBLY

- The nozzle assembly is of conventional design with the exception of the fill check. This check ball seats and seals during the downward stroke of the plunger to prevent leakage of the high pressure fuel.
- During the return stroke, it unseats allowing the plunger cavity to fill.
- The nozzle valve is an inwardly opening type which lifts off its seat when pressure overcomes the spring force. Fuel is then atomized at high pressure through the nozzle tip.

HEUI FUEL SYSTEM OPERATION

THREE STAGES OF INJECTION

- **FILL CYCLE**
- **INJECTION**
- **END OF INJECTION**

24

STAGES OF INJECTION

- THERE ARE THREE STAGES OF INJECTION WITH THE HEUI:
- **FILL CYCLE**
- **INJECTION**
- **END OF INJECTION**

FILL CYCLE

- During pre-injection all internal components have returned to their spring loaded positions. The poppet valve is blocking high pressure oil from entering the injector.
- The plunger and intensifier are at the top of their bore and the plunger cavity is full of fuel. Fuel pressure in the plunger cavity is the same as fuel gallery pressure, 40 to 70 psi.

FILL CYCLE

LEGEND
■ **ATMOSPHERIC PRESSURE**
■ **HIGH PRESSURE OIL**
■ **FUEL SUPPLY PRESSURE**

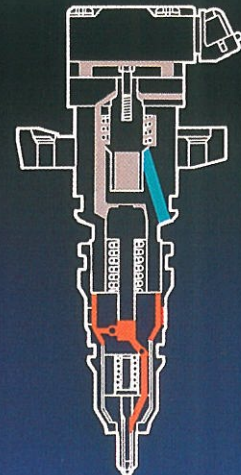

25

HEUI FUEL SYSTEM OPERATION

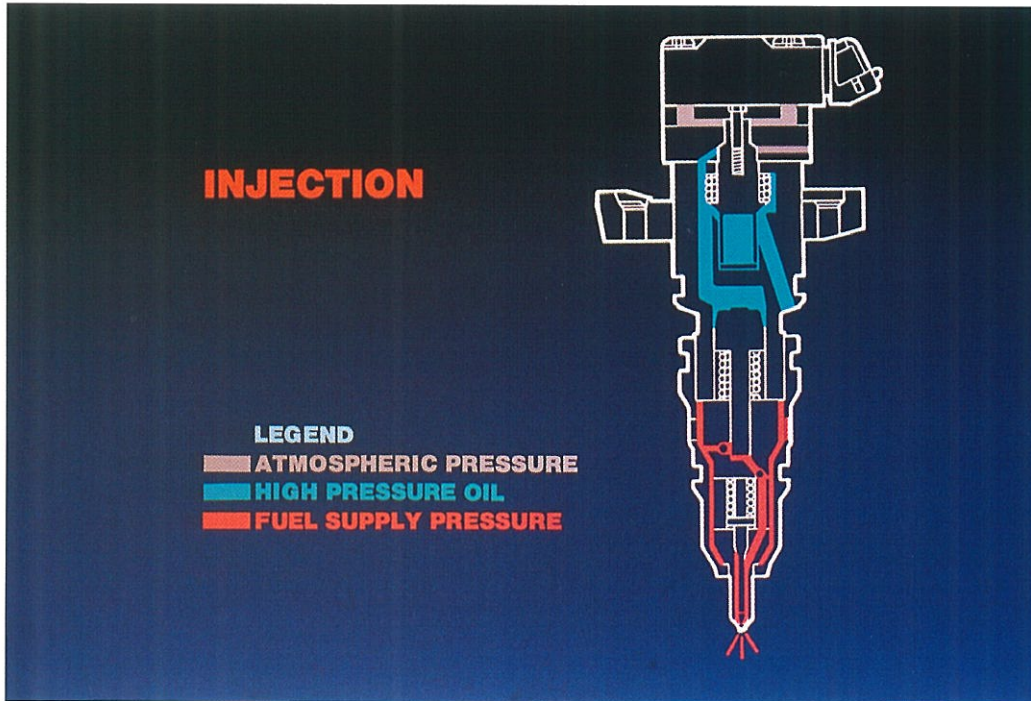

26

INJECTION

- When the PCM determines that the injector should be fired, the following sequence of events occur:
- PCM sends Fuel Delivery Control Signal (FDCS) to IDM.
- IDM sends electric current pulse to injector solenoid.
- Solenoid is fully energized almost instantly creating a strong magnetic pull on the armature.
- Magnetic pull of solenoid overcomes spring tension holding the poppet closed.
- Poppet is quickly raised off its seat.
- Upper poppet land closes off path to drain.
- Lower land opens poppet chamber to incoming high pressure oil.
- High pressure oil flows around poppet to the top of intensifier piston.
- Pressure on the top of the intensifier forces it down along with the plunger. The downward movement of the plunger pressurizes the fuel in the plunger cavity and nozzle. When the fuel pressure reaches Valve Opening Pressure (VOP) of about 2,700 psi, the nozzle valve lifts off its seat and injection begins.
- Injection pressures may be as high as 21,000 psi depending on engine requirements.

HEUI FUEL SYSTEM OPERATION

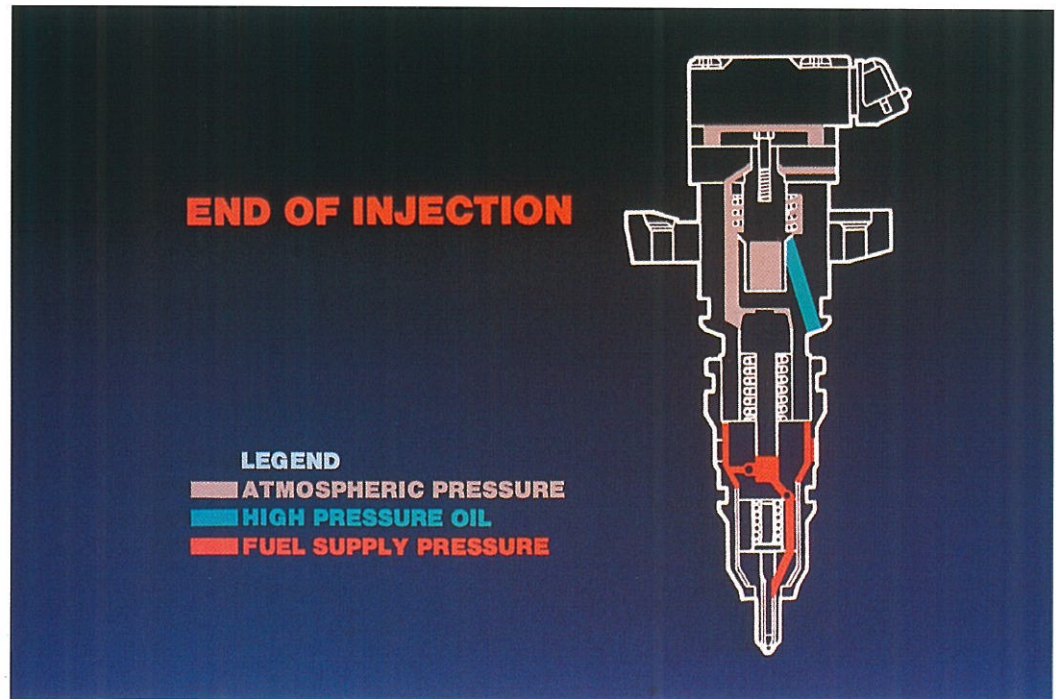

27

END OF INJECTION DRAIN CYCLE

- The end of the injection cycle begins when the PCM terminates the fuel delivery control signal to the IDM. The IDM then terminates the electric pulse to the solenoid. The following events occur:
 - The magnetic field of the solenoid collapses and is no longer able to overcome poppet spring tension to hold the poppet off its seat.
 - The poppet closes, shutting off high pressure oil from entering the injector.
 - When the poppet is seated, the upper land of the poppet opens the poppet cavity to drain.
 - Pressurized oil in the intensifier chamber and poppet chamber flows upward around the poppet seat, through the vent holes in the poppet sleeve and out the adapter drain hole.
- The pressure of the fuel in the plunger cavity exerts an upward force on the plunger and intensifier. As the pressure of the pressurized oil above the intensifier drops, so does the downward force on the intensifier.
- The upward force from the pressurized fuel almost instantly becomes greater than the downward force on the intensifier so the downward motion of the intensifier and plunger stops.
- When the plunger stops, fuel flow also stops and spring tension closes the nozzle valve.

23

HEUI FUEL SYSTEM OPERATION

ELECTRICAL COMPONENTS

- **SENSORS**
- **POWERTRAIN CONTROL MODULE**
- **ACTUATORS**

28

HEUI ELECTRONIC CONTROL SYSTEM

- Let's take a closer look at the electronic components that control the HEUI Injectors. There are three basic types of components:
 - SENSORS
 - POWERTRAIN CONTROL MODULE
 - ACTUATORS
- These components and their associated harnesses, form a control system that determines optimum injection timing, injection pressure, injection duration and fuel delivery.

HEUI FUEL SYSTEM OPERATION

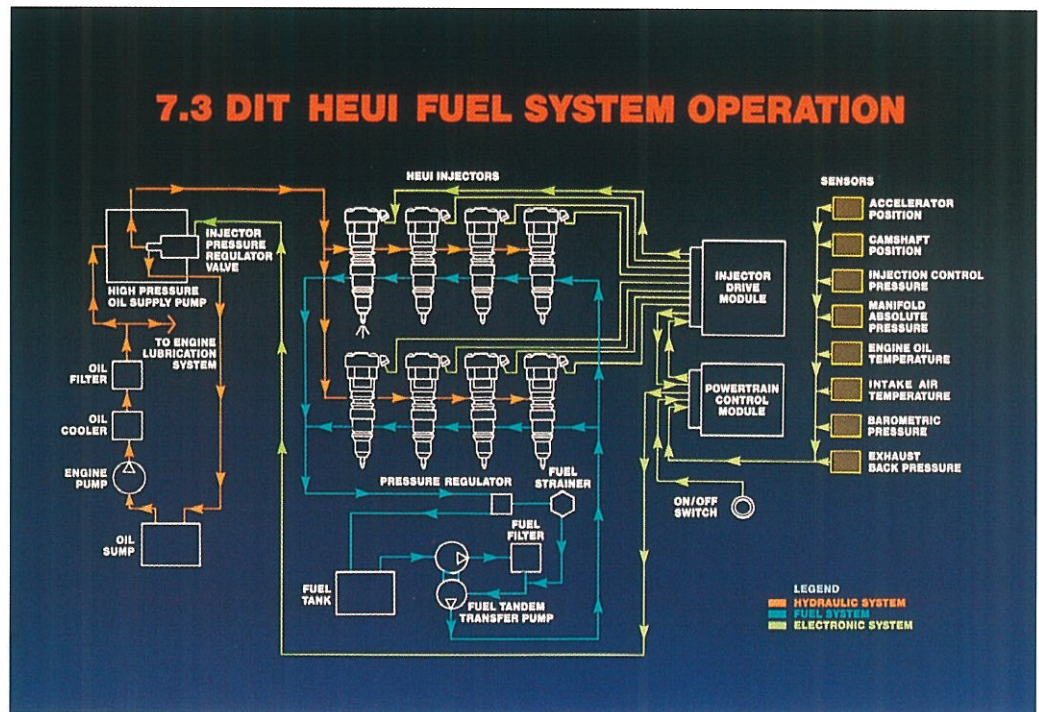

29

SENSORS

- The engine has eight sensors which constantly monitor performance and operating conditions.
- The job of each sensor is to accurately monitor a specific engine condition and generate a signal voltage to send through the vehicle wiring harness to the PCM
- The sensors provide the information necessary for the PCM to make decisions to control engine performance.

HEUI FUEL SYSTEM OPERATION

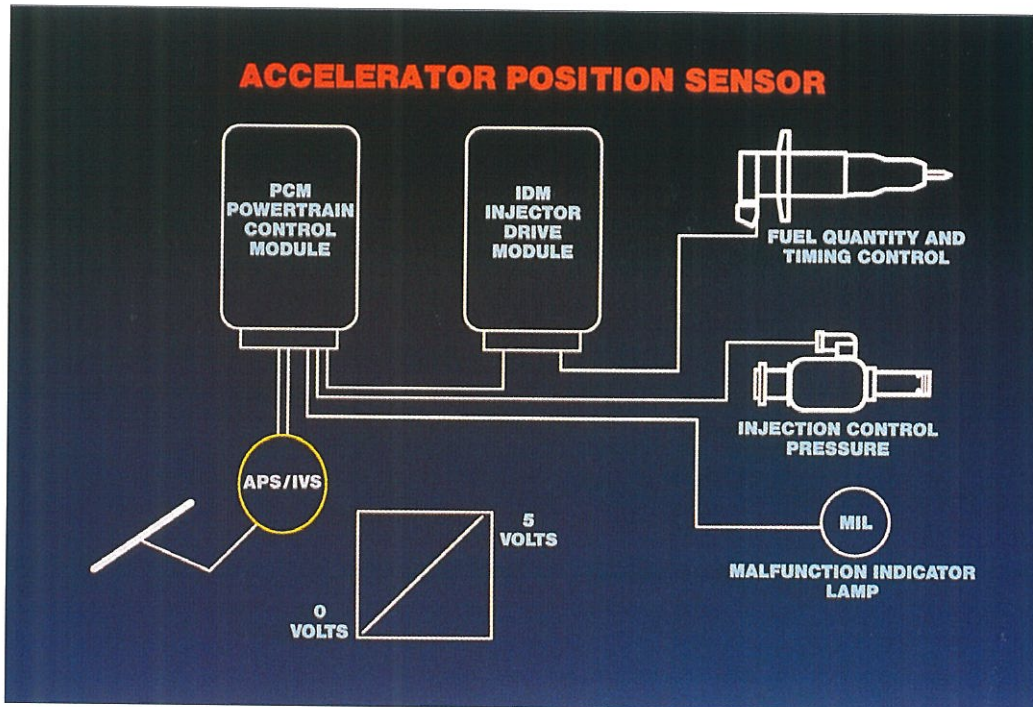

30

ACCELERATOR POSITION SENSOR (APS)

- The accelerator position sensor (APS) attached to the pedal assembly, provides the PCM with the driver's demand for power.
- The APS signal is used in calculating desired fuel quantity, injector timing and injection control pressure.
- The idle validation switch (IVS) provides the PCM with a redundant signal to verify when the pedal is in the idle position.
- An APS signal that is detected out of range, high or low, by the PCM will cause the engine to ignore the APS signal and will only allow the engine to operate at low idle.
- If a disagreement in the state of IVS and APS is detected by the PCM the engine will be allowed to operate at low idle only and a fault code will be registered by the on board diagnostics.

HEUI FUEL SYSTEM OPERATION

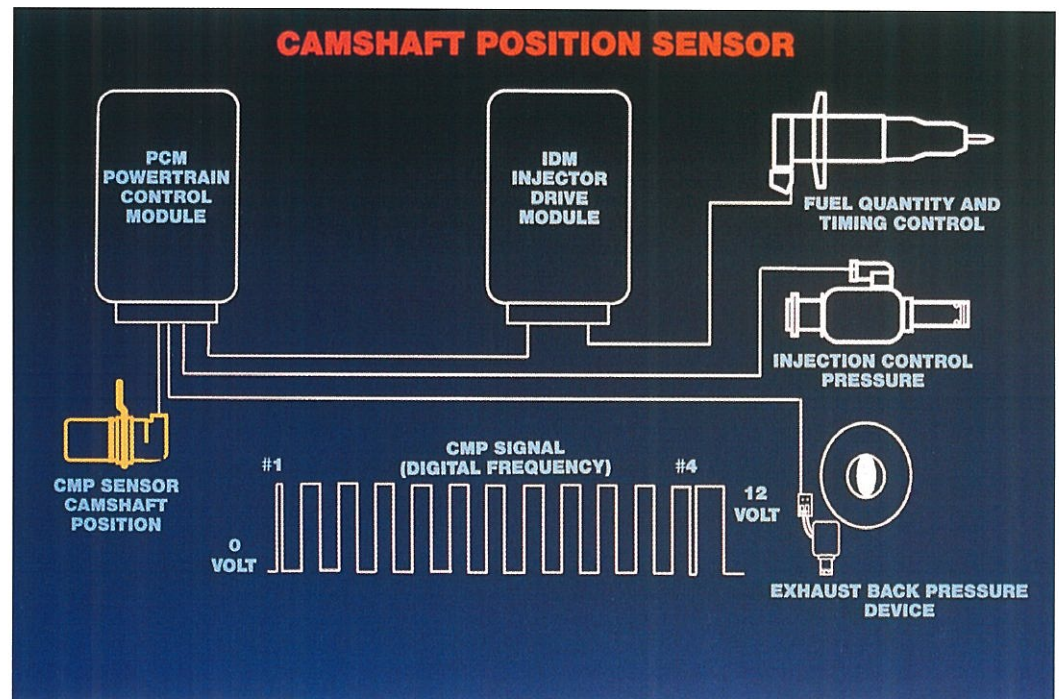

31

CAMSHAFT POSITION SENSOR (CMP)

- The CMP (Camshaft Position) sensor is a hall effect type sensor, located in the front cover. This generates a digital frequency as windows in a target wheel, on the cam gear, pass through its magnetic field.
- The frequency of the windows passing by the sensor, as well as, the width of selected windows allows the PCM to detect engine speed and cylinder/piston position.
- An inactive CMP signal during cranking is detectable by the PCM.
- An inactive CMP signal will cause a no start condition.
- The CMP sensor can be made inactive by a faulty ground.
- A corresponding fault code will be set if a defect is found by the on board diagnostics.

HEUI FUEL SYSTEM OPERATION

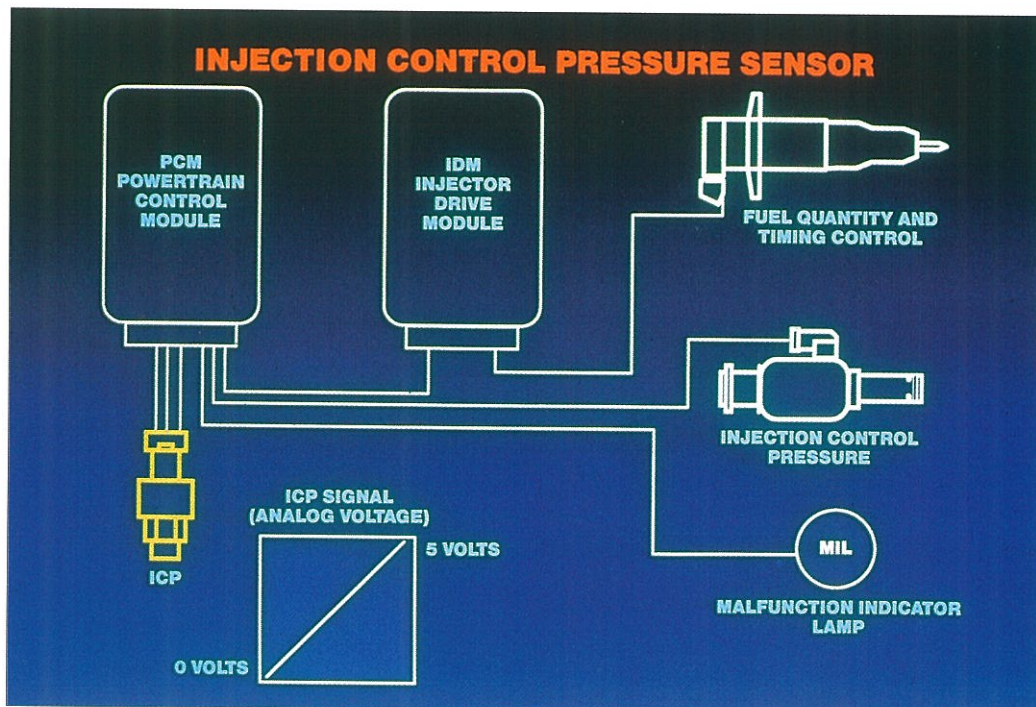

32

INJECTION CONTROL PRESSURE SENSOR (ICP)

- The ICP sensor provides the feedback signal for the closed loop control of the high pressure oil.
- The ICP sensor is a ceramic disk type pressure sensor that converts pressure into a 0 to 5 volt analog signal that the PCM uses to determine injection control pressure.
- The ICP sensor is threaded into the high pressure oil galleries on the left cylinder head.

HEUI FUEL SYSTEM OPERATION

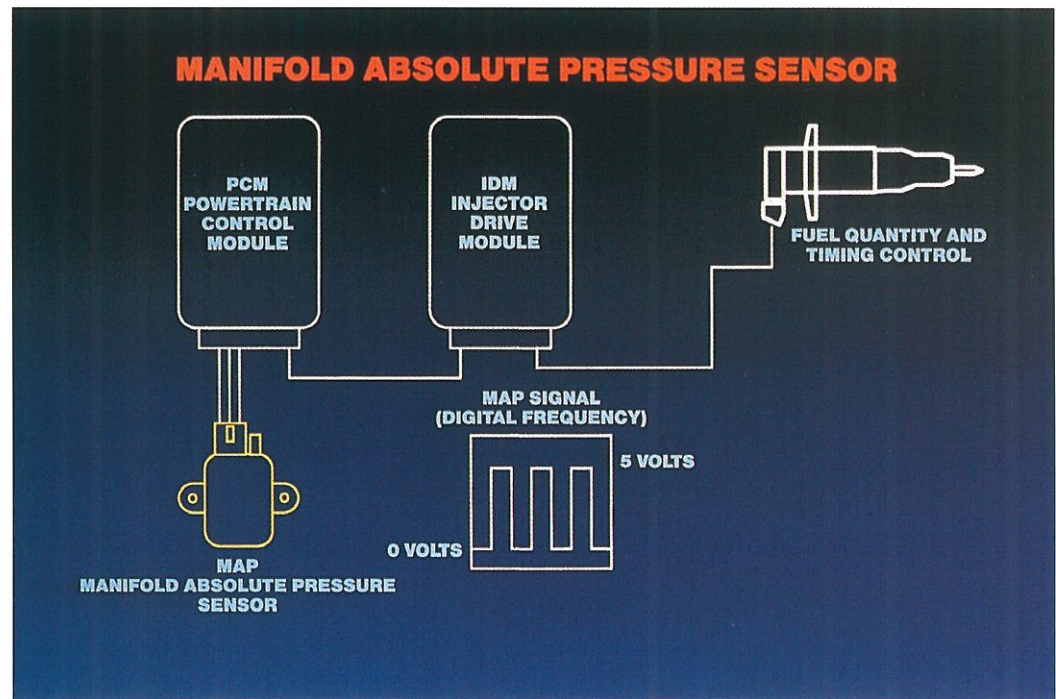

33

MANIFOLD ABSOLUTE PRESSURE SENSOR (MAP)

- The Manifold Absolute Pressure (MAP) sensor is a variable capacitance (pressure-sensing) disc, mounted on the cowl near the right hood hinge, that sends a frequency to the PCM relative to intake manifold pressure. The sensor frequency increases as pressure decreases.
- The MAP sensor allows the PCM to determine engine load to calculate fuel quantity.
- A MAP signal malfunction detected by the PCM will cause the PCM to ignore the MAP signal and calculate an estimated manifold pressure based on known engine conditions.
- A fault code can be set if the on board diagnostics detect a defect.

HEUI FUEL SYSTEM OPERATION

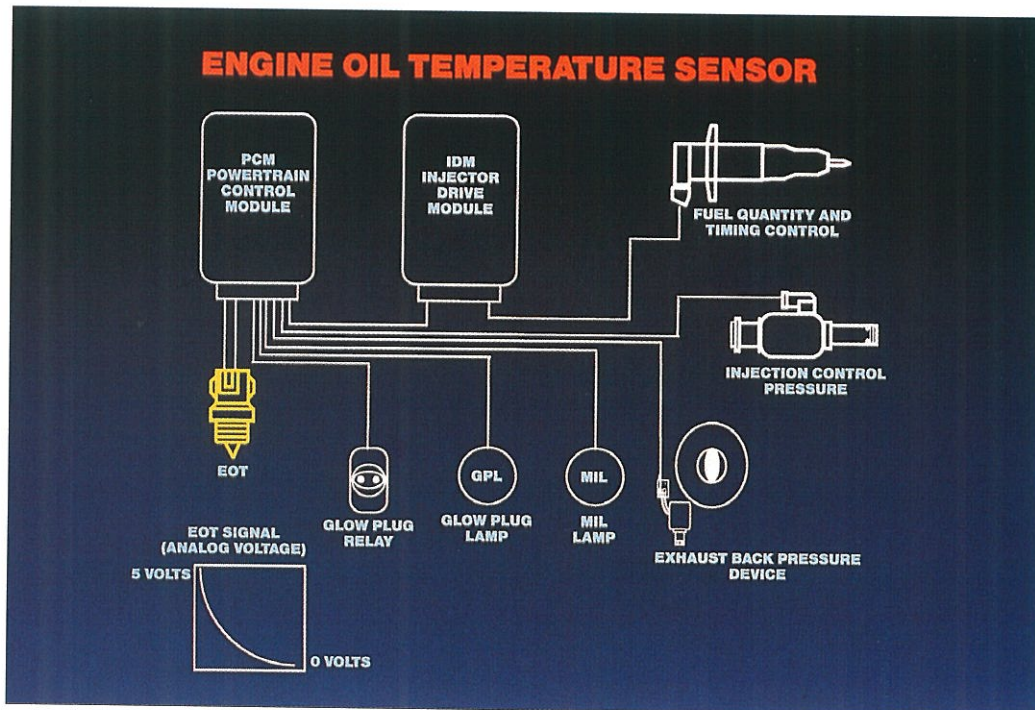

34

ENGINE OIL TEMPERATURE SENSOR (EOT)

- The Engine Oil Temperature (EOT) sensor is a thermister whose resistance decreases as engine oil temperature increases.
- The EOT signal is one of the sensors used by the PCM to calculate fuel quantity, injection timing, glow plug operation and exhaust back pressure.
- At oil temperatures below 122° F (50° C), low idle is increased to a maximum of 900 RPM to insure faster engine warm-up.
- Fuel quantity and timing is controlled throughout the total operating range to insure adequate torque and power are available.
- An EOT signal detected out of range, high or low, by the PCM will cause the PCM to ignore the EOT signal and assume an engine oil temperature of 68° F (20° C) for starting purposes and 212° F (100° C) for operating purposes.
- Engine oil temperature is measured in the reservoir.
- A fault code can be set if the on board diagnostics detects a defect.

HEUI FUEL SYSTEM OPERATION

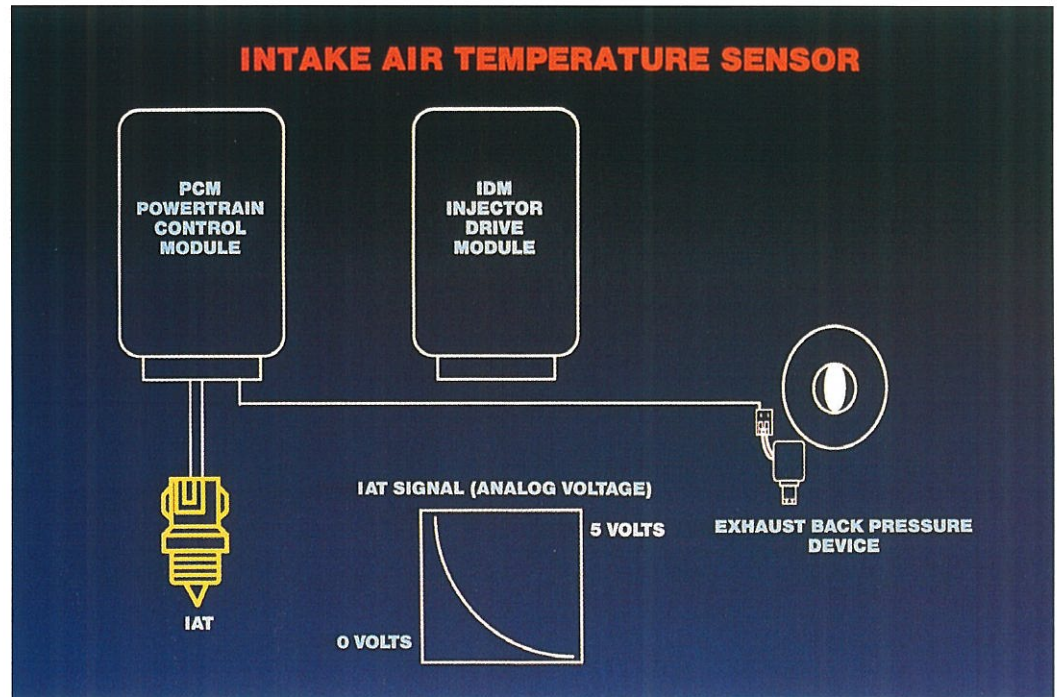

35

INTAKE AIR TEMPERATURE SENSOR (IAT)

- The Intake Air Temperature (IAT) sensor is a thermister whose resistance decreases as temperature increases.
- Mounted in the air cleaner, the IAT sensor's function is to provide ambient air temperature information to the PCM.
- The PCM uses IAT output voltage drops to enable exhaust back-pressure control for faster engine warmup.
- An IAT signal detected out of range, high or low, by the PCM will result in the PCM ignoring the signal and assuming an ambient air temperature of 59° F (15° C) while setting a fault code.
- The assumed ambient temperature of 59° F (15° C) will provide sufficient performance to return for service.

HEUI FUEL SYSTEM OPERATION

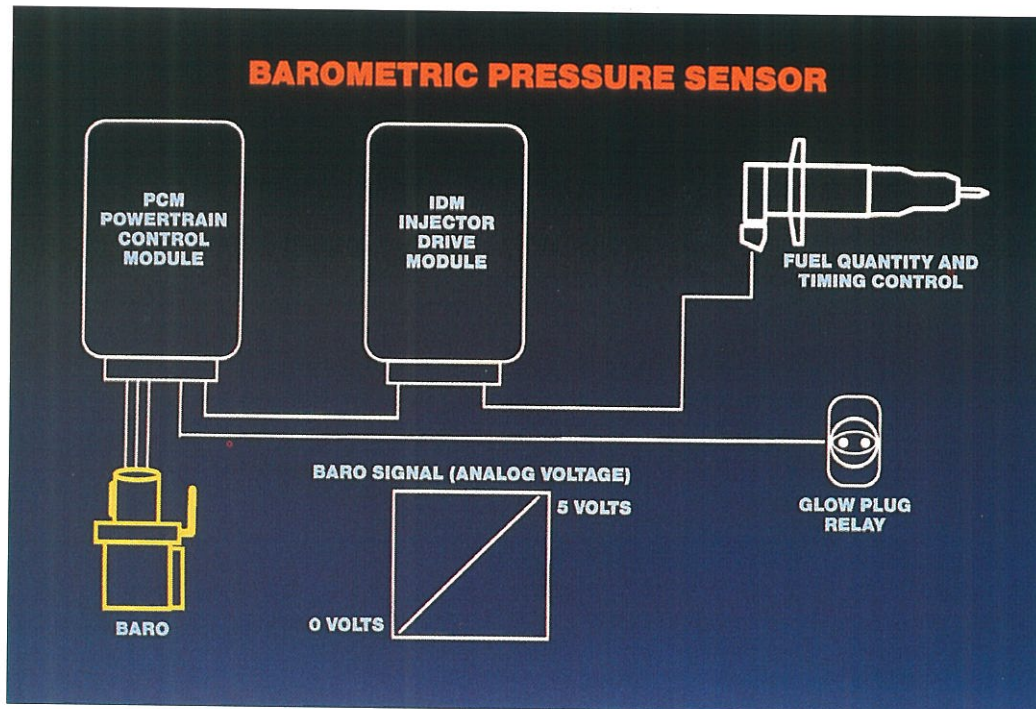

36

BAROMETRIC PRESSURE SENSOR (BARO)

- The Barometric Pressure (BARO) sensor is an analog device, located under the dash above the accelerator pedal, which senses atmospheric pressure which allows the PCM to compensate for altitude.
- The PCM uses this information to calculate injection timing and control glow plug "on" time.
- An open in the BARO sensor circuit will result in an out of range low signal to the PCM.
- Any other wiring faults will result in an out of range condition. The PCM will assume a default value of 14.5 psi (100 kPa).
- The assumed value of 14.5 psi will allow sufficient performance to return for service.

HEUI FUEL SYSTEM OPERATION

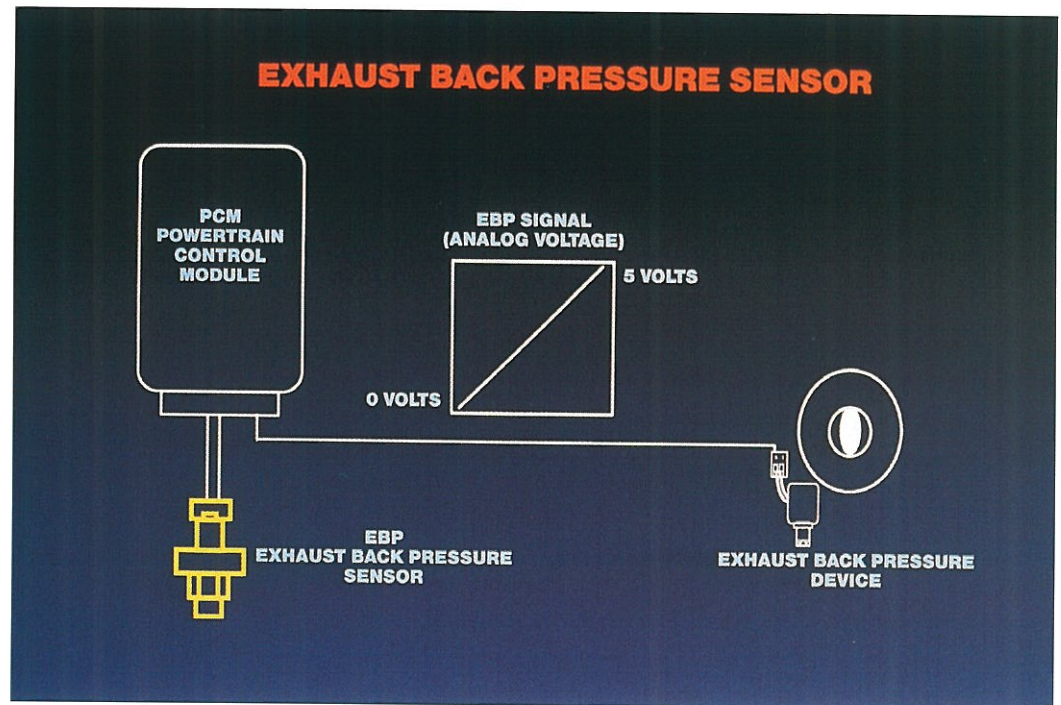

37

EXHAUST BACK-PRESSURE SENSOR (EBP)

- The Exhaust Back-Pressure (EBP) sensor measures pressure in the right exhaust manifold and is located next to the oil reservoir.
- This sensor is used in conjunction with the exhaust back-pressure regulator to form a closed loop exhaust back pressure control system. The EBP sensor is also used for diagnosis of the turbocharger.
- Exhaust back-pressure is controlled to provide more heat to the coolant for cab heating when ambient air temperature is below 45° F (7° C) and engine oil temperature is below 167° F (75° C) during low load, low speed operating conditions.
- An open or short in the EBP sensor wiring will result in a low out of range voltage at the PCM.

HEUI FUEL SYSTEM OPERATION

7.3 DIT HEUI FUEL SYSTEM OPERATION

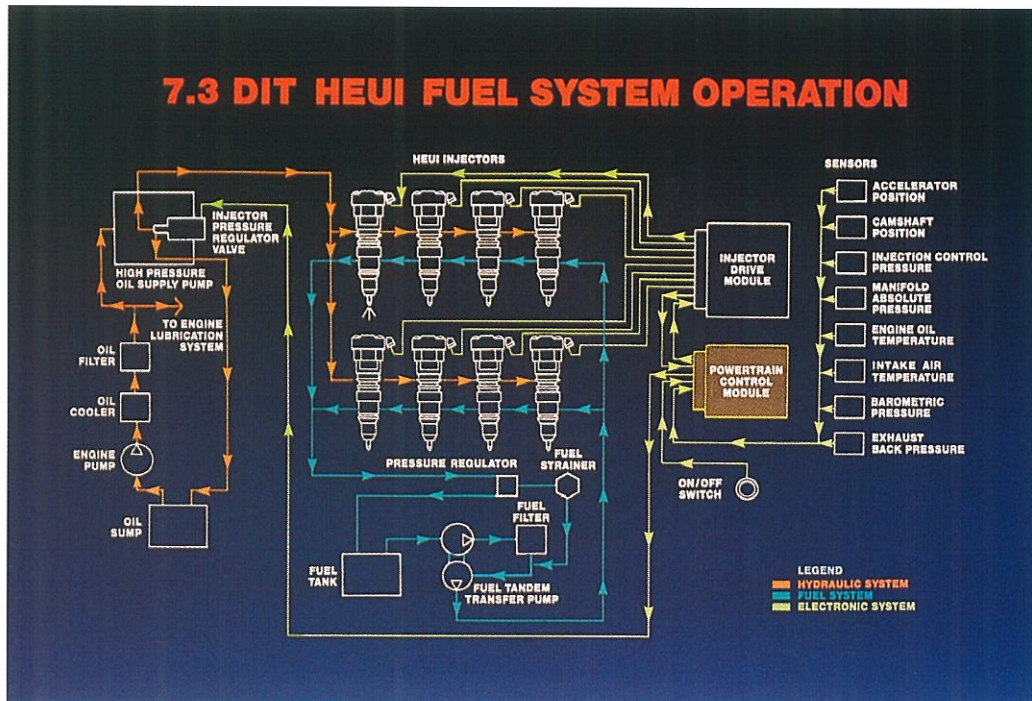

38

POWERTRAIN CONTROL MODULE (PCM)

- The control module (formerly called EEC) receives the input voltages from the various sensors. These input voltages are known as input signals.
 - The input signals are used by the control module to make decisions on how to control the engine.
 - These decisions are translated into output signals which are sent to the actuators to change engine performance.
- Sensors Monitored Include:
 - Accelerator Position Sensor (APS)
 - Camshaft Position Sensor (CMP)
 - Injection Control Pressure Sensor (ICP)
 - Manifold Absolute Pressure Sensor (MAP)
 - Engine Oil Temperature Sensor (EOT)
 - Intake Air Temperature Sensor (IAT)
 - Barometric Pressure Sensor (BARO)
 - Exhaust Back-Pressure Sensor (EBP)

HEUI FUEL SYSTEM OPERATION

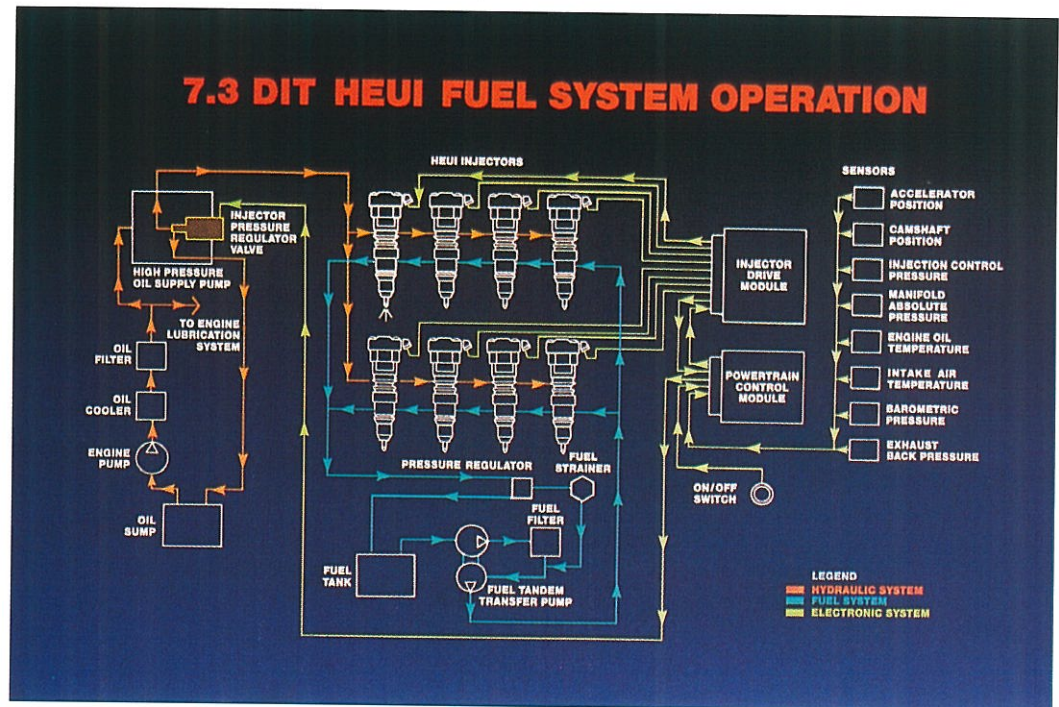

39

ACTUATORS

- Actuators convert electrical output signals from the powertrain control module to hydraulic or electrical work to control engine performance.

ACTUATORS INCLUDE:

- Injection Pressure Regulator
- Exhaust Back-Pressure Regulator

HEUI FUEL SYSTEM OPERATION

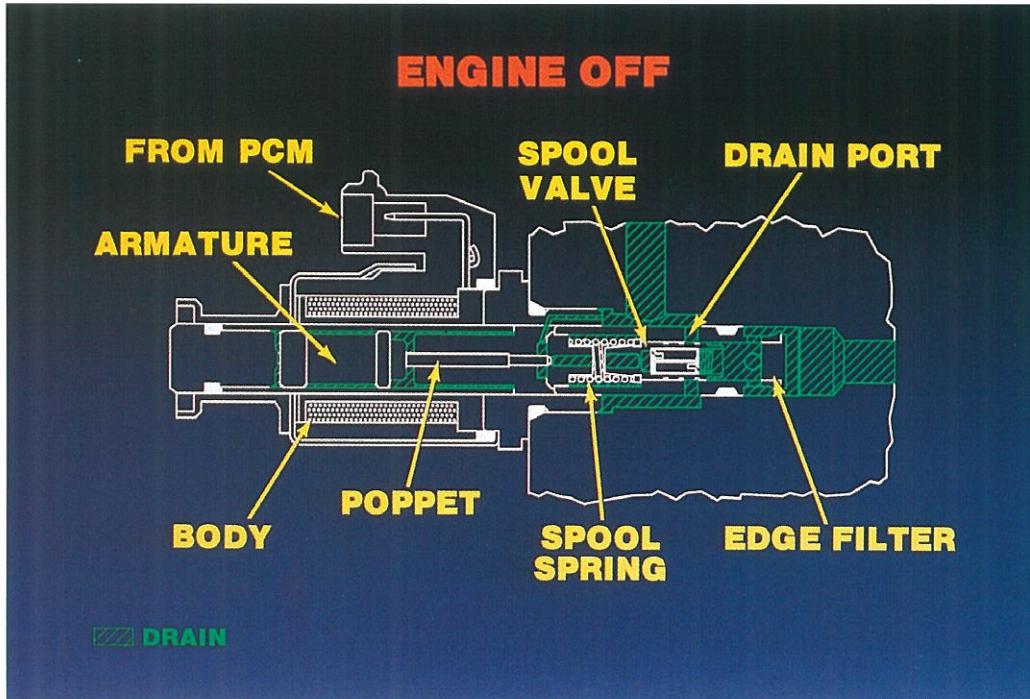

40

INJECTION PRESSURE REGULATOR (ACTUATOR)

- The IPR is an electronically controlled pilot operated (small flow that controls a larger flow) pressure control valve.
- The IPR controls pump outlet pressure in a range between 450 and 3000 psi. An electrical signal to the solenoid creates a magnetic field which applies a variable force on the poppet to control pressure.

EXHAUST BACK PRESSURE REGULATOR

- The Exhaust Back Pressure Regulator performs similar to the IPR, directing oil flow.
- Turbocharger lube oil is directed into a hydraulic chamber which activates the Exhaust Back Pressure device when the PCM commands exhaust back-pressure.

OPERATION-ENGINE OFF

- With the engine off, the valve spool is held to the right by the return spring and the drain ports are closed.

HEUI FUEL SYSTEM OPERATION

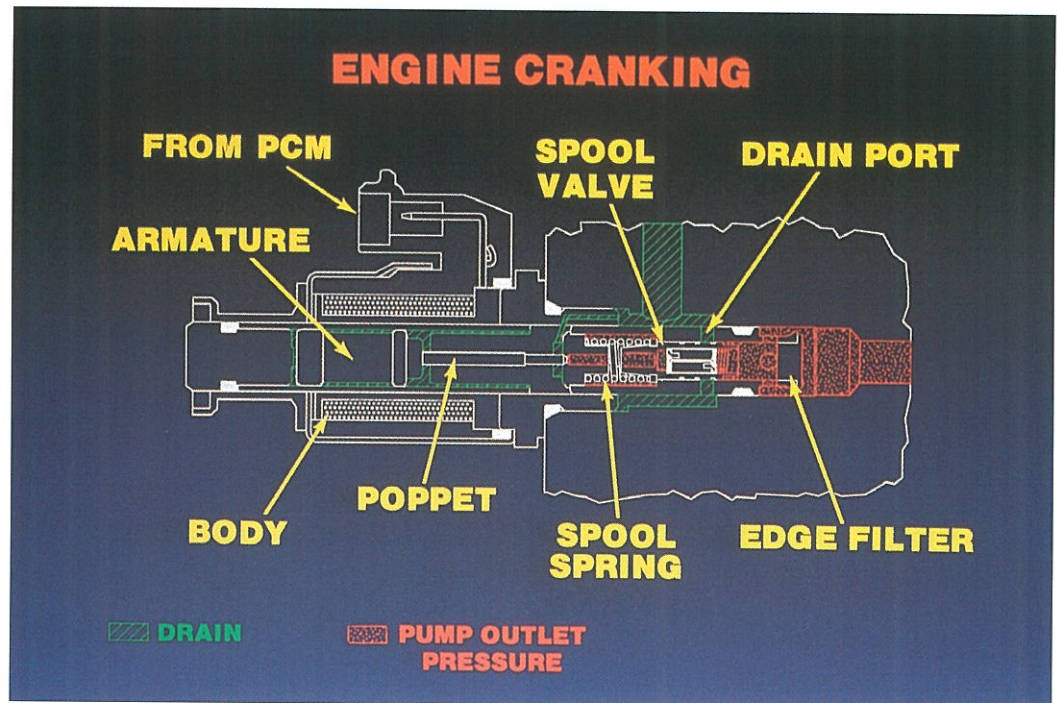

41

OPERATION - ENGINE CRANKING

- Approximately 1,500 psi of oil pressure is required to start an engine with oil temperature greater than 75°F.
- If the engine is cold, 2,750 psi of oil pressure is commanded by the PCM.
- Oil flow through the IPR is as follows:
 - Pump outlet pressure (red dots) enters the end of the body and a small amount of oil flows into the spool chamber through the pilot stage edge filter and control orifice in the end of the spool.
 - The combination of spool spring force and spool chamber pressure hold the spool to the right, closing the drain ports.
 - The electronic signal causes the solenoid to generate a magnetic field which pushes the armature to the right.
 - The armature exerts a force on the push pin and poppet holding the poppet closed, allowing spool chamber pressure to build.
 - All oil is directed to the pressure gallery in each cylinder head until the desired pressure is reached.

HEUI FUEL SYSTEM OPERATION

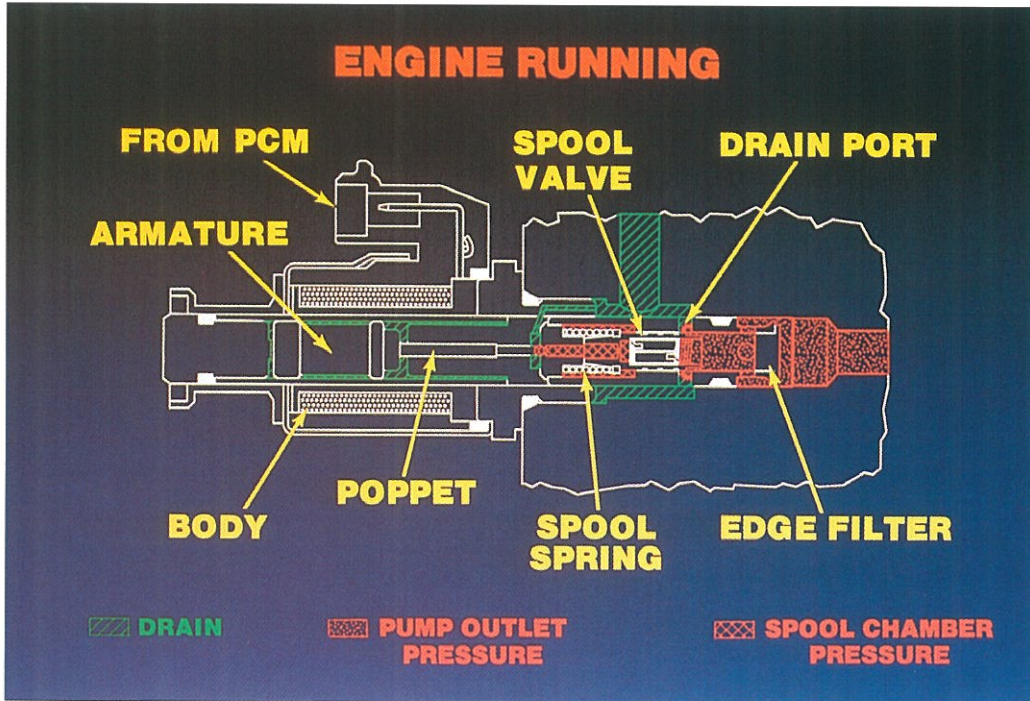

42

OPERATION - ENGINE RUNNING

- Once the engine starts, the PCM sends a signal to the IPR to give the gallery pressure desired. The injection control pressure sensor monitors actual gallery pressure.
- The PCM compares the actual gallery pressure to the desired gallery pressure and adjusts the signal to the IPR accordingly.
- The actual oil flow through the IPR during engine operation is as follows:
 - Pump outlet pressure (red dots) enters the end of the body and a small amount of oil flows into the spool chamber (red cross hatch) through the pilot stage filter and the control orifice in the spool.
 - The pressure in the spool chamber is controlled by adjusting the position on the poppet and allowing it to bleed off some of the oil in the spool chamber.
 - The position of the poppet is controlled by the strength of the magnetic field produced from the electrical signal from the PCM.
 - The spool responds to pressure changes in the spool chamber (left side of the spool) by changing positions to maintain a force balance between the right and left side of the spool. The spool position determines how much area of the drain ports is open.
 - The process of responding to pressure changes on either side of the spool occurs so rapidly that the spool is held in a partially open position and pump outlet pressure is closely controlled. The IPR allows infinitely variable control of pump outlet pressure between 450 psi and 3,000 psi.

SYSTEMS

TABLE OF CONTENTS

7.3 DIT SYSTEMS	39
LUBE SYSTEM FLOW CHART	40
LUBE SYSTEM, INJECTOR OIL SYSTEM	41
FUEL SYSTEM	42
FUEL PUMP & FUEL FILTER	43
FUEL PUMP & RETURN LINES	44
AIR FLOW SYSTEM	45
AIR FLOW CHART (Intake & Exhaust System)	45
COOLING SYSTEM FLOW CHART	46
GLOW PLUG SYSTEM	47

LUBE SYSTEM



43

LUBE FLOW CHART

- The lubrication system is pressure regulated, cooled and full flow filtered.
- In addition to providing engine lubrication, pressurized lube oil is used to control fuel delivery in the hydraulically actuated electronically controlled unit injectors.
- Lube oil is drawn from the oil sump through the pick-up screen and tube into the oil pump. The oil pump is a Gerotor type with the rotor portion driven directly by flats on the nose of the crankshaft.
- The pump housing is bolted to the front cover. Pump inlet and outlet passages are through ports in the front cover. Lube oil enters the oil cooler header through a passage in the front cover.
- The oil reservoir, used to maintain a ready supply of oil to the high pressure pump, is filled via two passages:
 - 1) For initial startup, oil is directed from the oil pump discharge port through a passage in the crankcase which also contains an anti-drain back check ball. This path replenishes oil to the high pressure pump during cold cranking to insure sufficient oil pressure to operate the injectors for quick starts.
 - 2) The primary reservoir oil supply is a continuous feed from the left bank tappet gallery up through the front cover and discharges oil near the top of the reservoir.
- Pressurized lube oil reaches the turbocharger bearings from the rear main oil gallery through a passage in the turbocharger pedestal (mounting pad). Oil drains from the turbocharger through another passage in the pedestal directly back to sump. This oil supply and drain eliminates need for external lube lines to the turbocharger.

LUBE SYSTEM

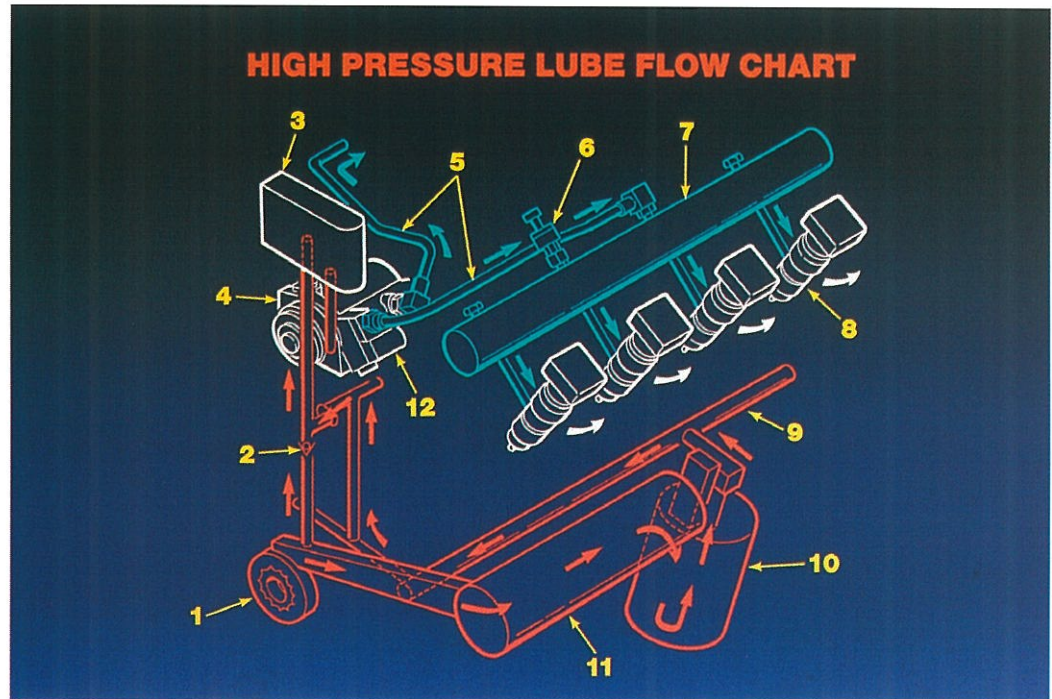

44

HIGH PRESSURE LUBE FLOW CHART INJECTOR OIL SYSTEM

1. Oil Pump (Gerotor)
2. Check Valve
3. Reservoir
4. High Pressure Pump
5. High Pressure Hoses
6. ICP Injection Control Pressure Sensor
7. Cylinder Head High Pressure Gallery
8. Injector (8)
9. Gallery (Crankcase Main)
10. Oil Filter
11. Oil Cooler
12. Injector Pressure Regulator (IPR)

- The reservoir makes available a constant supply of oil to a high pressure hydraulic pump mounted to the front cover located in the engine "V". The high pressure pump is a gear driven, seven plunger, swash plate pump. High pressure oil is delivered by the high pressure pump to oil galleries machined into the cylinder heads.

FUEL SYSTEM

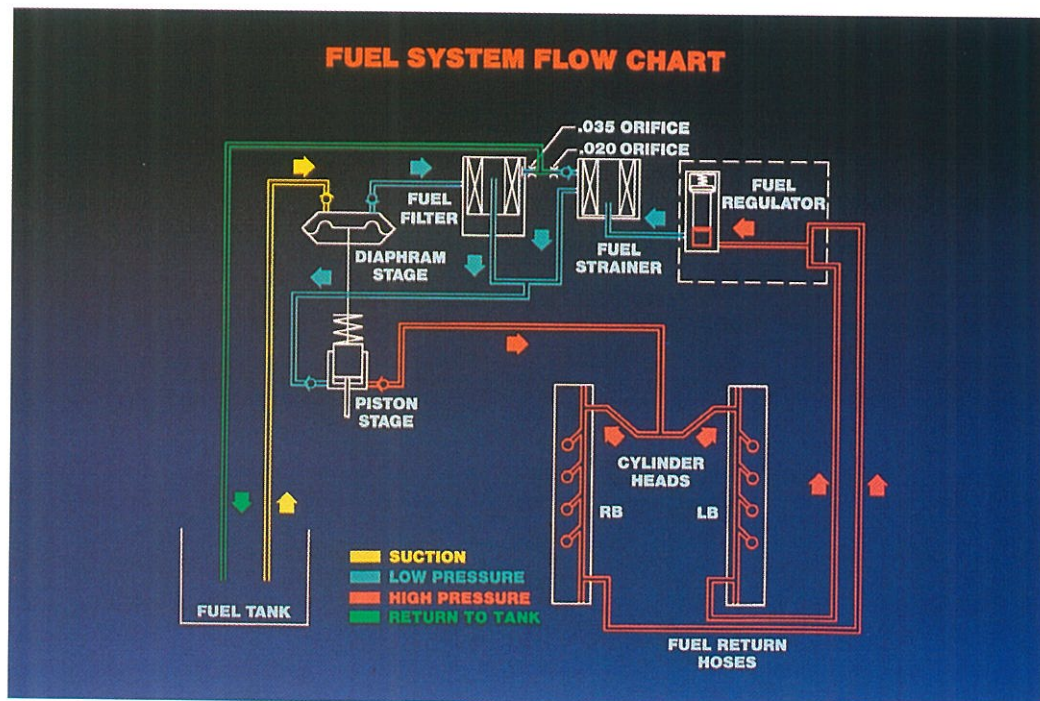

45

FUEL SYSTEM

- Fuel is drawn from the tank to the engine by the diaphragm stage of the tandem lift pump.
- The diaphragm stage pressurizes the fuel to 4-6 psi while pushing it into the filter housing.
- Filtered fuel is then directed to the piston stage of the tandem pump, where its pressure is increased to between 40-70 psi.
- The fuel is now directed through steel lines to the rear of each cylinder head, and it enters the fuel galleries.
- The fuel galleries intersect with the injectors and when the fill check unseats in the injector, the plunger cavity is filled with fuel pressurized to 40-70 psi.
- To maintain flow into the galleries, fuel return flow is directed to the fuel pressure regulator attached to the filter.
- The spring loaded spool valve regulates system pressure between 40-70 psi.
- At the regulator, some fuel passes through an orifice (.020") to continuously vent air from the system.
- Most of the fuel is directed back into the line delivering fuel to the piston side of the tandem pump.
- Any air trapped in the filter housing is vented through an orifice (.035") to the return to tank line

IMPORTANT

The nylon strainer insert located inside the strainer cup must be kept in place to prevent plugging of the 0.020 inch orifice. Should this orifice become plugged, engine performance may be adversely effected since the fuel system will not de-aerate properly.

FUEL SYSTEM

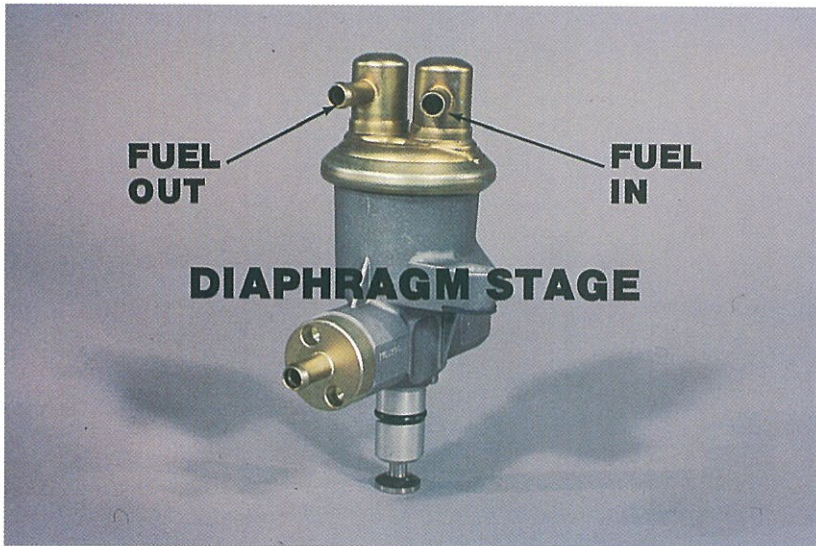

46

FUEL PUMP

- The 7.3 DIT incorporates a two stage fuel supply pump, i.e., diaphragm/vacuum and piston/pressure stages.
- The diaphragm stage of the tandem lift pump draws fuel from the tank and transfers it to the primary fuel filter housing. Fuel pressure created in the diaphragm stage is 4 to 6 psi.

FUEL FILTER

- Fuel is directed from the diaphragm stage of the tandem pump to the filter housing. It passes through the filter element to a standpipe in the center of the filter assembly. Clean fuel then passes to the inlet of the piston stage of the tandem pump.
- The fuel filter element is attached to the threaded filter cover. When clogged with debris the element can be separated from the cover and replaced with a new element.

IMPORTANT

The engine will not run without the fuel filter element in place. The standpipe in the center of the housing contains a shut-off valve which is open only when the filter element is in place.

- The base of the filter housing contains an electric heating element to warm fuel to prevent waxing during cold weather.
- Also located in the base of the housing is a sensor to detect presence of water in the fuel. When sufficient water has collected in the bottom of the filter, the sensor illuminates a water in fuel lamp on the instrument panel, indicating the need for the operator to stop the vehicle, turn off the engine, and drain the water from the housing.

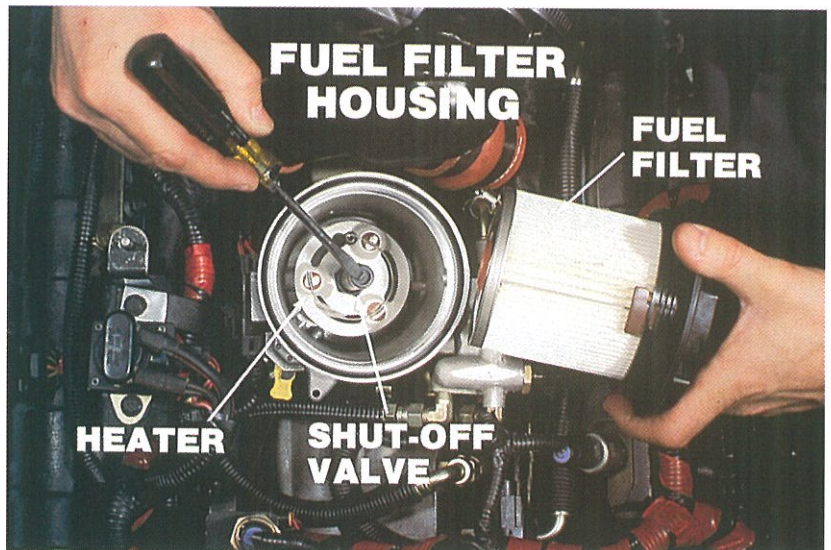

47

FUEL SYSTEM

FUEL PUMP

- The piston stage of the tandem pump raises fuel pressure to 40 to 70 psi to insure proper filling of the injectors.
- Fuel from this stage is delivered through steel lines to the back of each cylinder head. This supplies fuel to a gallery drilled in each head.
- Cross drillings in the heads connect the fuel gallery to each injector.

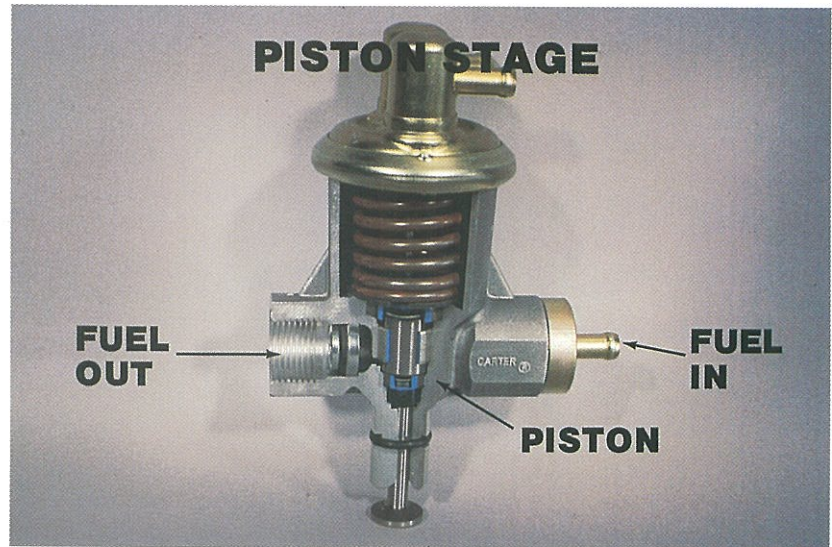

48

● FUEL RETURN LINES

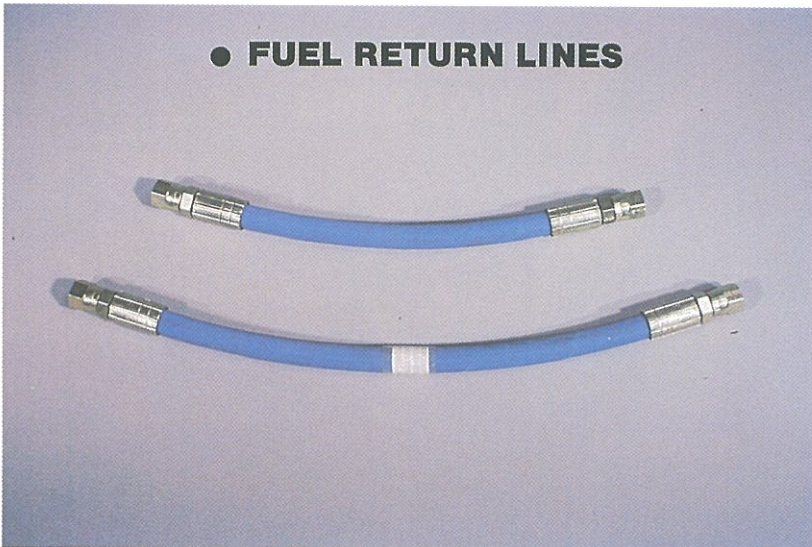

49

RETURN LINES

- Excess fuel from the two fuel galleries is piped through hoses, from the front of each head to the pressure regulator located on the left side of the filter housing.
- These hoses, of a special rubber compound, provide flexibility in the fuel system, by absorbing and smoothing pressure pulses from the piston stage of the pump.

IMPORTANT

Use only certified replacement hoses of the correct part number when repairing the 7.3 DIT fuel system. Substituted hoses may not meet pressure and/or flexibility requirements needed for proper fuel system operation.

AIR FLOW SYSTEM

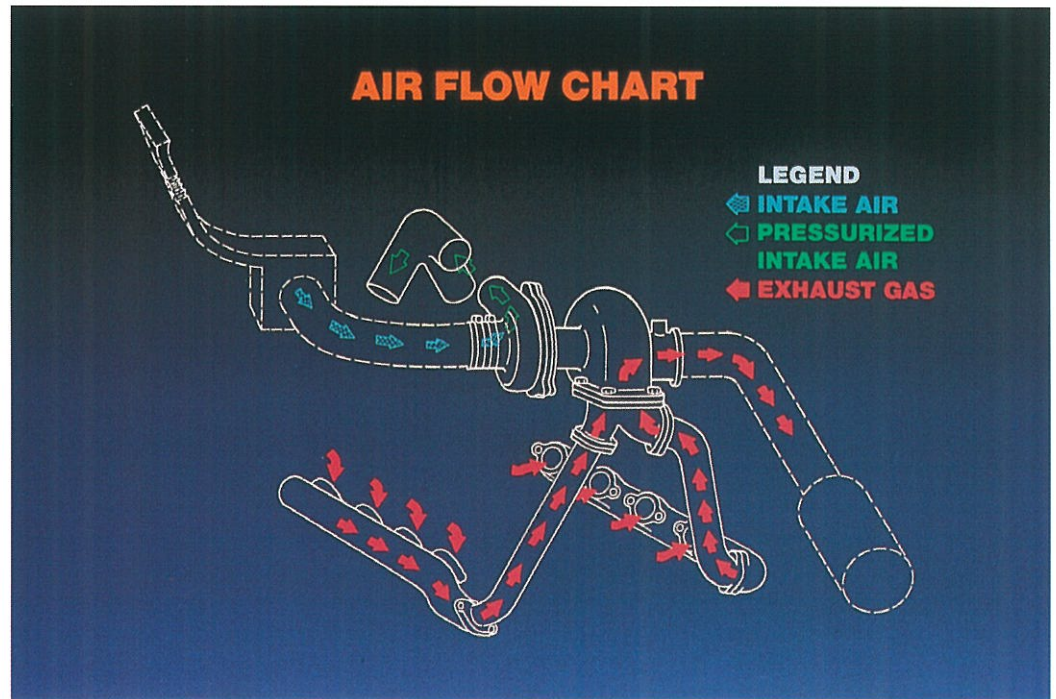

50

AIR FLOW CHART FOR INTAKE AND EXHAUST SYSTEM

- The intake and exhaust systems consist of those components that flow filtered air to the engine cylinders and exhaust gases to the atmosphere.
- The turbocharger is used to increase engine performance output by increasing air supply to the engine. It is a simply designed oil-cooled exhaust-driven compressor that allows filtered air to enter the compressor housing and is forced under pressure to the combustion chamber. After combustion, hot and expanding exhaust gases move through the turbine housing causing the turbine wheel to spin. The turbine wheel drives the compressor wheel through a common single shaft.
- The turbocharger responds directly to the engine loads. During heavy load, increased flow of exhaust gases and heat turns the turbine wheel faster causing the compressor impeller to turn faster and supply more air (greater boost) to the intake manifold. Conversely, with light engine load, flow of exhaust gases decrease and less air is pumped into the intake manifold.

COOLING SYSTEM

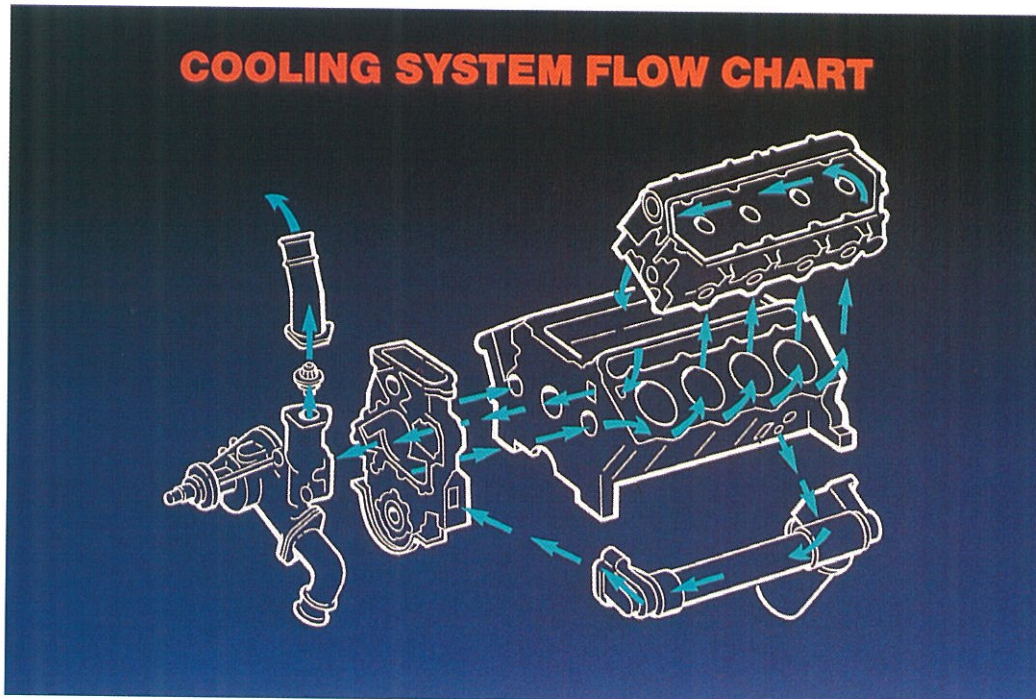

51

COOLING SYSTEM FLOW CHART

- Coolant flows from the radiator to the water pump, through the front cover to the crankcase, cylinder head, oil cooler and on to the engine thermostat.
- When the thermostat is closed, coolant flows through a bypass back to the water pump without going through the radiator. This provides for rapid engine warm-up. When the coolant reaches 205° F (96.1°C) the thermostat starts to open and the coolant begins to flow to the radiator. The thermostat is fully open at 230° F (110°C).

GLOW PLUG SYSTEM

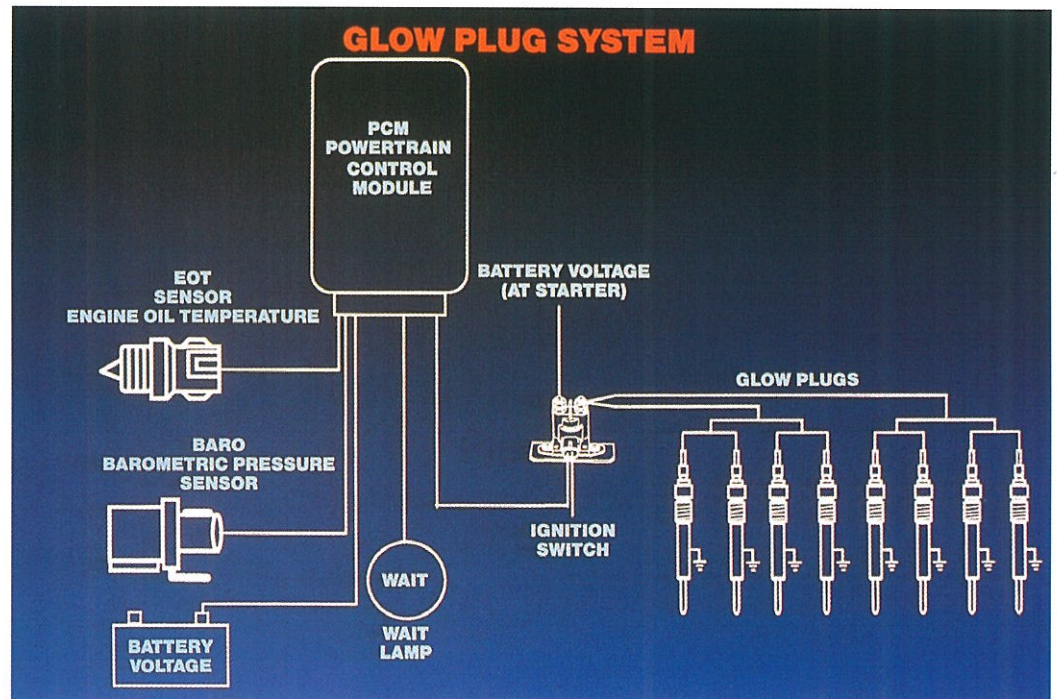

52

GLOW PLUG SYSTEM

- The purpose of the glow plug system is to warm-up the engine cylinders to improve/enhance cold engine starting.
- The Powertrain Control Module (PCM) is programmed to turn the "WAIT" to start light on and energize the glow plugs (via the glow plug relay) each time the ignition switch is placed in the "ON" position prior to starting an engine.
- The PCM monitors battery voltage and uses information from the engine oil temperature (EOT) and barometric (BARO) sensors to determine the amount of "Wait to Start" light, and glow plug activation time.
- The glow plugs are self limiting, eliminating the need for a controller.
- Inside the plugs are 2 coils (resistance) connected in series. One to create heat and one to control heat at its peak.

ENGINE FEATURES

TABLE OF CONTENTS

ENGINE FEATURES	49
FRONT & LEFT SIDE OF ENGINE.....	50
REAR OF ENGINE.....	51
RIGHT SIDE OF ENGINE	52
TOP OF ENGINE	53-54
CRANKCASE TOP	54
CRANKCASE.....	55
CRANKSHAFT.....	55
CAMSHAFT	55
FRONT GEAR TRAIN	56
CONNECTING ROD.....	56
PISTON.....	56
TAPPETS/LIFTERS.....	57
CYLINDER HEAD (DECK).....	57
CYLINDER HEAD.....	58-60
FRONT COVER.....	60
WATER PUMP.....	61
OIL PUMP.....	61
VIBRATION DAMPER	62
REAR SEAL.....	62
OIL PICKUP TUBE	63
OIL PAN.....	63
OIL COOLER.....	63
EXHAUST MANIFOLD	64
HIGH PRESSURE PUMP.....	64
HIGH PRESSURE PUMP DRIVE.....	64
RESERVOIR.....	65
THERMOSTAT	65
IPR VALVE	65
HIGH PRESSURE HOSE.....	66
TRANSFER PUMP	66
FUEL FILTER	67
FUEL RETURN HOSES.....	67
TURBOCHARGER	67
CRANKCASE BREATHER.....	68
TURBOCHARGER	68
DIPSTICK	68

ENGINE FEATURES

FRONT OF ENGINE

- The **CMP sensor** mounts through the front cover, is attached by a single bolt, and is sealed by an "O"-ring. The sensor's installed depth (clearance) is established by its body and is not adjustable.
- The **oil reservoir** stores approximately one quart of engine oil, used to actuate the injectors, at its position above the timing gears. Mounted to the reservoir are the EOP sender and EOT sensor.

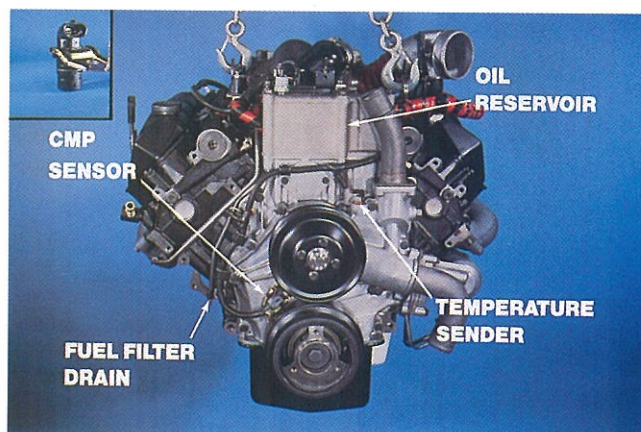

53

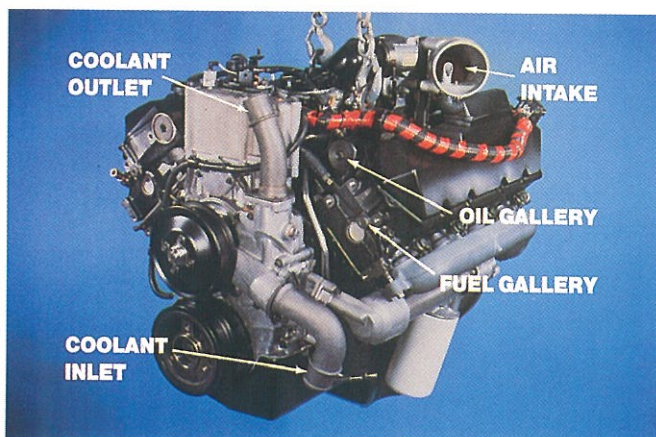

54

LEFT FRONT OF ENGINE

- **Threaded Plugs** and "O"-rings seal the oil and fuel galleries at the ends of each cylinder head and may be removed during major engine service to facilitate cleaning.

LEFT SIDE OF ENGINE

- Crankcase vapors are routed into the intake system from the **breather**, attached to the left valve cover.
- The remote mounted air cleaner connects to the engine's intake system.
- A **peto tube** is mounted in the intake air stream to contribute to crankcase pressure regulation.
- Filtered air maximum restriction remains 25" H₂O.
- The vehicle electronic system is connected to the engine through a **single forty-two (42) pin connector**.

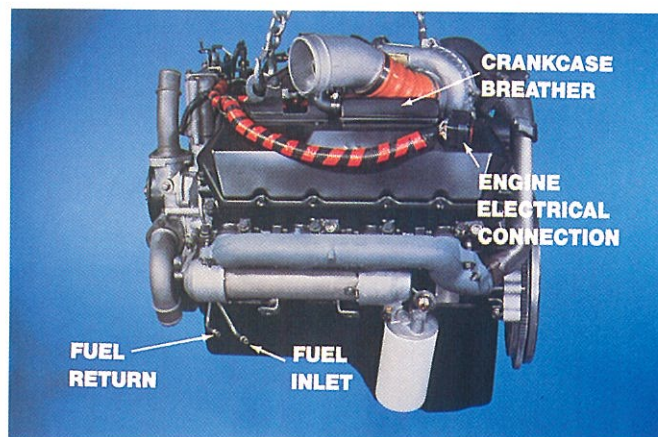

55

ENGINE FEATURES

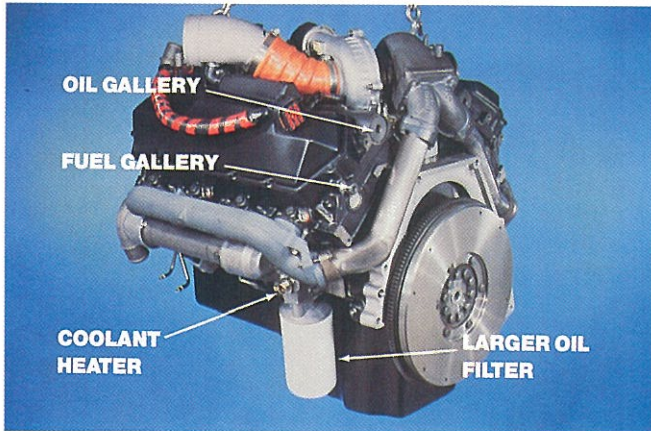

56

REAR OF ENGINE

- The engine features an aluminum **transmission adapter**.
- The **exhaust manifolds** are connected to the turbine housing by formed steel pipes and a **cast collector** which is tuned to dampen exhaust pulsations prior to driving the turbine wheel.

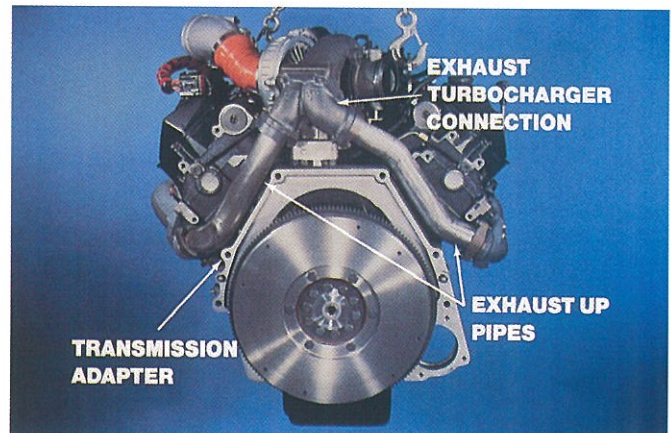

57

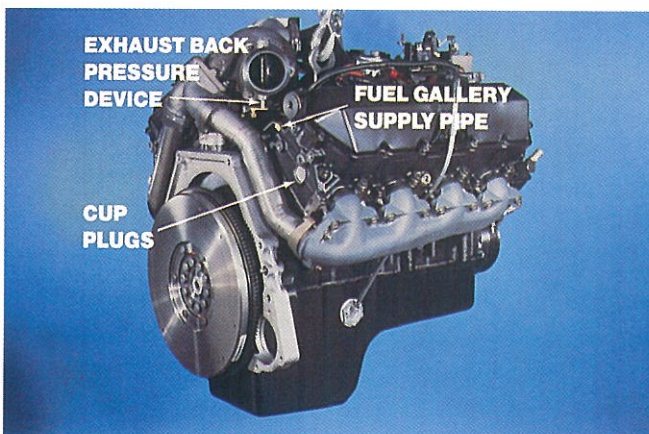

58

LEFT REAR OF ENGINE

- The large "**Extender**" oil filter uses micro-glass filter media.
- Lab tests confirm that micro-glass filters are 3 to 4 times better than previous filters.
- The **engine coolant heater** is threaded into the rear oil cooler header and operates on 110 volts/AC to assist cold starts.

RIGHT REAR OF ENGINE

- The **exhaust back-pressure device** will provide faster engine warm up in cold ambient temperatures by restricting exhaust and increasing engine load during warm up only.
- The EBP device is a hydraulically activated, electronically controlled servo in the base of the turbocharger.
- To enhance serviceability, **cup plugs** are used throughout the engine in core clean out holes.
- Fuel from the piston stage of the fuel pump enters the heads at the rear of the engine.

ENGINE FEATURES

RIGHT SIDE OF ENGINE

- The **oil fill cap** is at the front of the right valve cover.
- The **oil level dipstick** is mounted through the oil pan for easier dipstick removal and installation.
- The dipstick is calibrated to indicate 2 quarts between add and full.

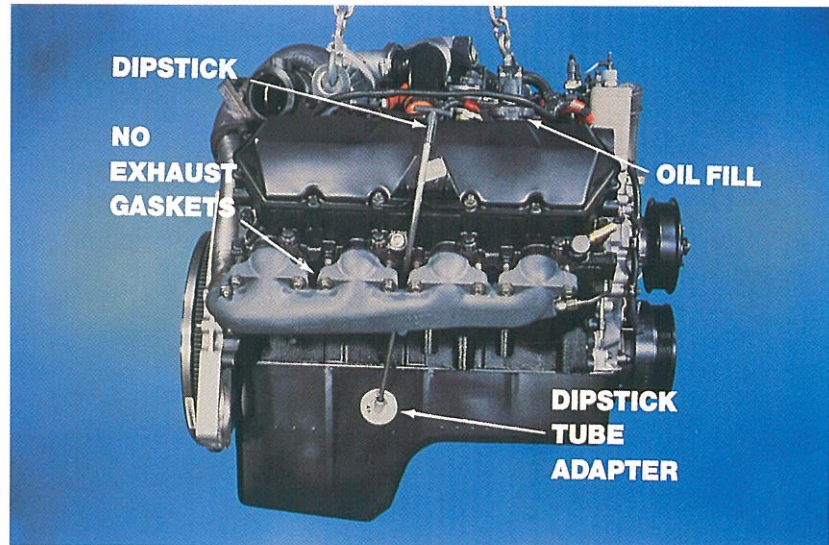

59

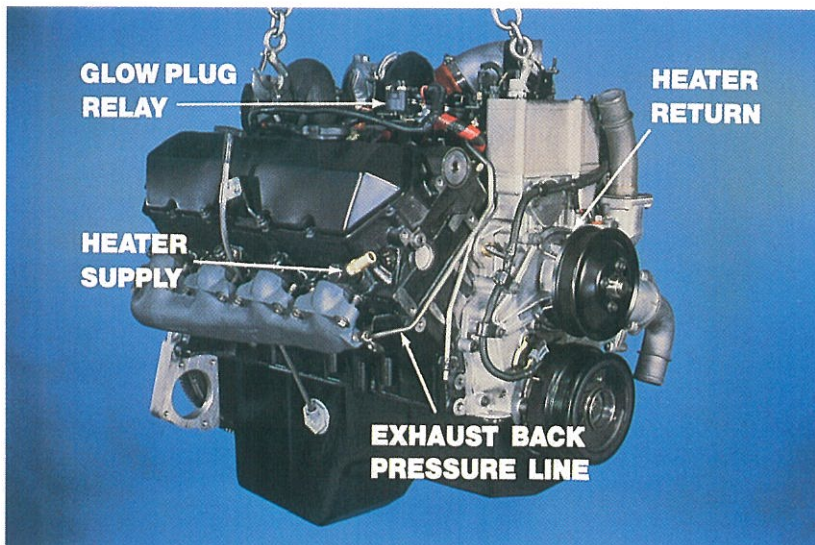

60

RIGHT SIDE FRONT OF ENGINE

- The PCM (Powertrain Control Module) controls the glow plugs through an engine mounted relay. The **glow plug relay** supplies 12 volts to the self limiting glow plugs, located under the valve cover.
- A steel line connects the **back-pressure sensor** to the right exhaust manifold. In cold ambient temperatures, the PCM uses back-pressure sensor information to determine back-pressure device butterfly position which enhances the warm-up characteristics of the engine.

ENGINE FEATURES

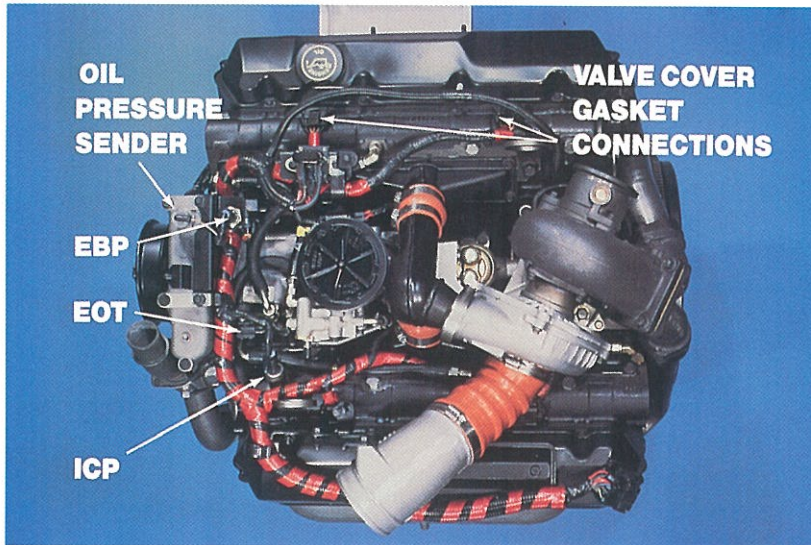

61

TOP OF ENGINE (ELECTRICAL)

- Both the ICP (Injection Control Pressure) and IPR valve (Injection Pressure Regulator) are used by the PCM to monitor and control the high pressure oil system.
- EOT (Engine Oil Temperature) sensing is used by the PCM to make timing and fuel rate adjustments based on engine temperature.
- EBP (Exhaust Back-Pressure) sensor monitors exhaust restriction during the operation of the exhaust back-pressure control system in cold ambient temperatures.
- Connections for the glow plugs and injectors are accomplished through the valve cover gasket. Electrical connections are made both inside and outside of the re-usable valve cover gasket.

TOP OF ENGINE (MECHANICAL)

- The low pressure fuel system supplies fuel to the injectors at 40 psi pressure.
- High pressure oil, delivered by special lines to galleries in the heads, is used to generate 21,000 psi fuel injection pressure in the HEUI injectors.

IMPORTANT HIGH PRESSURE HOSES

- The hoses are made specially to withstand the pressure and temperature of this system. Use only FORD certified replacement hoses.
- Formed steel intake manifolds direct turbocharged air to each cylinder

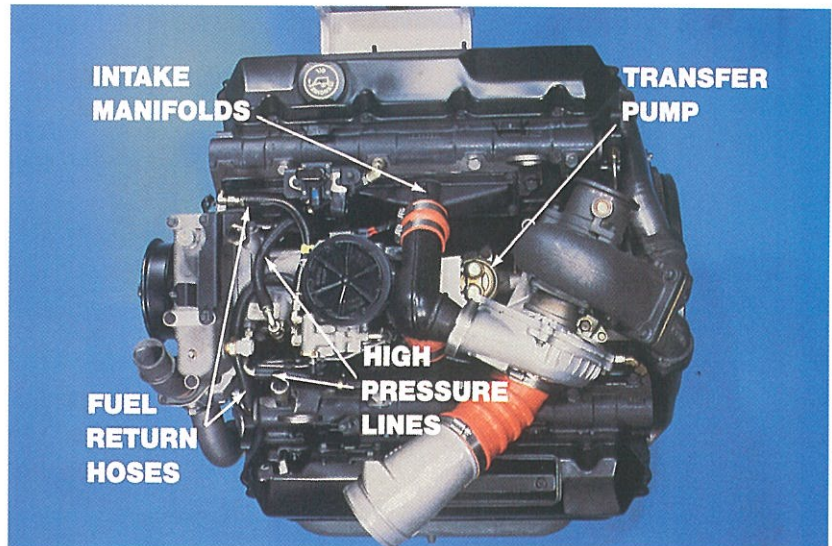

62

ENGINE FEATURES

TOP OF ENGINE

- The **engine lifting eyes** are bolted to the cylinder heads.
- The **fuel filter** is mounted low in the center of the engine and is equipped with a manual water drain, fuel heater, restriction sensor, and WIF sensor.
- The fuel filter will be accessed through a hinged panel in the engine cover.
- The oil used to create injection pressure is charged by a **gear driven pump** bolted to the front cover.

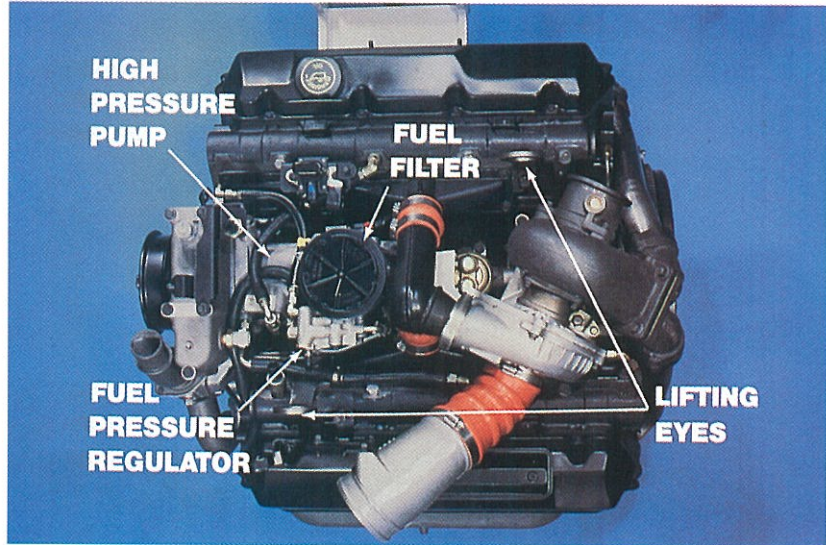

63

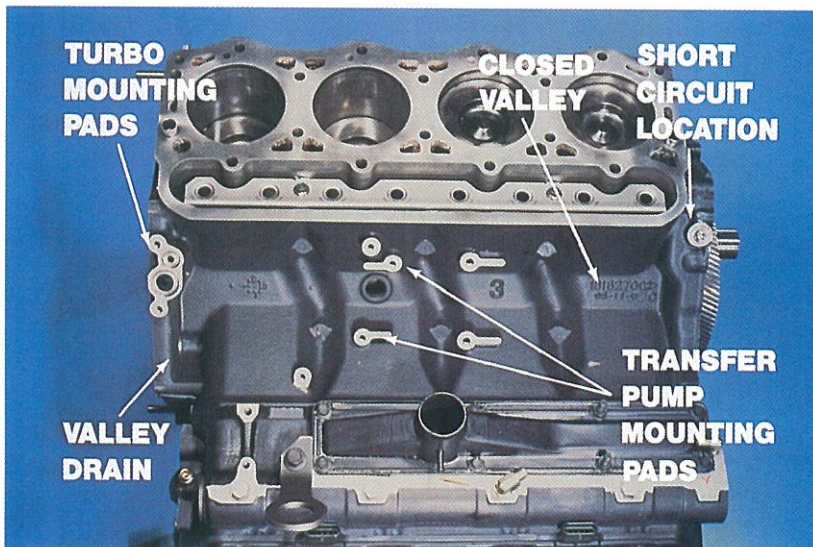

64

CRANKCASE - TOP

- The potential for oil leakage has been reduced through the design of a **closed crankcase valley**.
- The base of the turbocharger bolts directly to the crankcase. The turbochargers **oil supply** and **drain passages** are integral to the base and the passages are sealed by "O"-rings at the crankcase, eliminating external feed and drain lines.
- The **fuel transfer pump** mounts in the valley and is driven by a dedicated lobe on the camshaft.
- A **short circuit** exists in the oil feed to the high pressure lube system. This short circuit keeps the reservoir full at start up until oil pressure is attained.

ENGINE FEATURES



65

CRANKSHAFT

- The oil pump's inner **gerotor** is driven by the front of the crankshaft. This high efficiency pump provides higher pressures and volumes.
- The **flywheel bolts** thread into **blind holes** in the crankshaft, eliminating the need for sealant on the bolts.
- The width of each **main bearing** has been increased 7% to improve service life. The 7.3 DIT continues to use crankshafts with hardened journals and fillets on the main and rods.
- The crankshaft utilizes 5 main bearings.

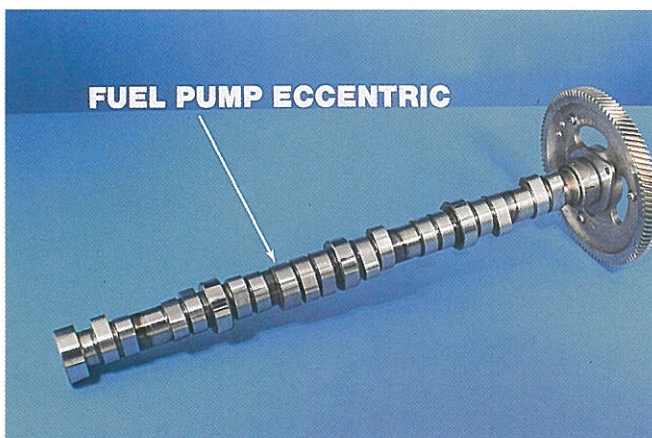

67

CRANKCASE

- This short circuit **oil gallery** is connected directly to the gerotor pump discharge. This provides a quick fill of the high pressure pump reservoir for fast cold starting.
- The ball check unseats momentarily during cold cranking until engine oil pressure is equalized on both sides of the ball check. When the ball seats it prevents unfiltered oil from entering the reservoir during engine operation.

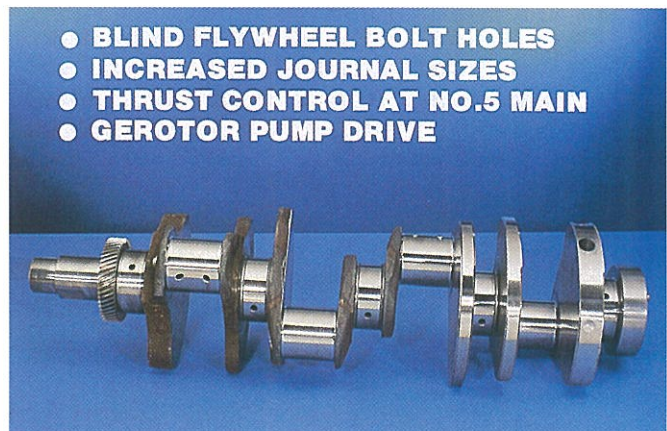

66

CAMSHAFT

- The **fuel pump eccentric** is machined as part of the camshaft and is located between the third and fourth bearing journals.
- The camshaft is supported by 5 cam bearings. The camshaft is forged steel with induction hardened lobes.

ENGINE FEATURES

FRONT GEAR TRAIN

- The **camshaft** is timed to the crankshaft by aligning the dot on each gear. Timing of the high pressure oil pump drive gear is NOT required.
- The **timing disk** is pressed into and bolted to the front face of the camshaft gear. Windows on the timing disk are sensed by a hall effect CMP (CAM Position) sensor to determine engine speed. One narrow "window" and an opposing wide "window" provide sync pulses to the CMP sensor to indicate camshaft position for correct cylinder timing. The timing disk and gear are serviced as an assembly.



68

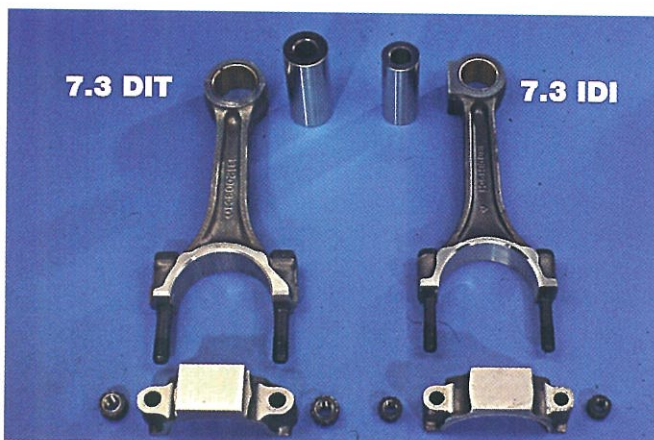

69

CONNECTING ROD

- The **connecting rod bearing** width has been increased 9% for improved bearing and journal life.

PISTON

- The engine utilizes **direct injection**. Fuel is injected into the combustion chamber at the top of the piston. The swirl needed for combustion is created by the "Mexican Hat" design of the piston.
- Under head of the piston utilizes a **Tee-Pee design** pin bore to allow maximum load distribution during combustion and the power stroke.
- The DIT piston incorporates durable Ni resist top ring inserts and a plasma coated top ring.
- The underhead of the piston is cooled by a stream of oil from the piston cooling nozzle.

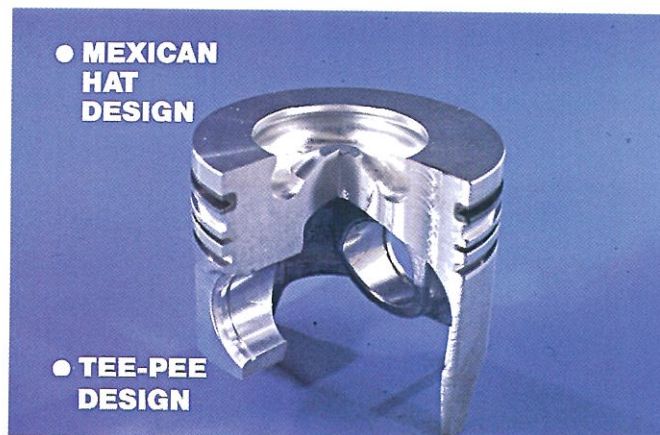

70

ENGINE FEATURES

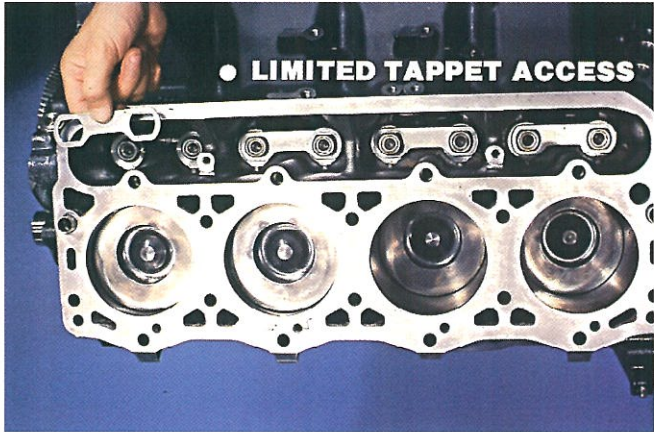

71

TAPPETS/LIFTERS

- The **tappet retainers** hold the push rods in place and have holes in them to guide the push rods into the tappets.
- Due to the **increased clamp load**, the graphite head gaskets do not require grommets.
- The **clamp load** on the cylinder head has been increased. There are now six (6) metric headbolts around each cylinder bore as opposed to the previous 7.3's five per bore.

TAPPETS/LIFTERS

- The engine's **closed valley** requires cylinder head removal to gain access to the cam tappets.
- The **tappet guides** completely encircle the tappets to ensure proper orientation to the camshaft lobe.
- Cylinder **head gasket clamp load** has been increased through the use of 6 head bolts per cylinder.

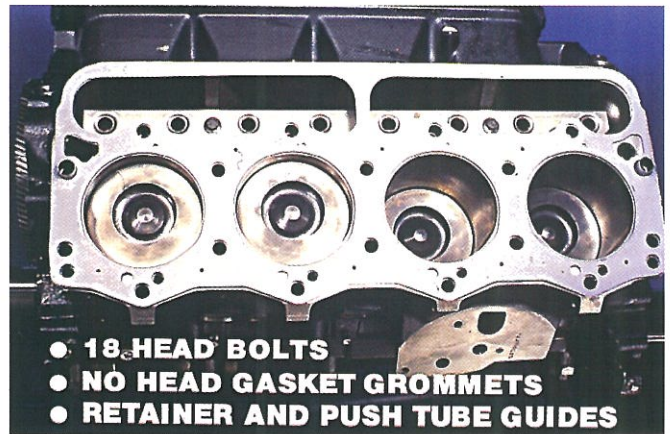

72

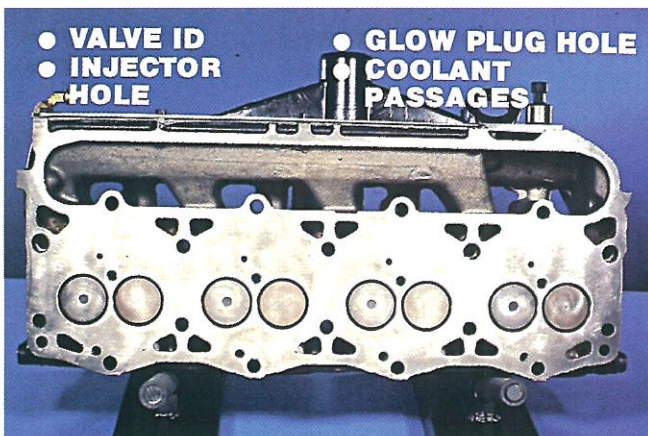

73

CYLINDER HEAD (DECK)

- Changes in the cylinder head due to direct injection include:
 - Elimination of pre-chambers
 - Due to the combustion chamber in the piston, injectors protrude through surface of head deck
 - Glow plugs protruding through the head
 - Injectors and glow plugs can have tips damaged if they are in removed cylinder heads.
 - The intake valves are identified by a dimple in the center of the head. **Intake and exhaust valves are not interchangeable.**
- As with previous 7.3's, the cylinder heads on the 7.3 DIT's cannot be resurfaced.

ENGINE FEATURES

CYLINDER HEAD

- The **positive valve stem seals** are of a new design. They are secured by the valve spring and cover the guide.
- **Valve rotators**, mounted at the top of the valve spring, are used to extend valve life.
- The self-limiting temperature **glow plugs** are located under the valve cover.
- To accommodate injector removal, **oil drain plugs** located under the valve covers are used to drain the high pressure oil galleries.



74

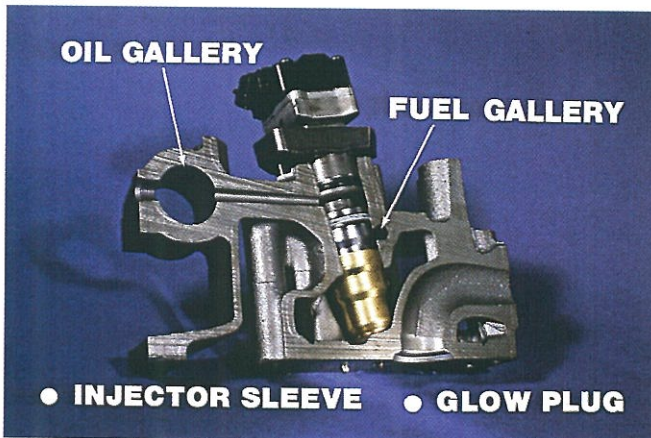

75

CYLINDER HEAD NOZZLE HOLE

- The **fuel gallery** is charged from the rear of each head and the rail intersects each injector bore.
- Each injector is connected to the **oil gallery** by a drilled passage.
- The injector's intersections with the fuel and oil galleries are sealed by "O"-rings.
- The injectors are installed in brass sleeves in the heads. Coolant flows around the outside of the sleeve to cool the injectors. When servicing sleeves, they must be sealed with LOCTITE® No. 609 sealant.

CYLINDER HEAD

- **Fuel galleries** in the cylinder heads are sealed at both ends by plugs using "O"-rings.
- The oil galleries in the cylinder head are sealed by plugs using "O"-rings and back up rings. The oil plugs are also sealed with LOCTITE® No. 609 sealant on the threads.

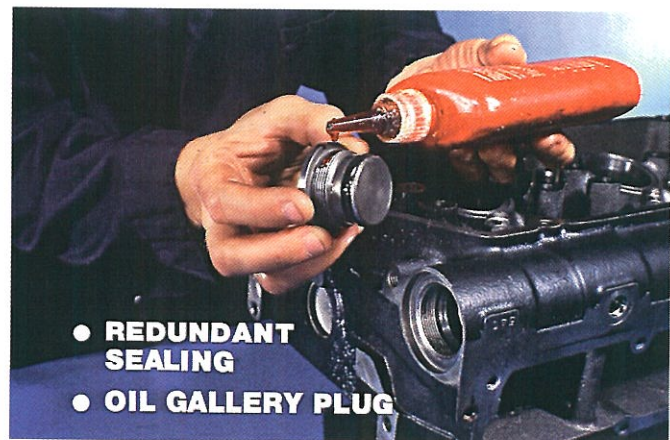

76

ENGINE FEATURES



77

CYLINDER HEAD

- **Rocker arms** are mounted on pedestals and pivot on steel balls. A spring steel clip holds the assembly together. The rocker arm assembly can be assembled for either an intake or exhaust using the same parts by changing orientation of the components.
- The position of the rocker arms should be identified and reinstalled in the same position to avoid abnormal wear.
- **Push rods** continue to have a copper colored upper tip.



79

CYLINDER HEAD

- The **inboard injector hold down bolts** (toward the valley) must be installed prior to injector installation.
- The **injector fuel and oil passages** are separated and sealed by "O"-rings.
- The fuel section of the injector is below the oil section.
- The **copper gasket** at the bottom seals the injector to the combustion chamber.
- The **injector "O"-rings and gaskets** must be replaced each time the injector is removed.

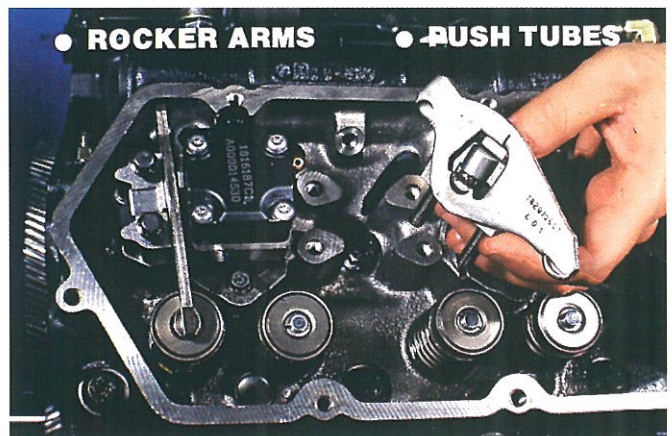

78

CYLINDER HEAD

- The reusable **valve cover gasket** has electrical conductors molded into it. The gasket is made with a silicone bead on each side to conform to surfaces and provide the seal. Two harnesses under the valve cover provide the connections to the glow plugs and injectors.

ENGINE FEATURES

CYLINDER HEAD

- The **valve cover gaskets** are marked "reusable."
- Oil used to actuate the injectors is discharged following the fuel injection event through spill spouts.
- The **UVC** (Under Valve Cover Harness) connects to two glow plugs and two injectors. The center wire on the UVC is a common voltage supply for two injectors.
- Each cylinder head requires two UVC harnesses (four injectors, four glow plugs).

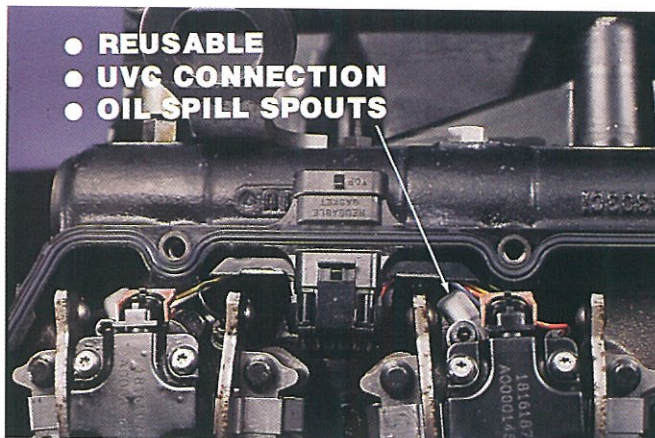

80

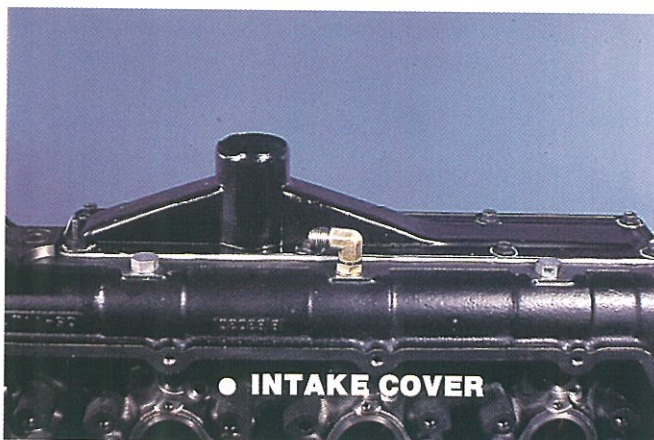

81

CYLINDER HEAD

- The lightweight **intake covers** are stamped steel and are bolted to the cylinder heads. The manifolds are sealed with Wacker® T-95 RTV sealant.

FRONT COVER

- The areas of the front cover which intersect with engine coolant and positive oil supply pressure are sealed with formed "O"-rings, in formed grooves.
- Areas of the front cover which are exposed to engine oil splash are sealed by Wacker® T-95 RTV sealant.
- The front cover is aligned to the crankcase with **dowel pins**.
- The CMP (Camshaft Position) sensor is mounted in the front cover.
- The lube oil pickup tube bolts directly to the front cover and is sealed to the front cover with a formed "O"-ring, resting in a groove.

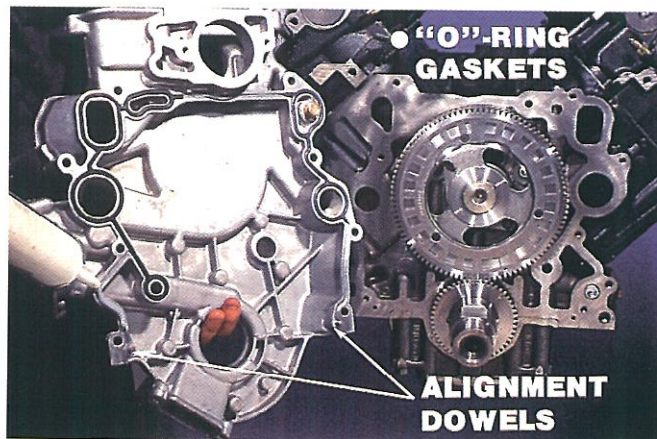

82

ENGINE FEATURES



83

OIL PUMP

- On the nose of the crankshaft there are two flats used to drive the **gerotor oil pump's** inner rotor. The inner rotor has fourteen teeth and the outer rotor has fifteen spaces. As the pump rotates and the rotors separate, oil is drawn into the pump then continued rotation causes the rotors to mesh on the opposite side of the pump. When the rotors mesh, the area inside the pump decreases and oil is forced into the oil cooler.
- The **oil pump housing** is located by dowel pins in the front cover for proper alignment and is sealed by an "O"-ring in a groove.

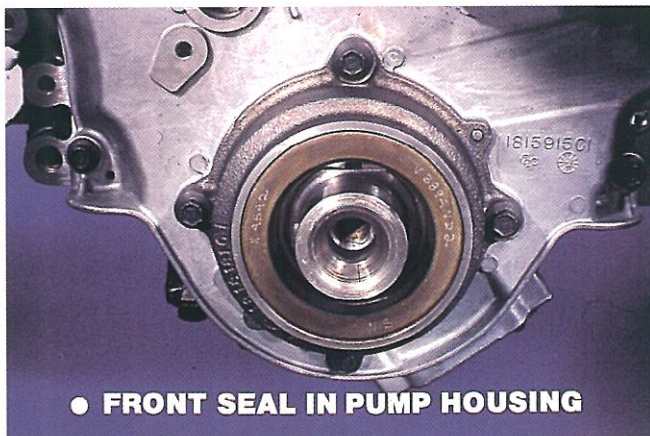

85

WATER PUMP

- The die cast **water pump housing** contains the heater return port.
- The water pump's direction of rotation is counter clockwise, opposite of the water pump on previous 7.3 engines.

IMPORTANT

The fan clutch threads onto the water pump hub using right hand threads.

- The engine's **thermostat housing** is integral with the water pump.



84

OIL PUMP

- The crankshaft front seal is located in the oil pump housing. The seal may be replaced by removing the vibration damper. Removal of the oil pump housing is not required for seal replacement.

ENGINE FEATURES

VIBRATION DAMPER

- The **vibration damper** will have a replaceable wear sleeve on its sealing surface.
- The vibration damper is located on the crankshaft with a keyway.



86

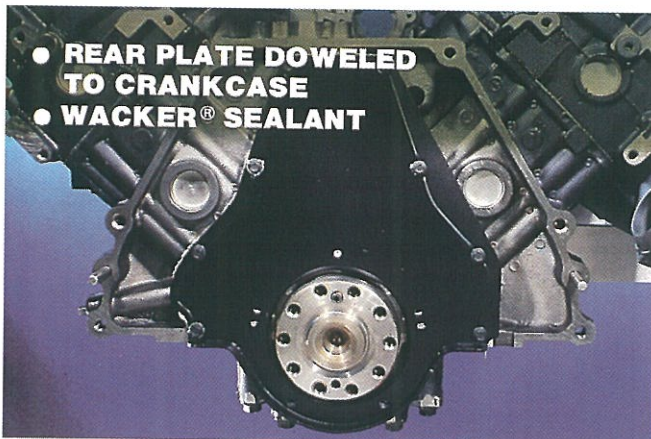

87

REAR PLATE

- The **rear seal plate** is aligned to the crankcase with dowel pins and sealed to the crankcase with Wacker® T-95 RTV sealant.
- The **flywheel** is located on the crankshaft by a dowel pin to insure proper position for balance.

REAR SEAL

- The **rear seal** is molded into a bolt on carrier simplifying rear seal replacement.
- Five bolts secure the **rear seal carrier**.

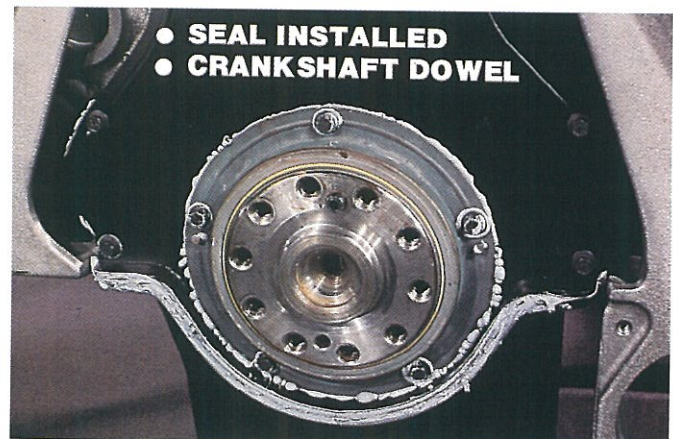

88

ENGINE FEATURES



89

OIL PAN

- The **oil pan** is secured by 12 bolts and is sealed with Wacker® T-95 RTV sealant.
- A **windage tray** is used to minimize oil aeration within the crankcase.
- The **dipstick mount** is sealed with a replaceable "O"-ring.

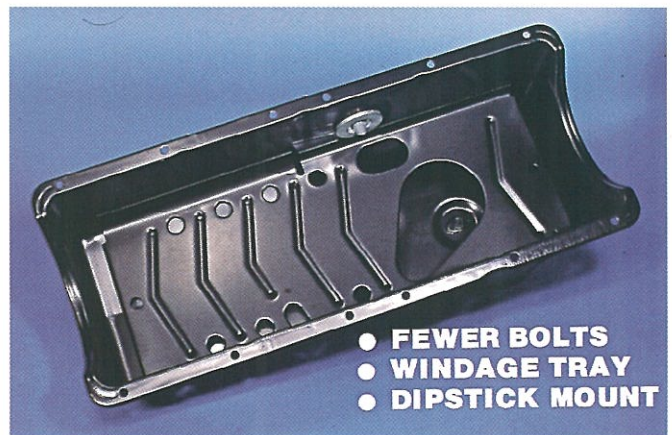

90

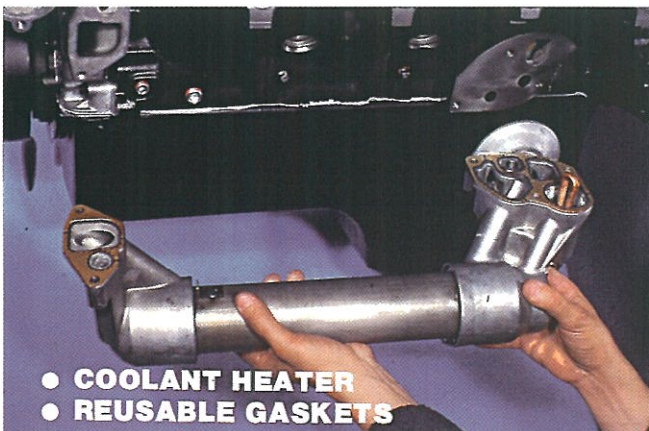

91

OIL PICK UP TUBE

- The **oil pump pick up tube** is bolted directly to the engine's front cover and is sealed by an "O"-ring. The pick up tube is also secured by a bracket fastened to a main bearing cap.

OIL COOLER

- The **oil cooler** assembly is sealed to the front cover and the crankcase with reusable gaskets.
- The **coolant heater** is threaded into the rear header of the oil cooler.

ENGINE FEATURES

EXHAUST MANIFOLD

- The nodular iron **exhaust manifolds** will not be sealed by gaskets in production. Exhaust gaskets will be available for service.
- To ease manifold installation, one manifold bolt hole is smaller in diameter to accurately position the manifold. This bolt should be installed first.

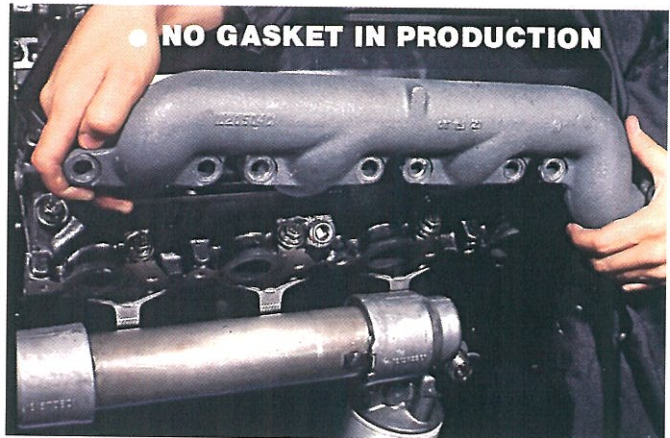

92



93

HIGH PRESSURE PUMP

- The **high pressure oil pump** is sealed to the front cover with a reusable gasket.
- The high pressure oil pump drive gear is not timed to the camshaft or to the pump.
- The gear is attached to the pump's shaft by a bolt requiring proper torque.

HIGH PRESSURE PUMP DRIVE

- The **reservoir** which supplies oil to the high pressure pump is filled by a passage in the engine's front cover.
- The reservoir tower, sealed by an "O"-ring on the pressure side and Wacker® T-95 RTV sealant on the splash side, holds a constant supply of engine oil for the high pressure pump.
- The bolt securing the high pressure pump drive gear must be accessed by removing a plate on the front cover.



94

ENGINE FEATURES

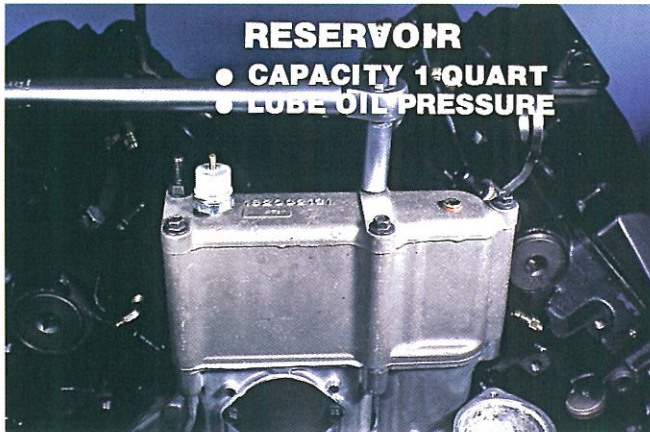

95

THERMOSTAT

- The **bypass** in the cooling system is incorporated into the water pump housing as the thermostat opens, the "hat" moves downward and seals the bypass closed, directing all coolant to the radiator.
- The thermostat incorporates a ball check type deaeration feature that facilitates engine coolant fill.

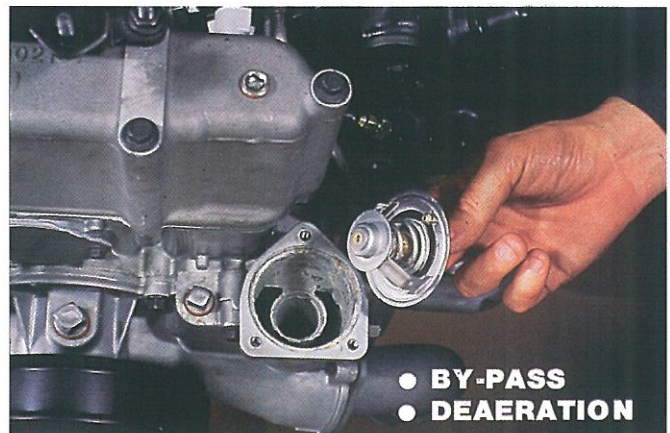

96

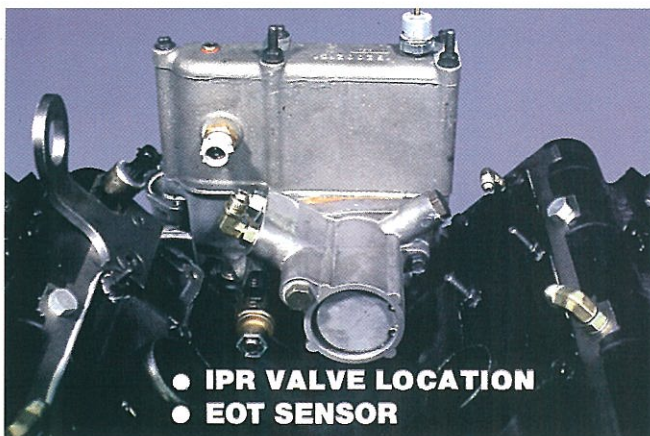

97

IPR VALVE

- The **IPR valve** (Injection Pressure Regulator) is controlled by the PCM to vary the oil pressure used to actuate the injectors.

ENGINE FEATURES

HIGH PRESSURE HOSE

- Hoses which have been specifically designed to withstand the high pressures and temperature differentials are used to direct the high pressure oil to the oil galleries in the heads.

IMPORTANT

Use only FORD certified replacement hoses for this application.

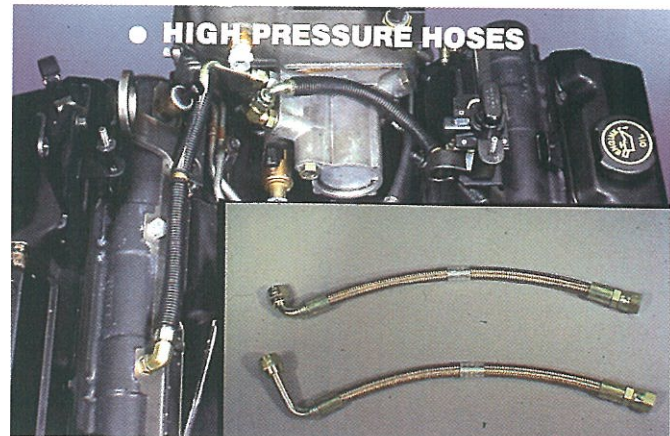

98

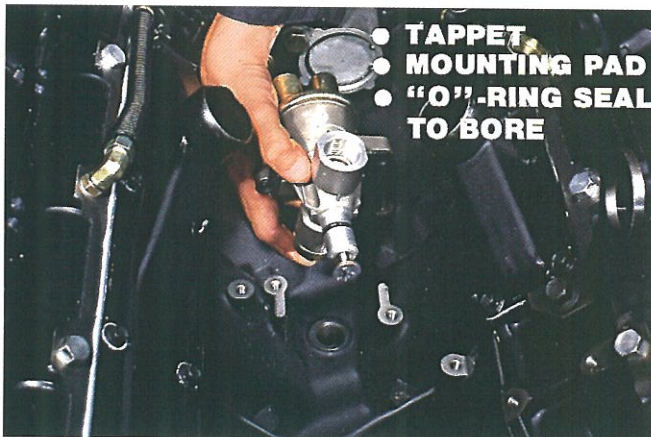

99

TRANSFER PUMP

- The **fuel transfer pump** has two stages. The low pressure diaphragm stage lifts fuel from the tank and pumps it to the fuel filter. The high pressure stage raises fuel pressure to 40 to 70 psi in the cylinder head fuel galleries.
- The transfer pump mounts in the crankcase valley and is operated by a lobe of the camshaft using its own tappet.

TRANSFER PUMP

- The fuel is directed into the rear of each cylinder head **fuel gallery**.
- The **banjo fitting** is sealed by coated aluminum gaskets on both sides. Steel lines are used to deliver the fuel.

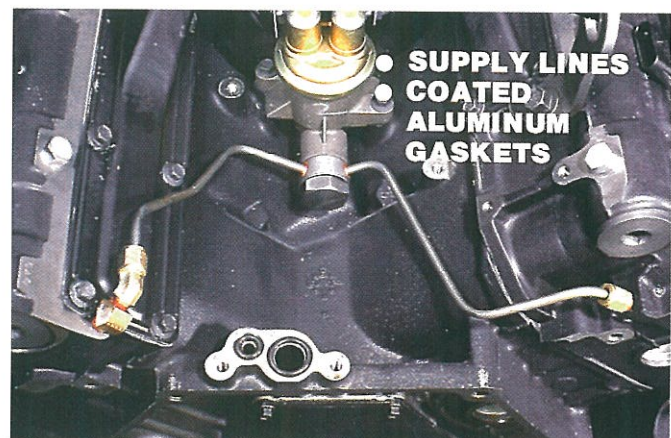

100

ENGINE FEATURES

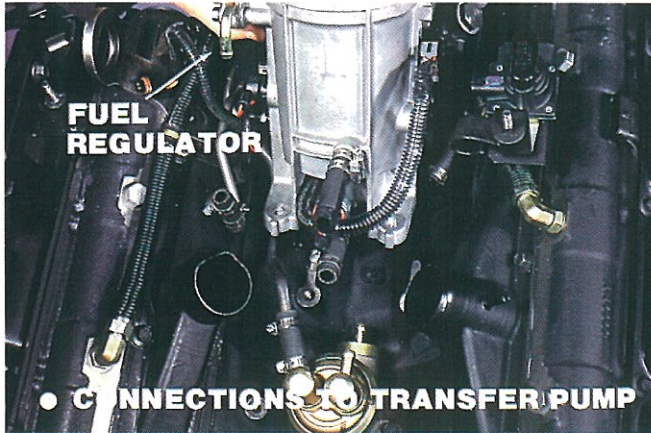

101

FUEL RETURN HOSES

- Use only certified replacement hoses of the correct part number when repairing the 7.3 DIT fuel system. Substituted hoses may not meet pressure and, or flexibility requirements needed for proper fuel system operation.

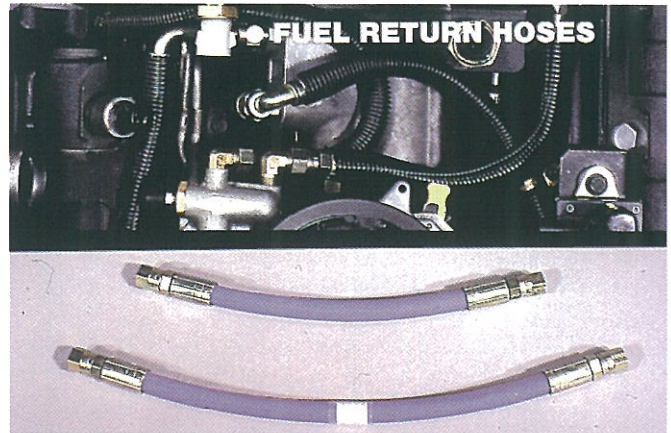

102

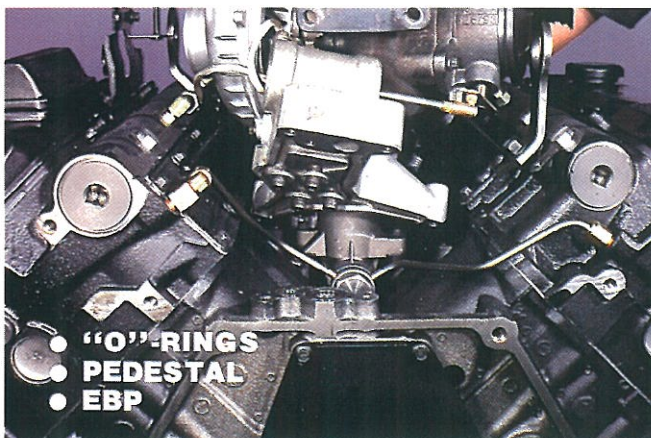

103

FUEL FILTER

- The ports at the top of the transfer pump are the low pressure inlet (left) and outlet (right). Outlet pressure (5-10 psi) is directed to the fuel filter. Filtered fuel is directed back to the transfer pump where its pressure is raised for delivery to the fuel galleries in the heads.
- **Return fuel** from the fuel galleries in the heads is directed to the pressure regulator on the filter housing. This pressure regulator also controls the quantity of fuel returned to the tank.

TURBOCHARGER

- The **turbocharger mounting pedestal** bolts directly to the crankcase and its internal passages for turbocharger lube and drain are sealed by "O"-rings. The pedestal may be removed from the turbocharger.
- Contained in the pedestal are the EBP (Exhaust Back-Pressure) regulator solenoid and the EBP piston. Oil regulated by the EBP solenoid actuates a piston which in turn operates the back-pressure control valve.

ENGINE FEATURES

CRANKCASE BREATHER

- The closed **crankcase breather** allows crankcase vapors to be drawn into the air intake system by intake air flow. The breather filter keeps oil from migrating into the intake system. The crankcase breather is sealed to the valve cover by "O"-rings.

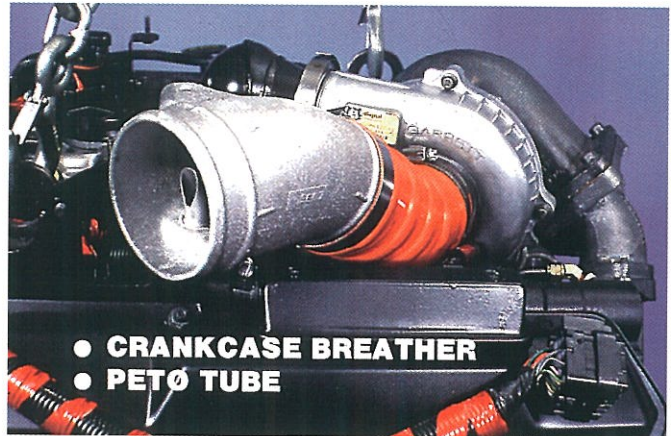

104

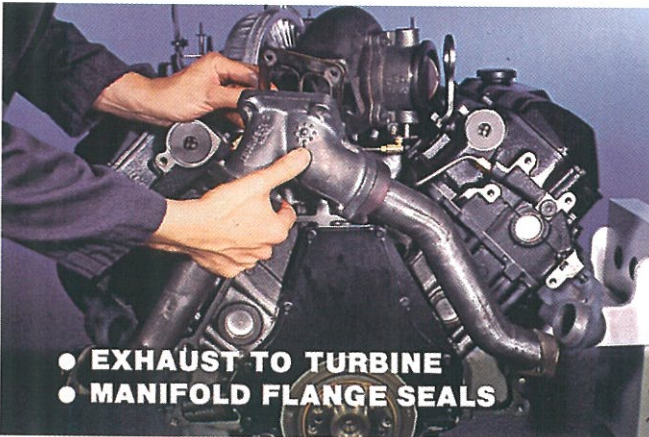

105

TURBOCHARGER

- Exhaust gases are directed from the exhaust manifolds to the turbocharger through stainless **steel exhaust pipes**. The pipes are connected to the turbine collector which is designed to dampen exhaust pulsations prior to the turbine wheel.

DIPSTICK

- The **dipstick tube** is bracketed to the valve cover bolts and goes through a mount on the oil pan. The mount in the oil pan is sealed by "O"-rings to the pan and to the tube.

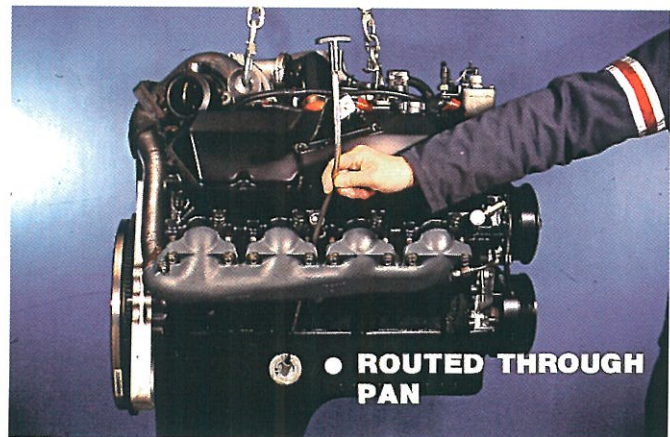

106

UNIQUE SERVICE PROCEDURES

TABLE OF CONTENTS

UNIQUE SERVICE PROCEDURES	69
SHORT CIRCUIT (OIL BYPASS)	70
CRANKCASE	70-71
CYLINDER HEAD	72
HIGH PRESSURE PUMP	73
INJECTOR REMOVAL	73-75
INJECTOR	76
CYLINDER HEAD SLEEVE	77
CYLINDER HEAD	77-79
INTAKE & EXHAUST VALVES	80
VALVE STEM SEALS & ROTATORS	80
VALVE RECESSION	80
CYLINDER HEAD	81
INJECTOR INSTALLATION	82-84
ROCKER ARM ASSEMBLY	84
HIGH PRESSURE PUMP	85
HIGH PRESSURE RESERVOIR	85
HIGH PRESSURE PUMP	86-89
INSTALLING IPR	89
INSTALLING IPR SOLENOID	90
HIGH PRESSURE HOSES	90
FUEL FILTER REMOVAL	90-91
TRANSFER PUMP	91
TRANSFER PUMP INSTALLATION	92
TURBOCHARGER	93-94
TURBOCHARGER INSPECTION	95
TURBOCHARGER PEDESTAL INSPECTION	96
TURBOCHARGER PEDESTAL REASSEMBLY	97
EBP ASSEMBLY	98
TURBOCHARGER INSTALLATION	98
FRONT SEAL/OIL PUMP	99-104
REAR SEAL	104-107
OIL PAN	108
WATER PUMP & FRONT COVER	108-110
OIL PAN	110

UNIQUE SERVICE PROCEDURES

- The purpose of this section is not to replace the service manual, but rather to highlight unique service procedures. The service manual is designed to be all inclusive.

SHORT CIRCUIT (OIL BYPASS)

- Inspect the ball and seat for erosion. Cleaning with a nylon brush will ensure cleanliness during engine rebuild.

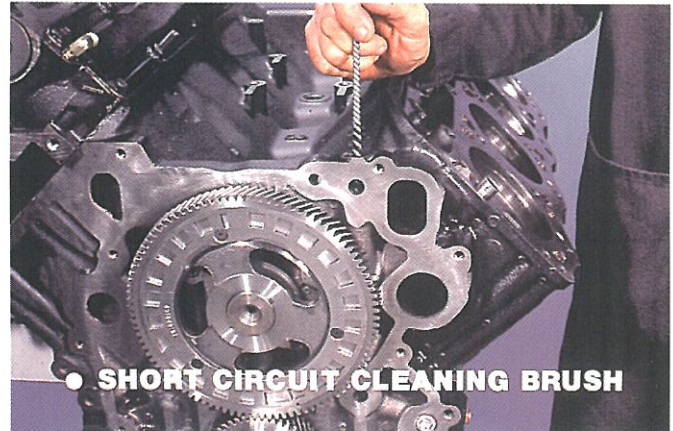

107



108

CRANKCASE

- Cup plugs are used to seal the crankcase core clean out holes. This style of plug makes for easier removal and installation.
- Sealant should be used on the outer edge of the cup plug to ensure sealing.
- The installing tool, #OTC ZTSE-4309, will position the plug to the proper depth in the crankcase.

CRANKCASE

- The closed valley of the crankcase requires the cylinder head to be removed to access the valve lifters. The retainer and openings in the cylinder head will not allow lifter removal.
- The retainer holds the guide plates in place and is used to guide the push rods into the valve lifters.

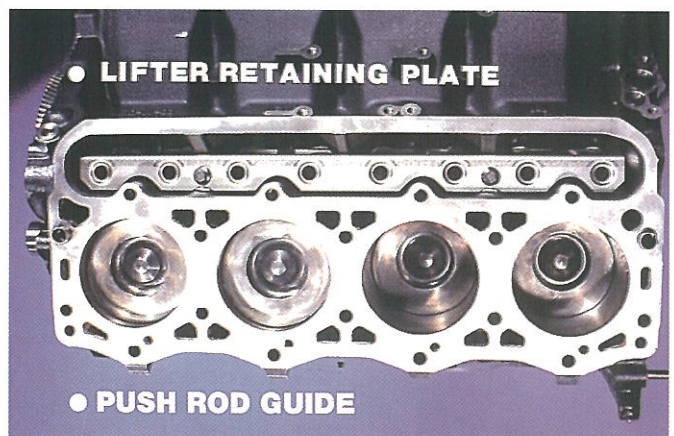

109

UNIQUE SERVICE PROCEDURES

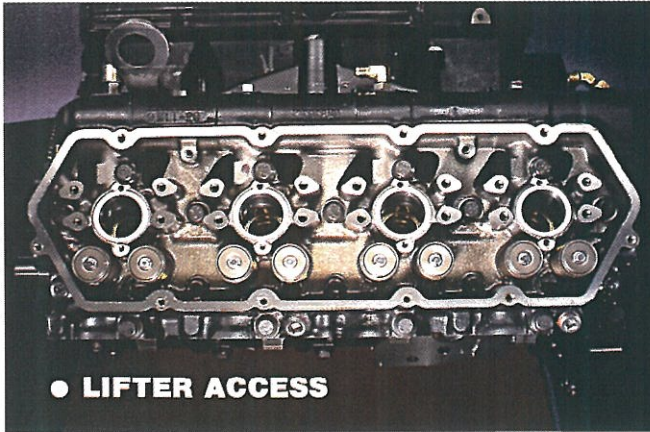

110

CRANKCASE

- The camshaft thrust plate is located between the camshaft gear and #1 journal.
- The camshaft gear is pressed onto the cam.

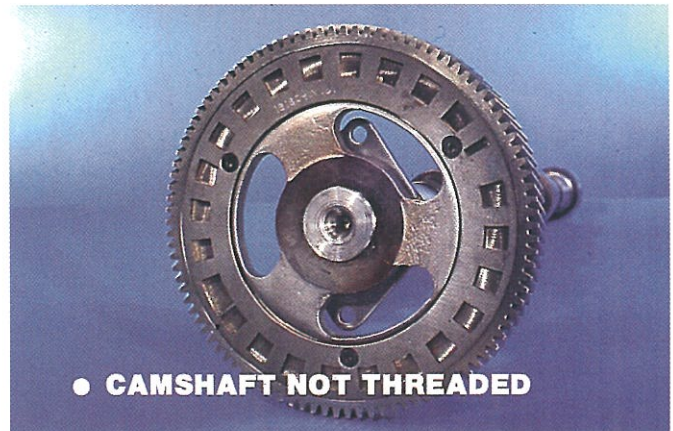

111

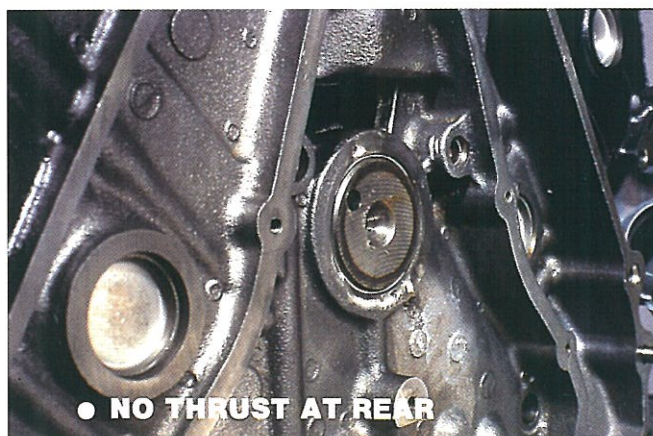

112

CRANKCASE

- Camshaft gear removal and installation should not be attempted with the camshaft in the engine, since the rearward movement of the camshaft is not limited.

UNIQUE SERVICE PROCEDURES

CYLINDER HEAD

- Glow plugs are under the valve cover and can be removed without removing rocker arms.
- The glow plug connector is a bullet connector pushed onto the glow plug.
- The glow plug tip extends into the combustion chamber, consequently the plug is longer than the IDI engine's plugs.
- Remove glow plugs, if heads are to be removed, to avoid damage.

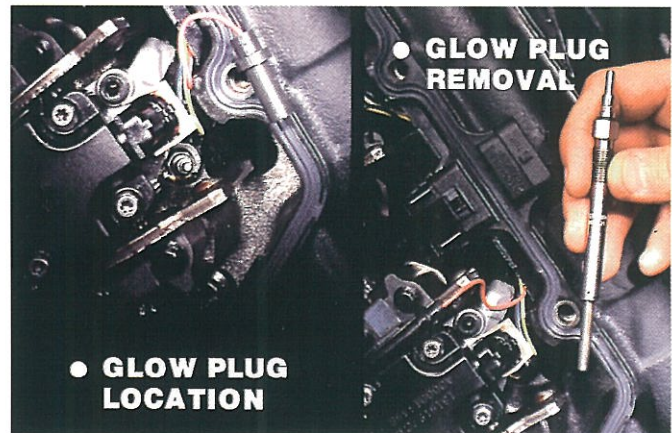

113

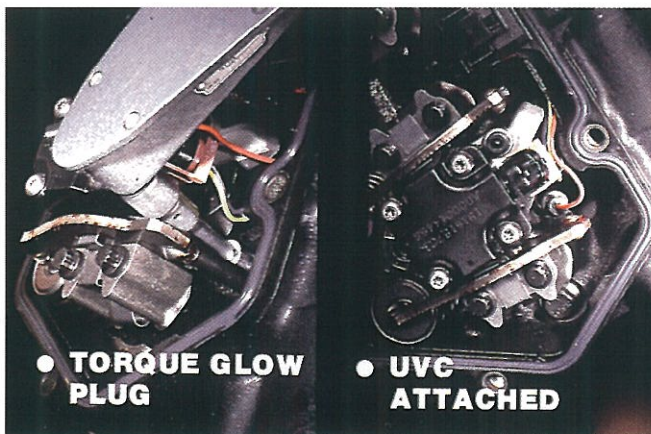

114

CYLINDER HEAD

- Glow plugs must be tightened to a specific torque to insure proper combustion seal. See service manual for specifications.

CYLINDER HEAD

- The UVC connector is removed from the injector by spreading the retaining clips and pushing down on the connector. Care must be taken so the retaining clips are not broken by spreading clips too far.

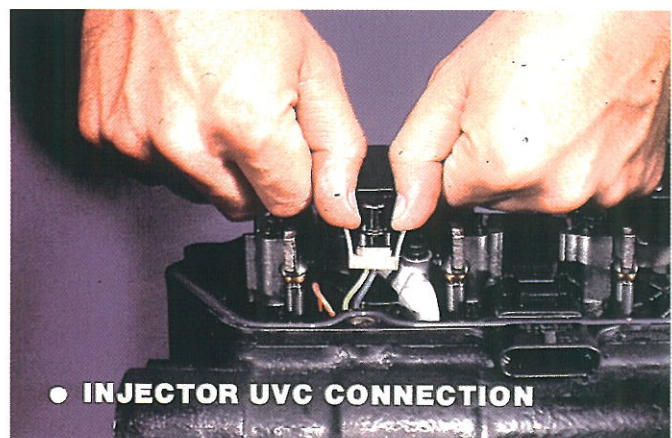

115

UNIQUE SERVICE PROCEDURES



116

HIGH PRESSURE PUMP

- Prior to removal of the high pressure pump or reservoir housing, the reservoir must be drained. This is accomplished by using a vacuum pump with a one quart container to extract the oil from the reservoir.
- If the reservoir is not drained, about one quart of oil will leak into the engine valley when the high pressure pump or reservoir is removed.

INJECTOR REMOVAL (1)

- The high pressure oil gallery plugs must be removed to drain the oil. This will drain the gallery so when the injector is removed the oil gallery will not drain into the combustion chamber.
- The drain procedure recommended above will prevent the possibility of hydraulic lock, which will damage the engine when the starter is engaged.



117

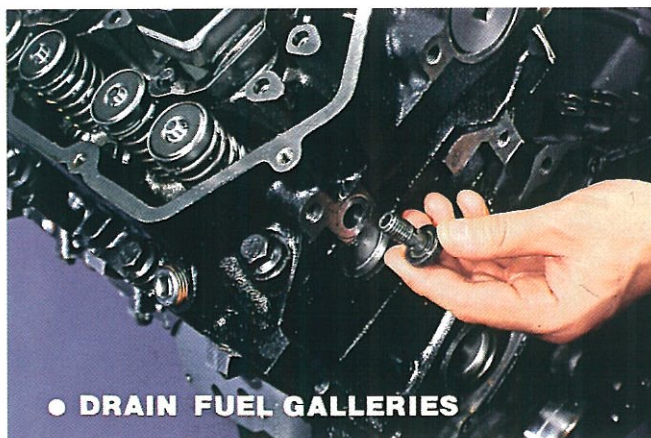

118

INJECTOR REMOVAL (2)

- The fuel gallery must also be drained prior to injector removal. This must be done so that when the injector is removed, the fuel does not drain into the combustion chamber.
- If the plugs at the front or rear of the engine are not accessible and any doubt exists whether liquid is on top of the piston, bar the engine over and use a vacuum pump to remove the liquid.

UNIQUE SERVICE PROCEDURES

INJECTOR REMOVAL (3)

- Remove the injector oil spill spouts prior to injector removal. The spill spout is bolted to the hold down clamp.
- The spill spout directs the oil that has been discharged from the injector into the camshaft area of the crankcase. This allows faster oil return to sump.

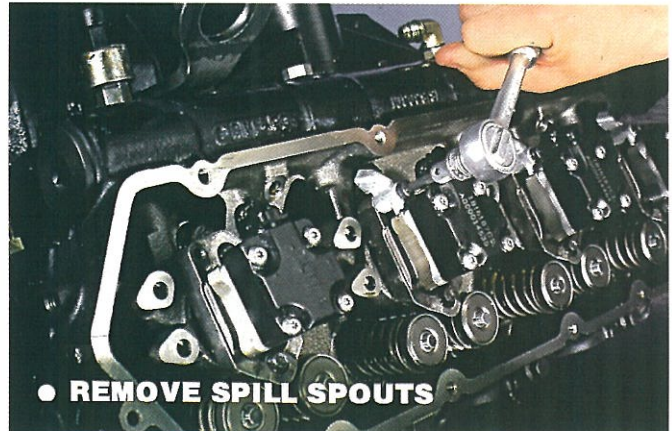

119

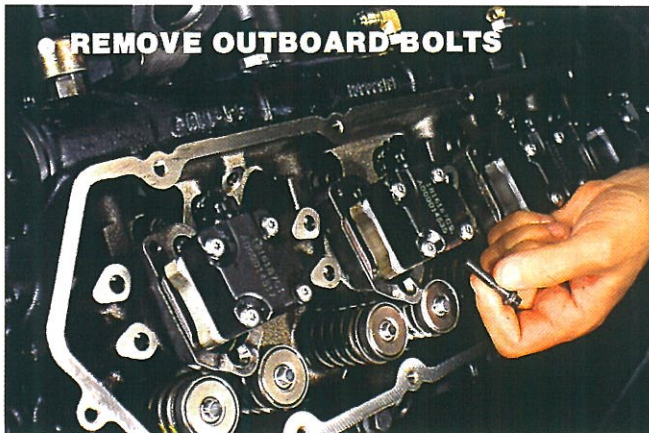

120

INJECTOR REMOVAL (4)

- The outboard injector hold down bolt is removed to remove the injector. The inboard (towards valley) cannot be removed until the injector is out of the cylinder head.
- The injector hold down is slotted to facilitate disassembly.
- The inward bolt does not need to be removed or loosened.

INJECTOR REMOVAL (5)

- With the outboard bolt removed, the hold down clamp can now be pushed towards the valley. This movement will allow the hold down clamp to be lifted over the inboard hold down bolt.

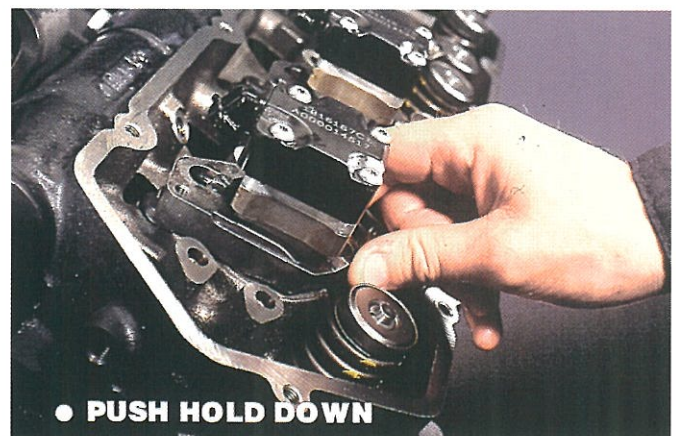

121

UNIQUE SERVICE PROCEDURES

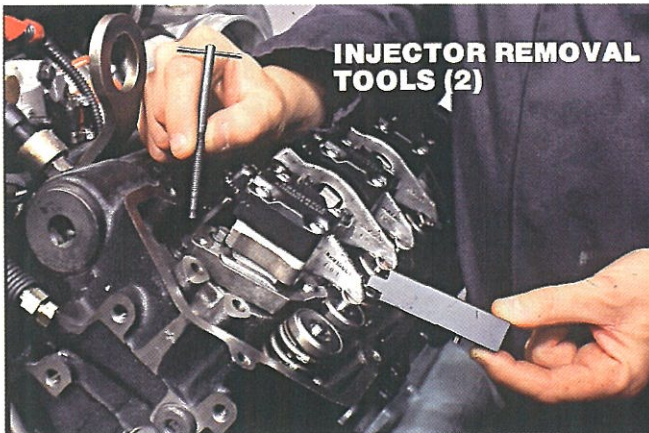

122

INJECTOR REMOVAL (7)

- With the hold down pushed toward the valley, place the removal tool under the injector hold down and install the T-handle bolt.
- Turning the T-handle will push the injector from its bore.

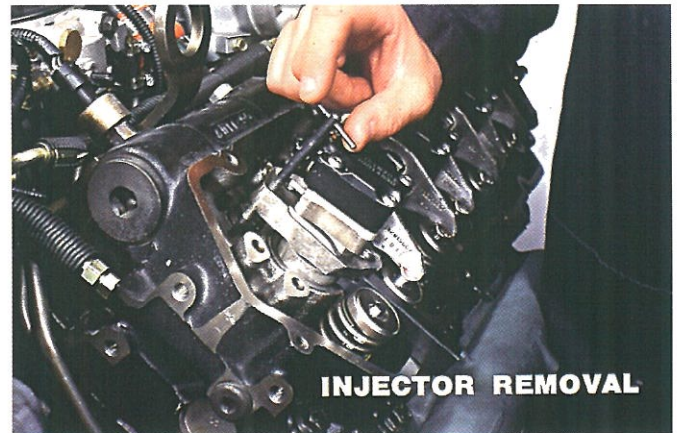

123

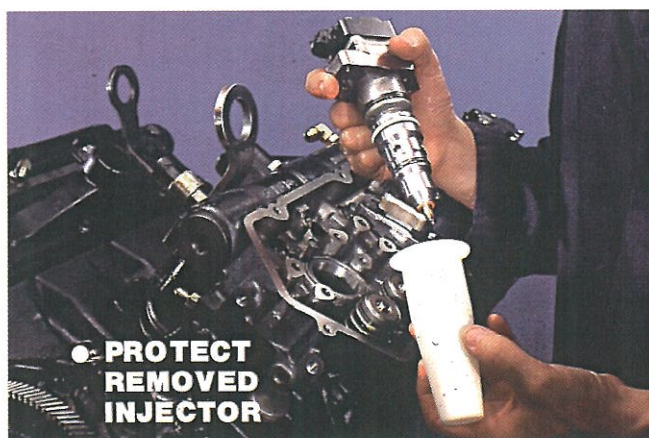

124

INJECTOR REMOVAL (8)

- The injector can be lifted from the cylinder head. This same process is to be used for all injectors.
- The injector should be placed in this protective sleeve for protection from contamination and tip damage. The sleeve tool #014-00933-2 is held on the injector by the injector "O"-rings.

UNIQUE SERVICE PROCEDURES

INJECTOR (9)

- Place injector and sleeve into holder tool, #014-00933-1, until ready for re-installation.



125

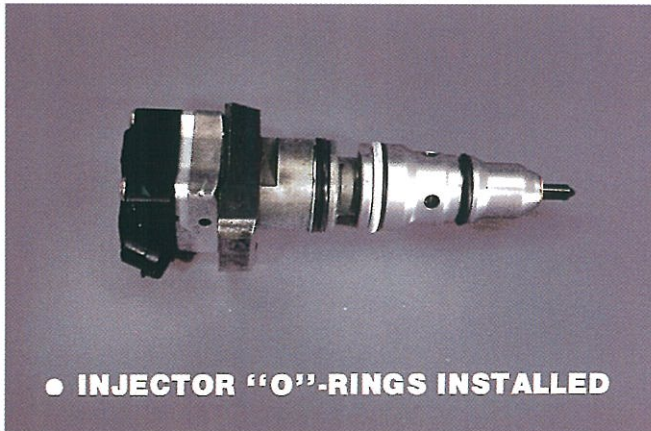

126

INJECTOR

- This shows the proper "O"-ring installation. The "O"-rings are color coded for location.
- Engine oil should be used to ease "O"-ring installation.

INJECTOR

- The "O"-rings are to be installed with the largest "O"-ring to the smallest (Top to Bottom).

1-Steel Back Up Ring	Upper Groove
1-Back Up Rect. Section Ring	Upper Groove
1-"O"-ring	Upper Groove
1-"O"-ring	Middle Groove
1-Back-Up Rect. Section Ring	Middle Groove
1-"O"-ring	Lower Groove
1-Copper Combustion Gasket	Bottom Surface

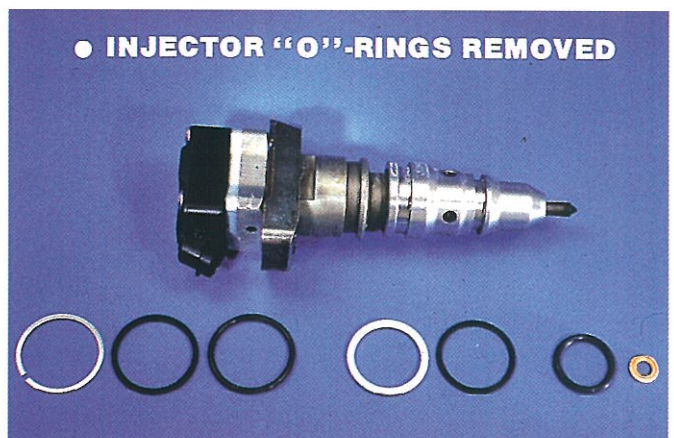

127

UNIQUE SERVICE PROCEDURES



● INJECTOR SLEEVE REMOVAL

128

CYLINDER HEAD

- With a wire brush clean up the injector sleeve bore in the cylinder head.

IMPORTANT;

- Remove all residual sealant from the sleeve seat in the cylinder head being careful not to damage the sleeve seat, i.e., scratch with a sharp tool, etc.



● CLEAN HIGH PRESSURE OIL GALLERIES

130

CYLINDER HEAD INJECTOR SLEEVE

- The injector sleeve penetrates the cooling system so prior to removing the sleeve, the cooling system must be drained.
- Plug the sleeve to prevent debris from entering the power cylinder if the sleeve is removed in the chassis. Tool # 014-00934-3.
- This tap tool, #014-00934-1, threads the sleeve, then is attached to a slide hammer to pull out the sleeve. Use the pilot collar to keep the tap centered in the injector bore.
- Thread the slide hammer into the injector sleeve top and remove the injector sleeve from the cylinder head.

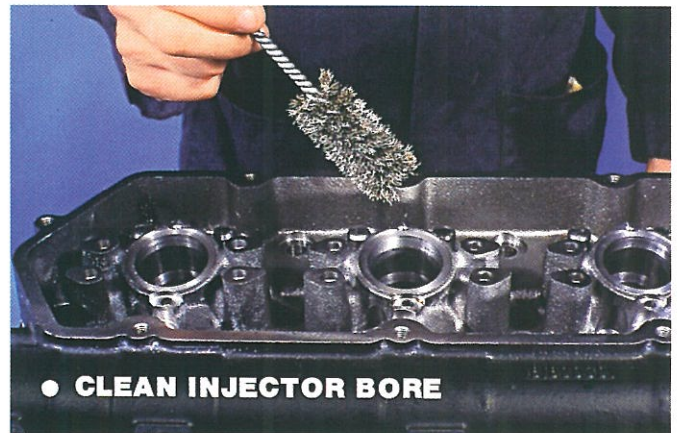

● CLEAN INJECTOR BORE

129

CYLINDER HEAD

- Use a rifle brush to clean out the high pressure oil galleries prior to installing new injector sleeve.

UNIQUE SERVICE PROCEDURES

CYLINDER HEAD

- Clean the fuel gallery prior to injector sleeve installation, to insure proper injector life.

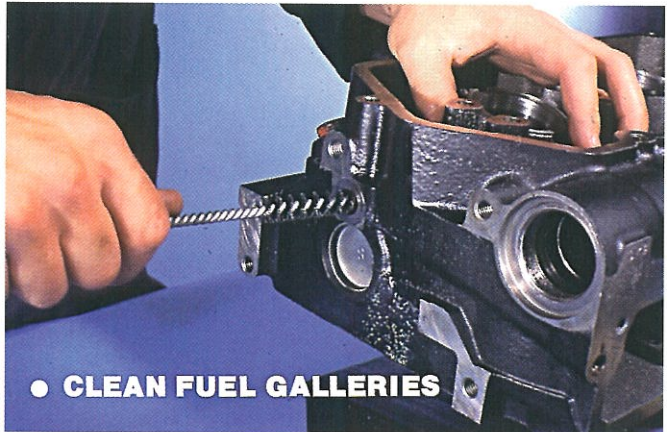

● CLEAN FUEL GALLERIES

131



● NEW INJECTOR SLEEVE
● INSTALLER TOOL

132

CYLINDER HEAD

- This special tool, #014-00934-4, is used to install the injector sleeve because it is formed to match the sleeve. This will not damage the sleeve during installation. There is an "O"-ring on the tool that retains the sleeve while it is being set into the bore.

CYLINDER HEAD

- With the injector sleeve on the installation tool, LOCTITE® No. 609 sealant should be applied. Note the two locations of sealant application.

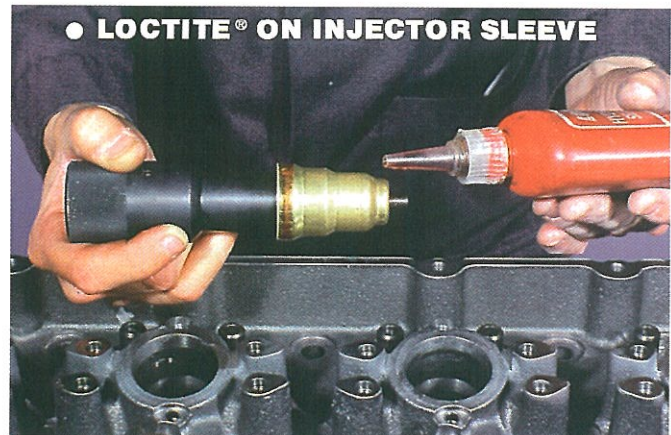

● LOCTITE® ON INJECTOR SLEEVE

133

UNIQUE SERVICE PROCEDURES

● INSTALL INJECTOR SLEEVE



134

CYLINDER HEAD

- Drive the sleeve into the injector bore until it bottoms in the cylinder head.

CYLINDER HEAD

- The (non-essential tool) pressure test plate has a rubber gasket glued to it for sealing of the cylinder head. **This test should only be done when the cylinder head is suspected of leaking coolant.**

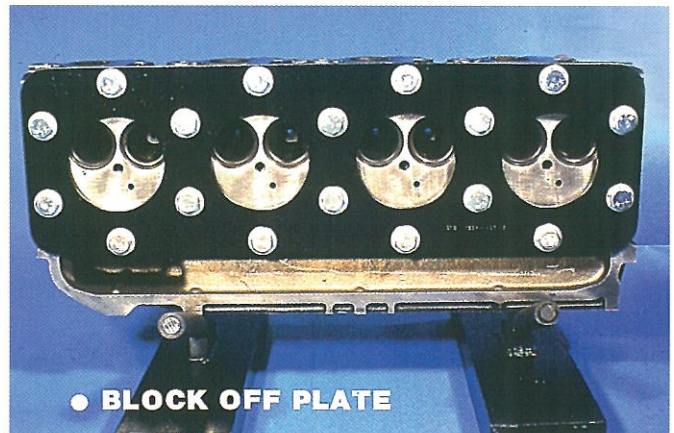

● BLOCK OFF PLATE

135

● CHECK VALVE PORT AREAS

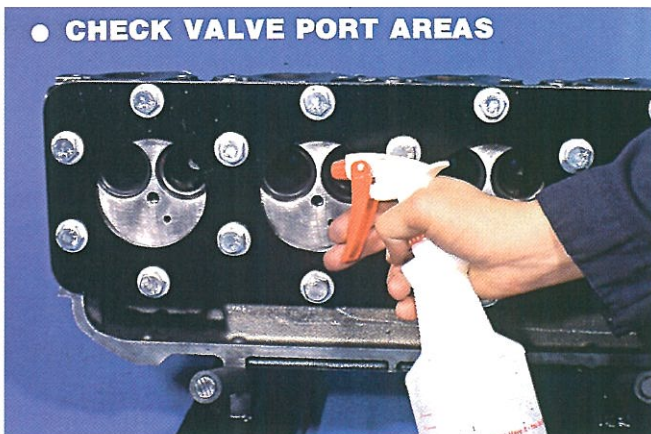

136

CYLINDER HEAD

- With regulated air pressure applied to the cylinder head inspect the valve port, injector hole, and glow plug holes for leakage, using soapy water solution.

UNIQUE SERVICE PROCEDURES

INTAKE AND EXHAUST VALVES

- The intake and exhaust valve heads are the same diameter, but the valve seat angles are different. The intake valve has a dimple on it and can also be identified by the P/N stamped on the valve head.
- INTAKE P/N 1814424C1
- EXHAUST P/N 1814280C1

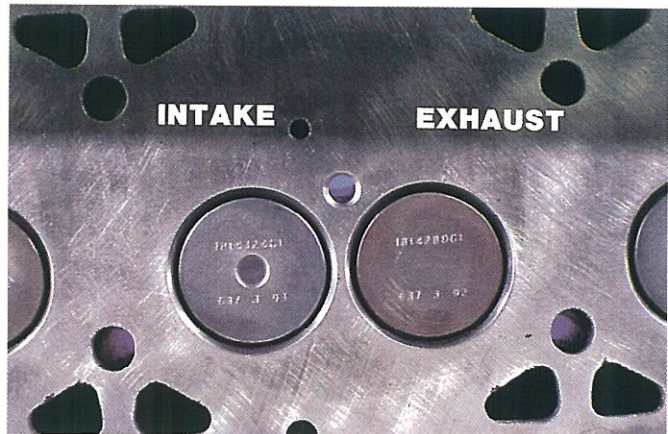

137

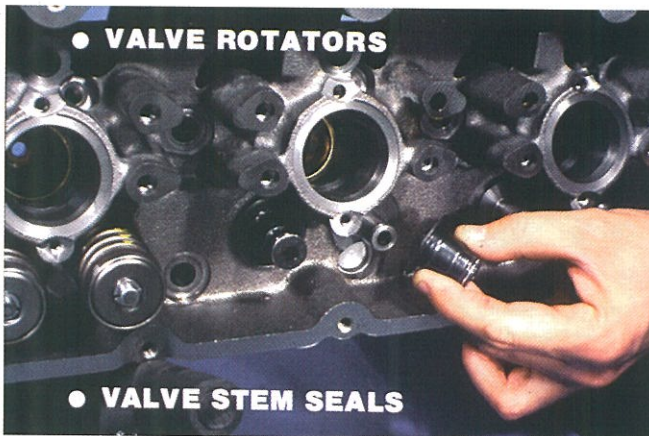

138

VALVE STEM SEALS AND ROTATORS

- The valve guide seals fit over the guide and have the valve spring seat as part of the seal. A small spring around the seal maintains proper sealing to the valve stems for excellent oil control. The valve rotators are located on top of the valve spring.

VALVE RECESSION

- A surface gauge is used to measure valve recession in the cylinder head. This dimension is important because it affects the compression ratio. Zero the surface gauge to the cylinder deck. Then measure on the valve head. The difference is the valve recession. Compare measured dimension to specifications in the service manual. Do this for both intake valve and exhaust valves.
- Valve recession is controlled by grinding seats and valves or replacing valves.

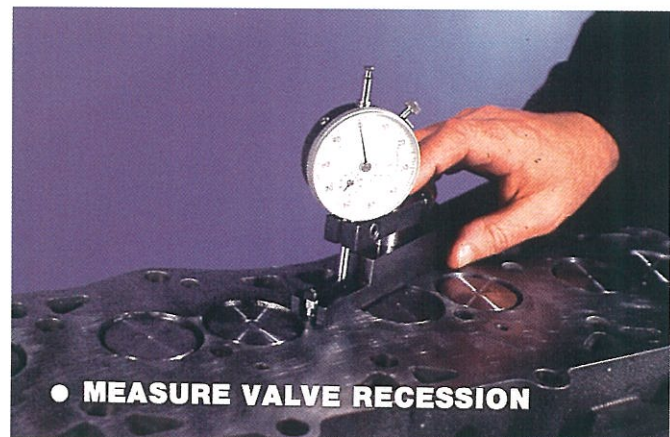

139

UNIQUE SERVICE PROCEDURES

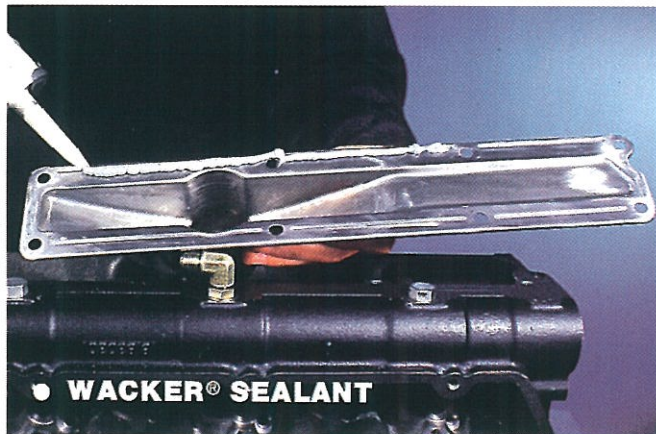

140

CYLINDER HEAD

- The intake manifolds are sealed with Wacker® T-95 RTV sealant to the cylinder head. Place manifold on head and secure with capscrews by tightening to specified torque.

CYLINDER HEAD

- The cylinder head lifting apparatus tool, #014-00932-2, simplifies handling the cylinder heads.

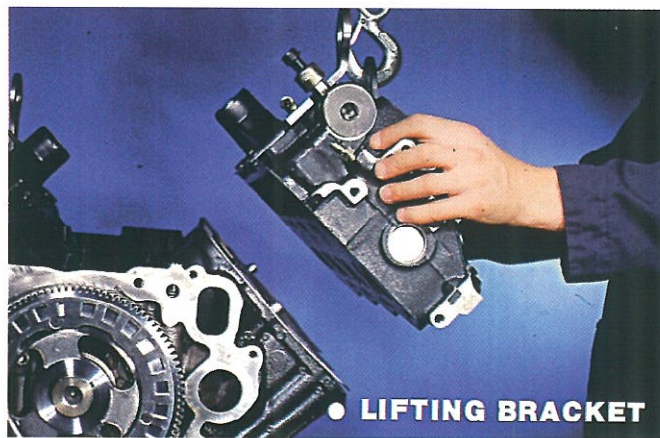

141

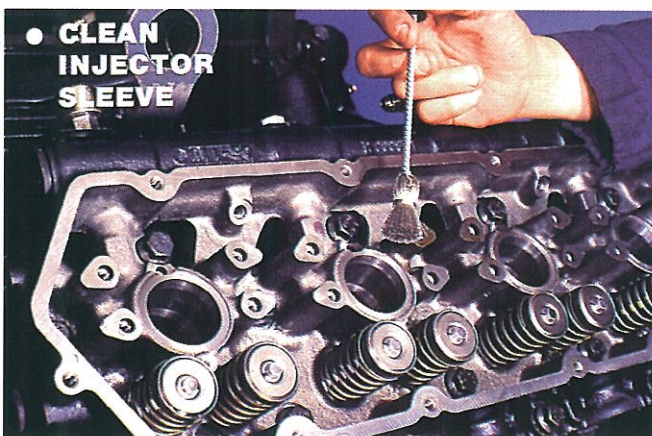

142

INJECTOR INSTALLATION (1)

- Using a brush, clean the injector sleeve prior to injector installation.

UNIQUE SERVICE PROCEDURES

INJECTOR INSTALLATION (2)

- Check torque on inboard injector hold down bolts.
- Lubricate injector "O"-rings with clean engine oil prior to injector installation. Use grease on the copper gasket to retain it to the injector during installation.

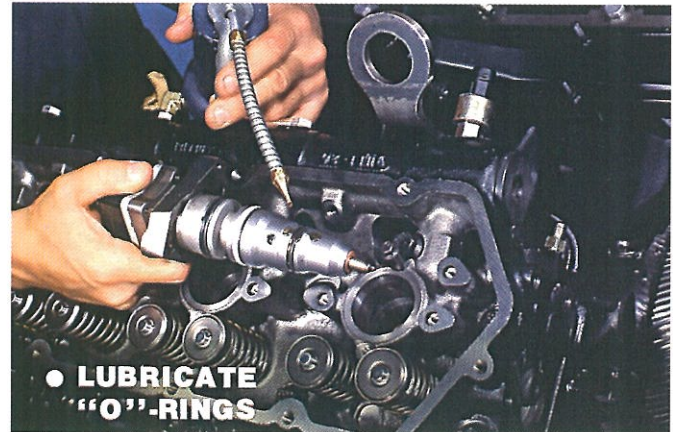

143

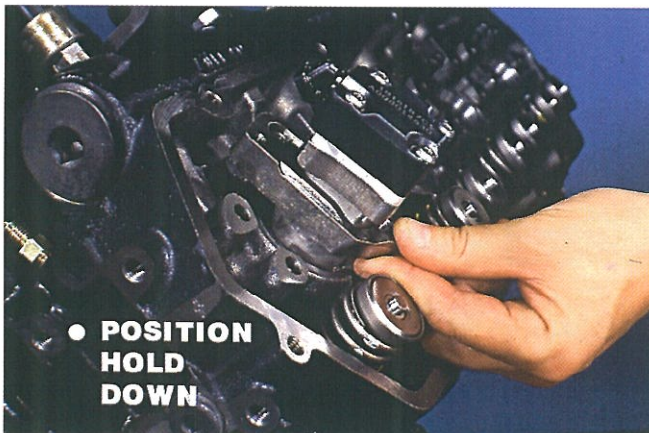

144

INJECTOR INSTALLATION (3)

- Set the injector in the bore and push the hold down towards the valley so it drops over the in-board hold down shoulder bolt.

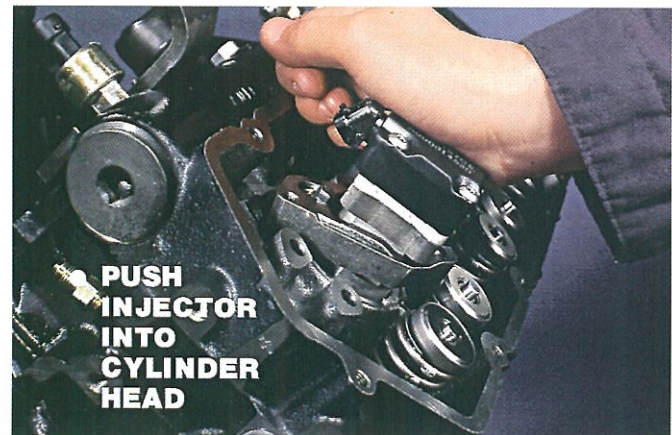

145

INJECTOR INSTALLATION (4)

- By hand, push the injector in place. **Never pound or pry on the solenoid as this could damage the injector.** Where space is limited use the special tool to position the injector.

UNIQUE SERVICE PROCEDURES



146

INJECTOR INSTALLATION (5)

- An installation tool, #T94T-9000-AH2, should be installed to properly seat the injector in the sleeve.

INJECTOR INSTALLATION (6)

- With a wrench, tighten the installer bolt to bottom the injector into the bore, then remove the tool. At this time, the hold down will fall into place, so the out-board bolt can be installed.



147

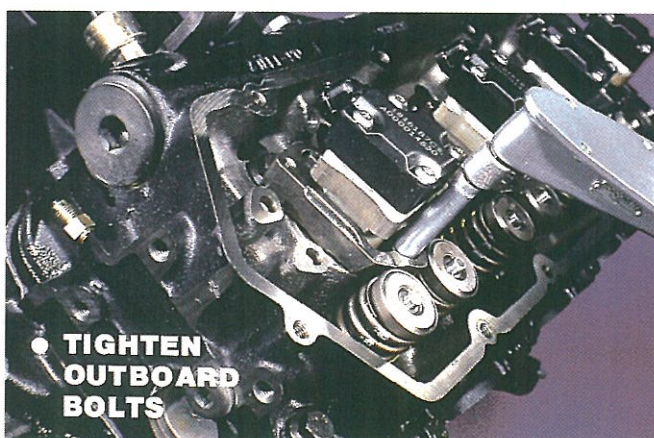

148

INJECTOR INSTALLATION (7)

- Tighten the out-board injector hold down bolt to specified torque. Specifications are in the service manual.

UNIQUE SERVICE PROCEDURES

INJECTOR INSTALLATION (8)

- Install the injector oil spill spout. Tighten capscrew to specified torque. Injector must be tightened before tightening the oil spill spout.

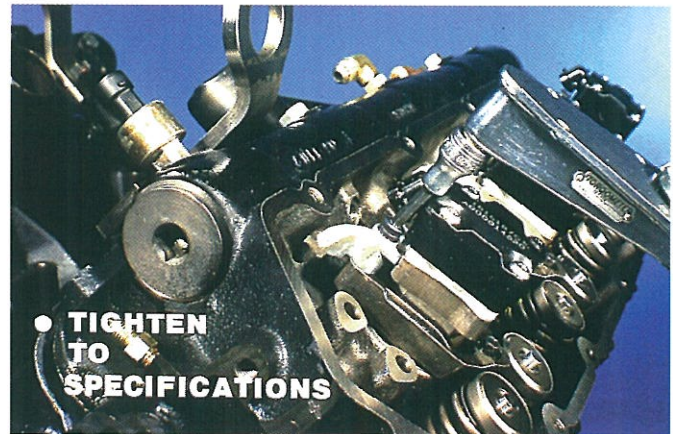

149

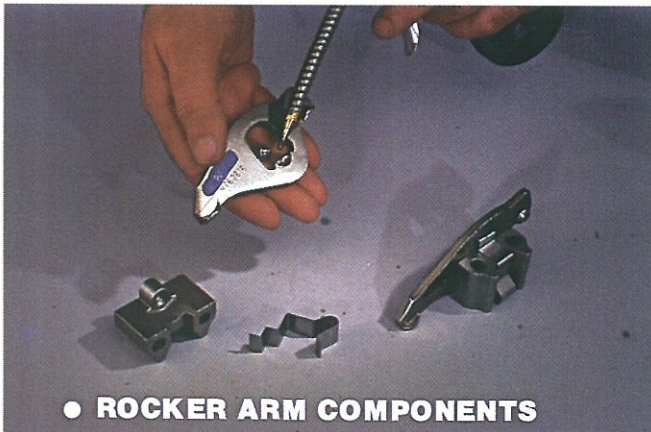

150

ROCKER ARM ASSEMBLY

- The rocker arm ball and socket should be inspected for wear. Removal of the retaining clip will allow disassembly of the rocker. After inspection the parts are to be lubricated for re-assembly.
- Polishing is normal on these components but measurable wear requires replacement.

ROCKER ARM ASSEMBLY

- Assemble the parts in proper orientation as rocker arm can either be an intake or exhaust. Good mechanical practice is to assemble these components in the same position as disassembled.
- The clip holds the parts together as an assembly.



151

UNIQUE SERVICE PROCEDURES

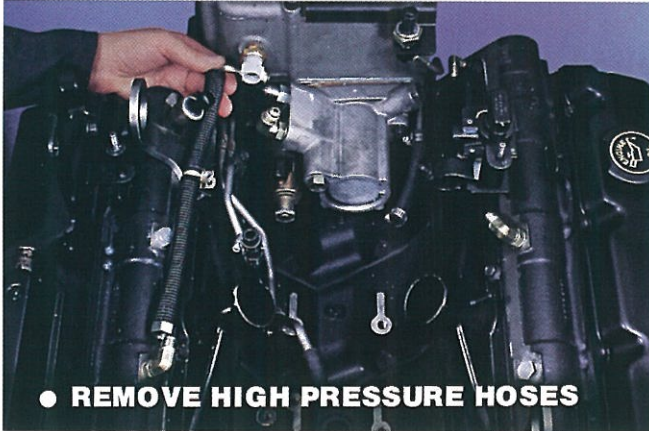

152

HIGH PRESSURE PUMP RESERVOIR

- Remove reservoir once oil has been extracted. Note location of stud bolts for proper re-assembly.



153



154

HIGH PRESSURE PUMP

- To remove the high pressure pump, first remove the high pressure hoses to each cylinder head.
- Notice the location of the ICP sensor in the cylinder head gallery.

IMPORTANT

- Always use FORD specified hoses designed for this application.

HIGH PRESSURE PUMP

- After removing the front access cover plate the retaining bolt for the high pressure pump gear to shaft can be removed.
- The gear is not keyed to the pump or timed to the camshaft.

UNIQUE SERVICE PROCEDURES

HIGH PRESSURE PUMP

- The high pressure pump is sealed to the front cover with a reusable gasket and attached with two bolts. The gear is not tapered or pinned to the pump shaft.

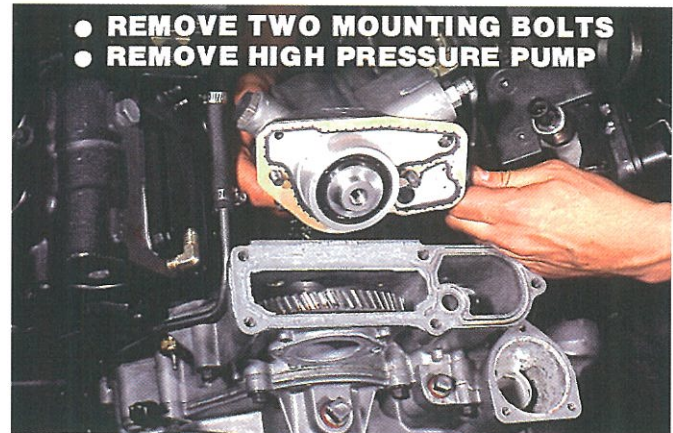

155

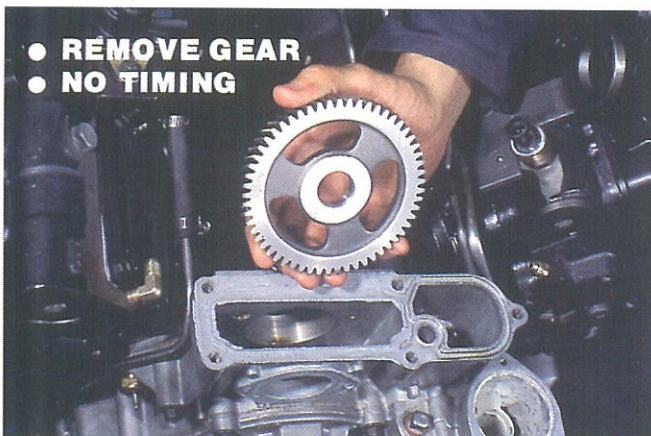

156

HIGH PRESSURE PUMP

- The drive gear is not timed.
- The high pressure pump has a relief valve that will dump if pressure goes above 4000 psi. This dumps into the gear train area of the front cover and returns to sump.

HIGH PRESSURE PUMP INSTALLATION

- Install the reusable gasket and bolt the pump to the front cover. Be sure the gear is in the front cover prior to installing pump.

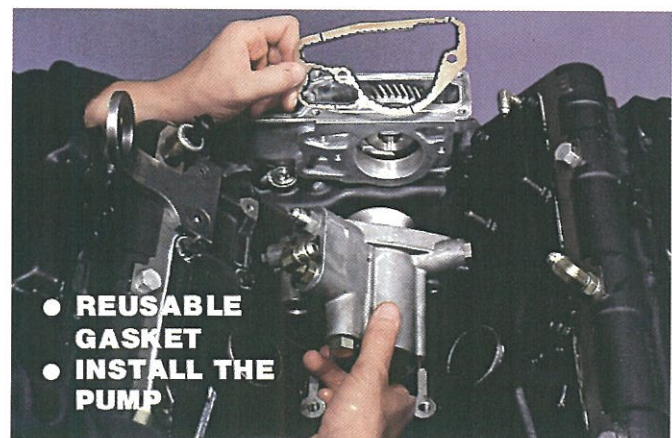

157

UNIQUE SERVICE PROCEDURES

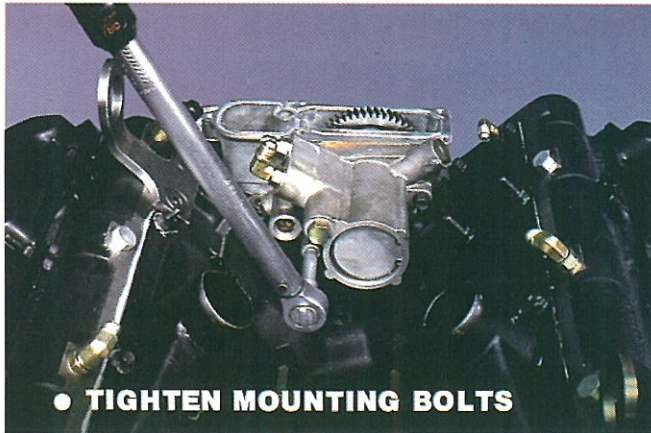

158

HIGH PRESSURE PUMP

- Install the high pressure pump gear to shaft retaining bolt and tighten to specifications.

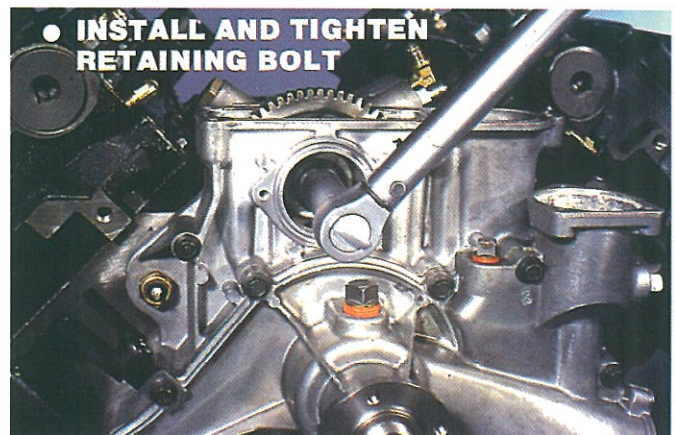

159

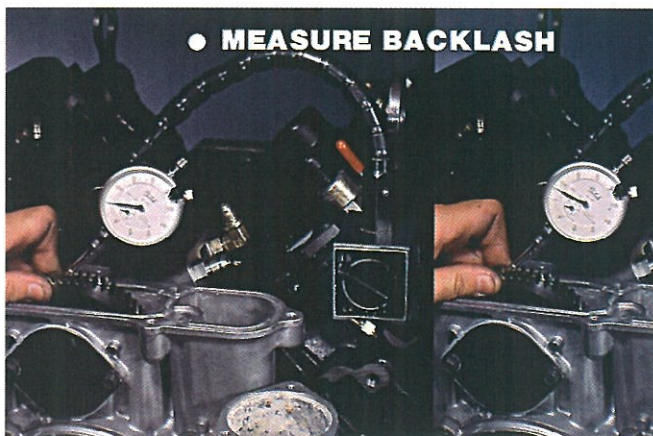

160

HIGH PRESSURE PUMP

- Be sure the center of the gear is on the pump shaft, and engaged to the cam gear before tightening the pump mounting bolts. If the gear is off center, it could get jammed between the shaft and front cover.
- Tighten bolts to the proper torque. Specifications are in the service manual.

HIGH PRESSURE PUMP

- Check the pump gear to camshaft gear back lash. Rock the gear one way and zero the indicator, then rock the gear the opposite direction and the indicator reading is the gear backlash. Specifications are in the service manual.

UNIQUE SERVICE PROCEDURES

HIGH PRESSURE PUMP

- Use Wacker® T-95 RTV sealant on the plate and retaining bolt threads to ensure sealing.

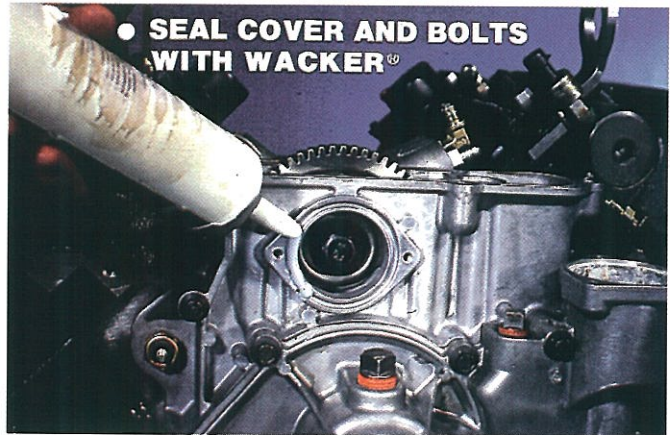

161

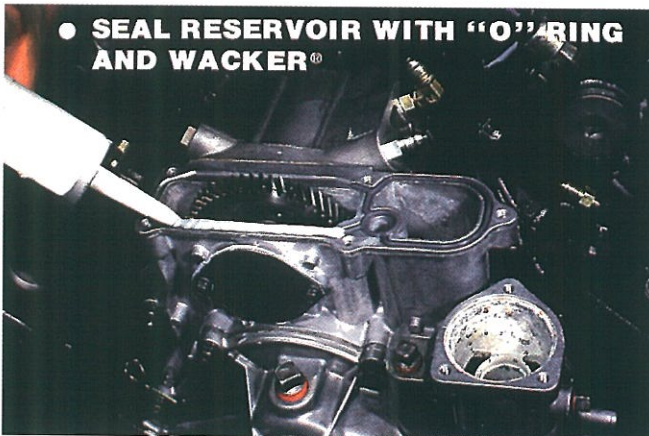

162

HIGH PRESSURE PUMP

- The engine oil pressure side of the reservoir is sealed by an "O"-ring and the gear train side with Wacker® T-95 RTV sealant.

HIGH PRESSURE PUMP

- The aluminum front cover requires that the reservoir bolts (5) be tightened to specified torque. Specifications are in the service manual.

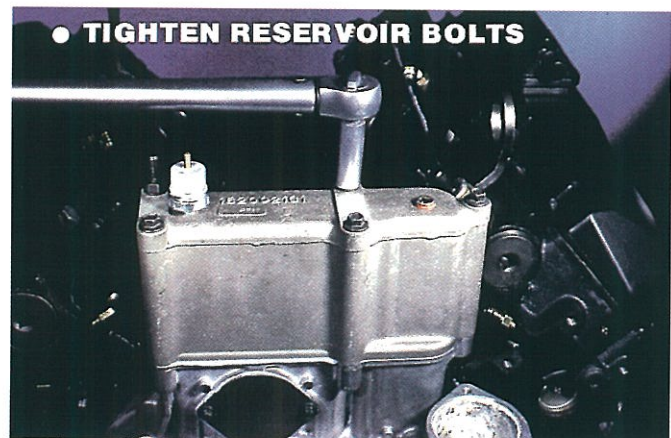

163

UNIQUE SERVICE PROCEDURES



164

HIGH PRESSURE PUMP

- To remove the regulator valve from the pump, remove the solenoid from the regulator valve. A retaining nut secures the solenoid to the valve body.
- This valve is used to regulate pressure in the high pressure lube system during engine operation. The valve is sealed to the pump housing by an "O"-ring. The reservoir does not need to be empty to replace this valve as long as it is installed in a timely manner.
- CAUTION: The IPR must be kept clean. The valve should be rinsed in clean solvent and blown dry.

INSTALLING IPR

- The bore should be swabbed clean prior to installing the IPR.
- Be sure the valve starts into the threads squarely and can be turned by hand until the "O"-ring seal contacts the pump housing.



165



166

TIGHTEN IPR

- This valve must be tightened to the specified torque into the aluminum pump housing. Over-tightening may distort the valve body and cause it not to function properly.

UNIQUE SERVICE PROCEDURES

INSTALLING IPR SOLENOID

- The jam nut that holds the solenoid must be tightened to the torque specified in the service manual. If the jam nut comes loose the IPR won't function properly.



167

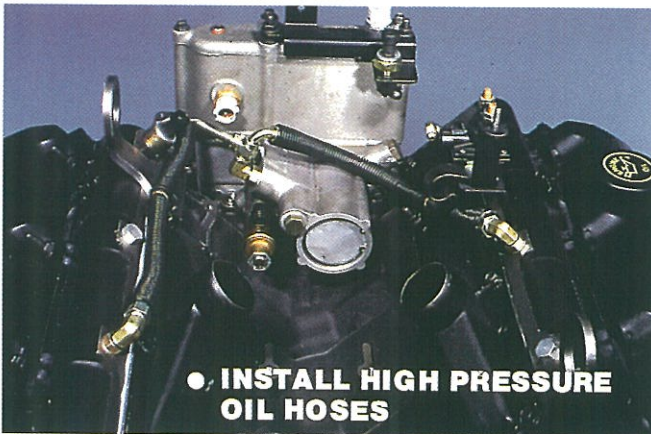

168

HIGH PRESSURE HOSES

The hoses are made specially to withstand the pressure and temperature of this system. Use only FORD certified replacement hoses.

FUEL FILTER ASSEMBLY REMOVAL

- To remove the fuel filter housing from the engine valley, the filter must be drained using the water drain lever (yellow), at the top of the housing. Then loosen the transfer pump to filter hose clamps, as well as, the filter drain clamp.



169

UNIQUE SERVICE PROCEDURES

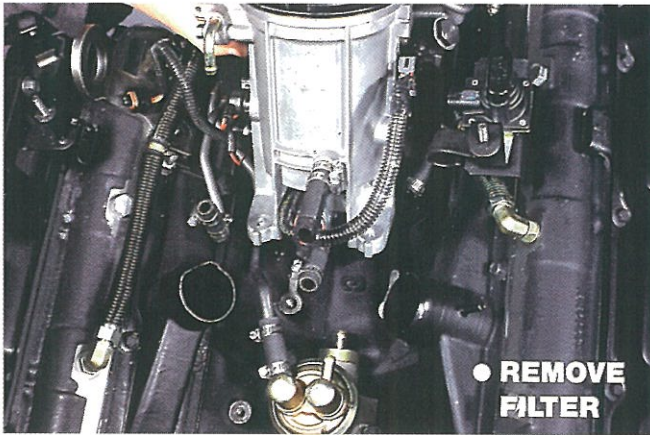

170

FUEL FILTER ASSEMBLY REMOVAL

- Remove the two mounting bolts from the engine valley and remove the filter assembly from the valley.

TRANSFER PUMP

- The fuel line assembly for the cylinder heads is secured by a bolt and sealed by a coated aluminum gasket on each side of the banjo part of the assembly. The lines are sealed by square cut "O"-rings at each cylinder head.



171

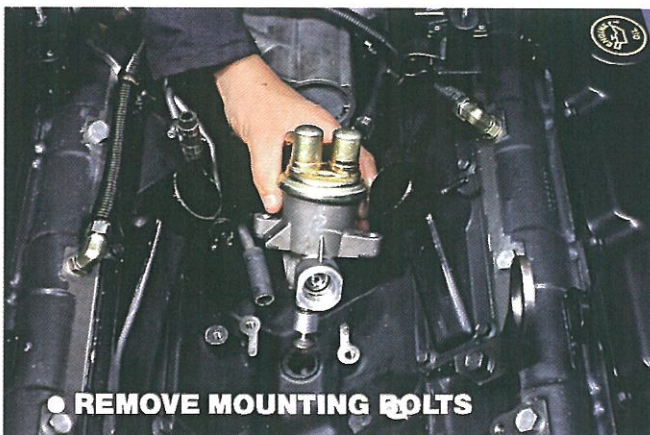

172

TRANSFER PUMP

- After removing the two mounting bolts that secure the pump to the crankcase the pump can be lifted from the valley. Care must be taken so that nothing falls into the open bore and onto the camshaft lobe.

UNIQUE SERVICE PROCEDURES

TRANSFER PUMP INSTALLATION

- Lube the "O"-ring and bottom side of tappet with engine oil prior to setting into crankcase. The pump bolts must be tightened evenly. If the cam lobe is at its highest point to the tappet the pump will have to be drawn down to the crankcase mounting pad. If not drawn evenly by the two bolts, the nose of the pump could get broken.

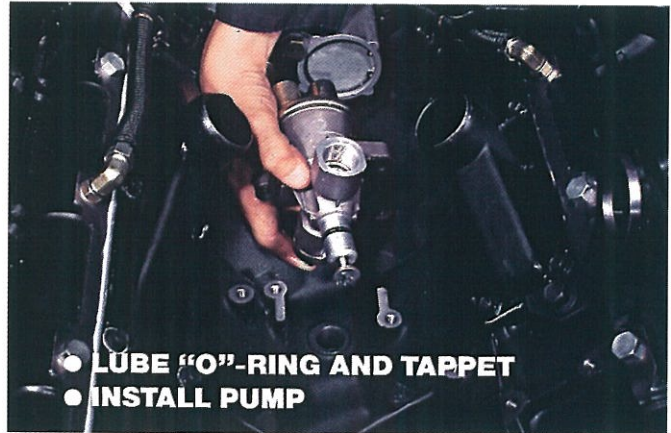

- LUBE "O"-RING AND TAPPET
- INSTALL PUMP

173



- INSTALL BANJO FITTING

174

TRANSFER PUMP INSTALLATION

- Install new square cut "O"-rings on the cylinder head ends of the fuel line. Be sure the tang on the banjo aligns with the flat on the transfer pump body. This tang and flat limit the twisting of the banjo while the fuel banjo nut is being tightened. Loosely assemble the banjo fitting with new seal rings. Start compression nuts on fitting on each head, then tighten all three fittings to specified torque. Specifications are in the service manual.

TRANSFER PUMP

- With hose clamps loose on the hoses, set the filter in the valley and align the hoses with the proper transfer pump port. Tighten the mounting bolts for the fuel filter base and then tighten the fuel line hose clamps.



- INSTALL FUEL FILTER

175

UNIQUE SERVICE PROCEDURES



- REMOVE COMPRESSOR OUTLET "Y"-PIPE

176

TURBOCHARGER

- Remove the "Y"-pipe from compressor outlet to the intake manifolds. A special "O"-ring is used to seal the "Y"-pipe to compressor housing.

TURBOCHARGER

- Remove the two nuts and two bolts that hold the turbine collector to the turbine inlet housing of the turbocharger. A gasket is used to seal this connection.

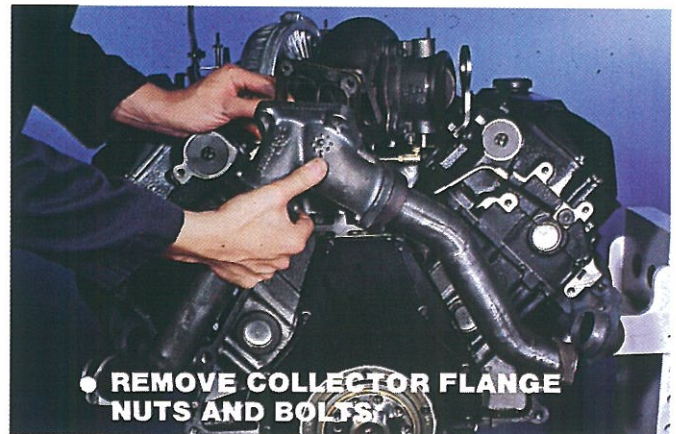

- REMOVE COLLECTOR FLANGE NUTS AND BOLTS

177

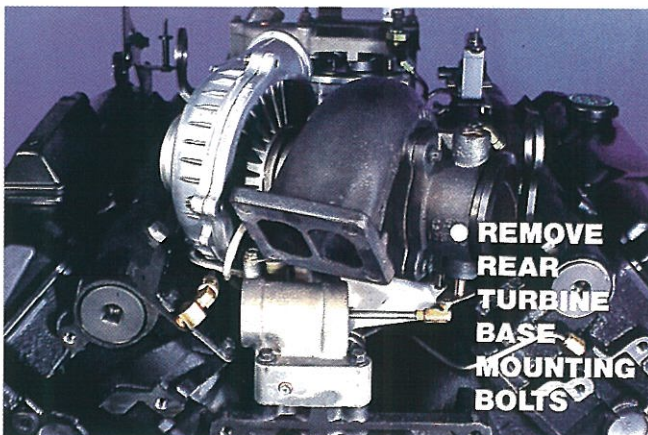

- REMOVE REAR TURBINE BASE MOUNTING BOLTS

178

TURBOCHARGER

- The turbocharger and pedestal must be removed as an assembly.
- Remove the two rear turbocharger pedestal mounting bolts.

UNIQUE SERVICE PROCEDURES

TURBOCHARGER

- Remove the front turbocharger pedestal bolts and lift from crankcase.

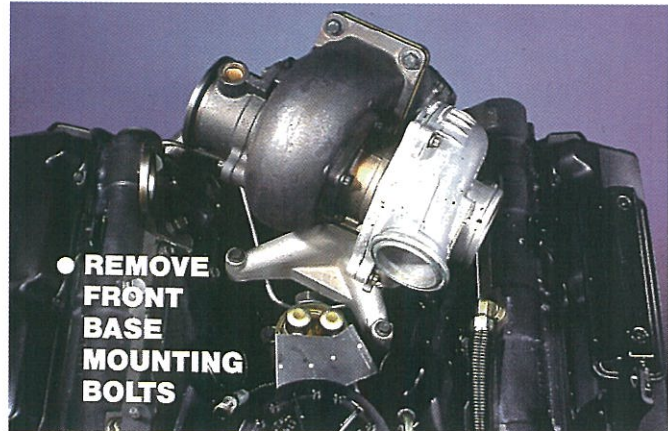

179

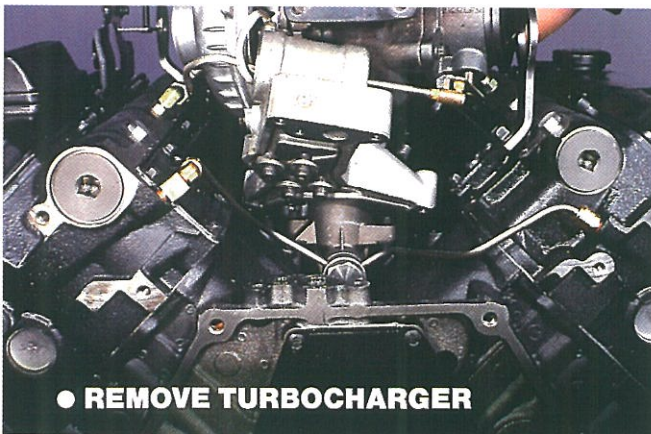

180

TURBOCHARGER

- The oil supply for the turbocharger is from the #5 main oil gallery. Oil is directed from the gallery up through a passage to the mounting pad. Oil returns to the crankcase rear plate area back to sump through the larger of the two holes.

TURBOCHARGER INSPECTION

- To remove the EBP device housing from the turbine, first remove the actuator rod by sliding the collar and pushing the rod down from the ball stud connection.
- The rod has some preload so it will move inward towards the base when released.



181

UNIQUE SERVICE PROCEDURES

● REMOVE EBP BUTTERFLY

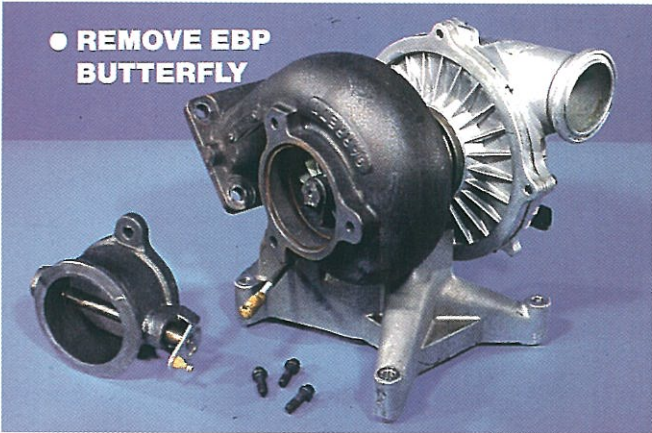

182

TURBOCHARGER INSPECTION

- After removing the three EBP device housing bolts, the device can be removed from the turbine housing. A metal to metal flange seal is used for this connection.

TURBOCHARGER INSPECTION

- When the four bolts are removed from the bottom of the turbocharger base the turbocharger can be separated from the mounting base. Two "O"-rings seal the turbocharger to base. Oil supply is the smaller hole, while oil drain is the larger.

● REMOVE TURBOCHARGER BASE



183

● REMOVE EBP SOLENOID

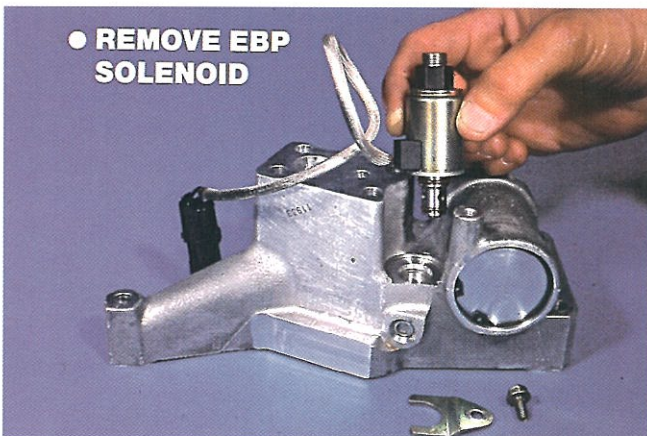

184

TURBOCHARGER INSPECTION

- The EBP solenoid is used to restrict oil return from the actuator piston which activates the EBP device. This restricts the exhaust flow causing the engine to warm up fast creating cab heat sooner.
- The PCM uses the EBP sensor to monitor the pressure in the right manifold and make adjustments to the position of the EBP device as needed.

UNIQUE SERVICE PROCEDURES

TURBOCHARGER PEDESTAL INSPECTION

- To inspect and rebuild the EBP actuator piston, first remove the snap ring from the housing.



185

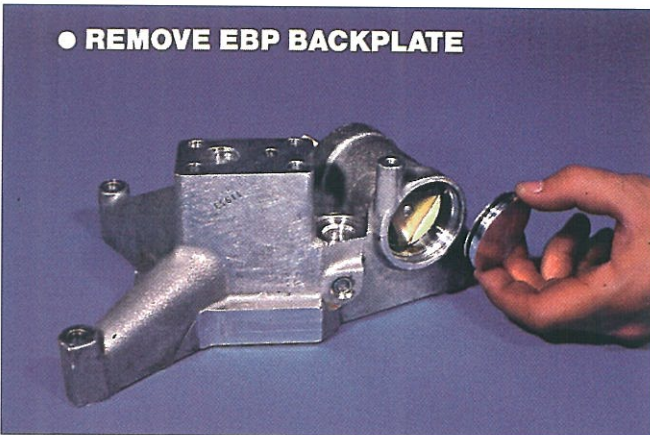

186

TURBOCHARGER PEDESTAL INSPECTION

- By tapping on the actuator rod, the end plate will be removed from the housing. Note the "O"-ring used to seal the end plate to the housing.

TURBOCHARGER INSPECTION

- The actuator piston can now be removed from the housing for inspection and repair. Inspect the housing bore for nicks or burrs that could damage the "O"-rings. Replace if necessary.

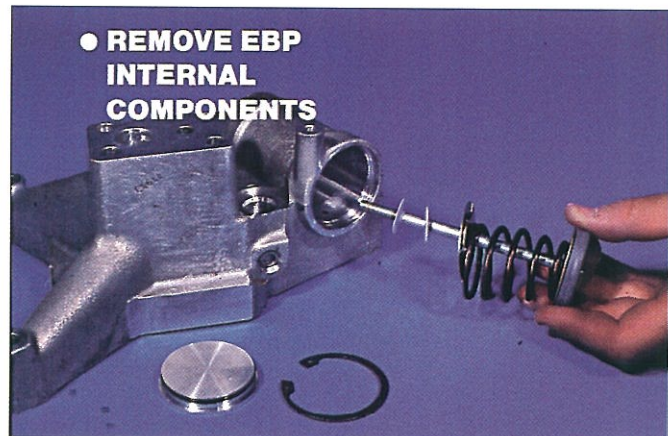

187

UNIQUE SERVICE PROCEDURES



188

TURBOCHARGER ASSEMBLY TO PEDESTAL

- Using new "O"-ring seals between the turbocharger and turbocharger base, install and tighten the base bolts.

TURBOCHARGER PEDESTAL REASSEMBLY

- Lubricate "O"-rings prior to reassembly into the housing. Be sure all parts are clean. Install end plate and snap ring.

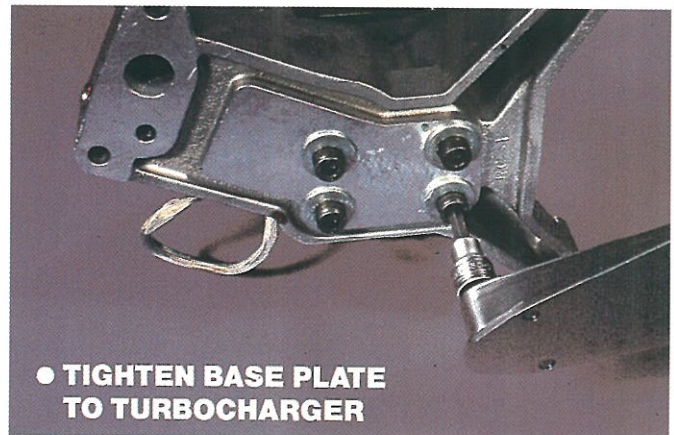

189

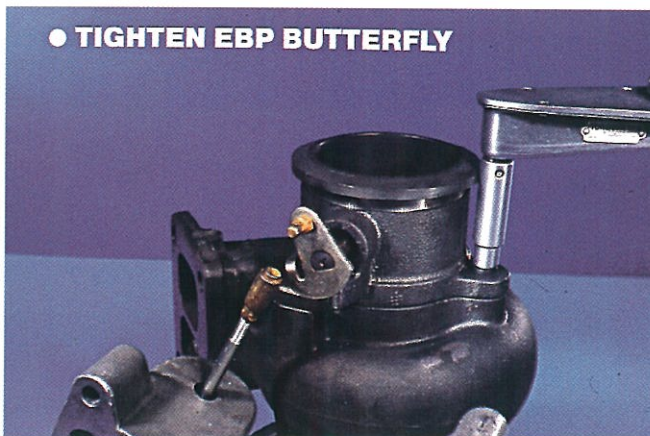

190

TURBOCHARGER INSPECTION

- Mount the EBP device to the turbine housing and tighten the 3 retaining bolts to the proper torque. Never Seize® is required on these bolts.

UNIQUE SERVICE PROCEDURES

EBP ASSEMBLY

- With the actuator rod connected to the EBP device, the tension to move the rod must be set. Using a spring scale, pull on the actuator rod until the rod begins to move and record this reading. To increase tension, disconnect the rod and turn the swivel in towards the base and connect to the device. Re-check. Thread the swivel away from the base to decrease the tension. Adjust to specifications shown in the service manual.

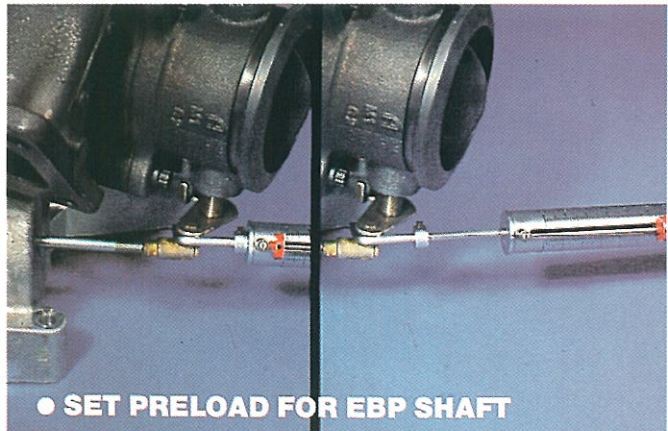

191

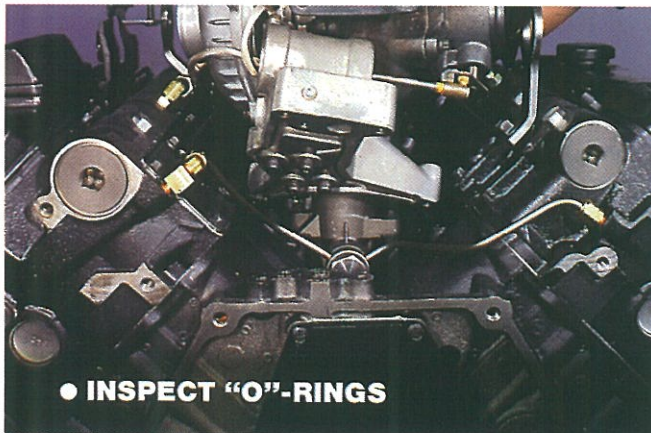

192

TURBOCHARGER INSTALLATION

- After inspecting mounting surfaces, install new seal "O"-rings into the crankcase

TURBOCHARGER INSTALLATION

- Set turbocharger on crankcase and tighten the four mounting bolts. Install the turbine collector piping and the compressor outlet "Y"-pipe to the intake manifolds.

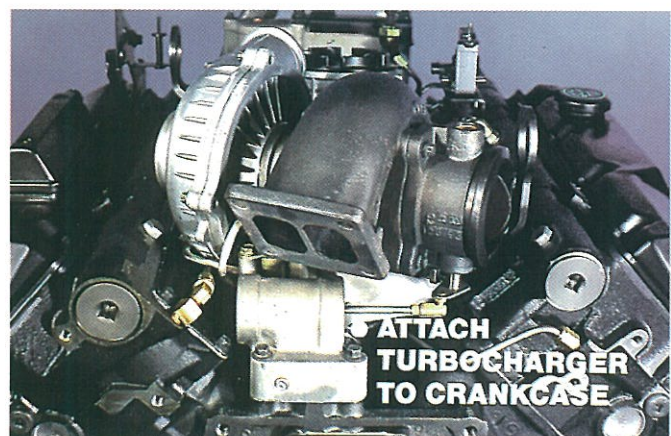

193

UNIQUE SERVICE PROCEDURES

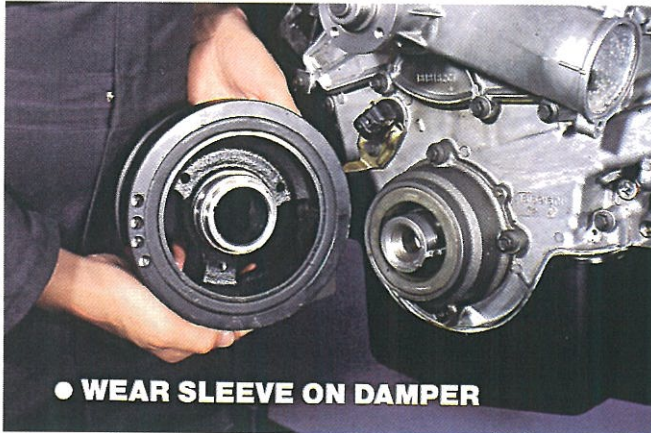

194

FRONT SEAL/OIL PUMP

- The damper incorporates a wear sleeve for the crankshaft front seal. The front seal is housed in the oil pump housing.

FRONT SEAL/OIL PUMP

- The front seal can be removed without removing the oil pump housing. Insert the tool into the lip of the seal. Roll the front seal out of the oil pump housing.

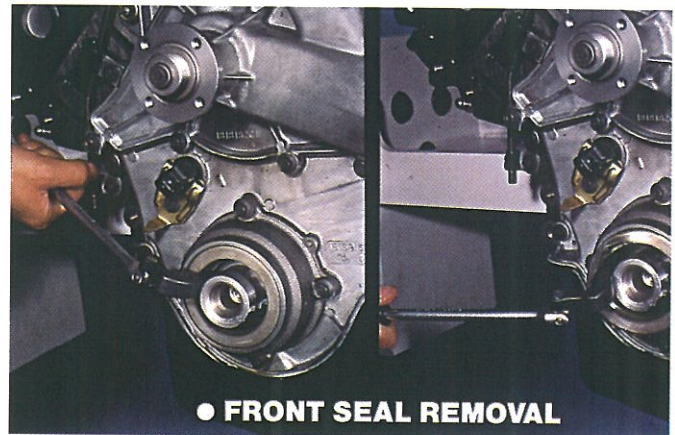

195

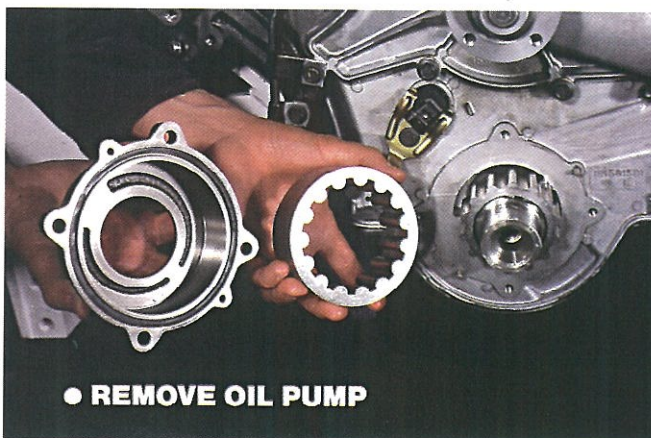

196

FRONT SEAL/OIL PUMP

- Four bolts attach the lube oil pump housing to the engine. The oil pump housing is centered to the crankshaft by dowel pins in the front cover.

UNIQUE SERVICE PROCEDURES

FRONT SEAL/OIL PUMP

- The outer gerotor is driven by the inner gerotor which is driven by the crankshaft. Oil is pulled into the oil pump at the lower slot and pressurized for delivery to the engine at the upper slot.

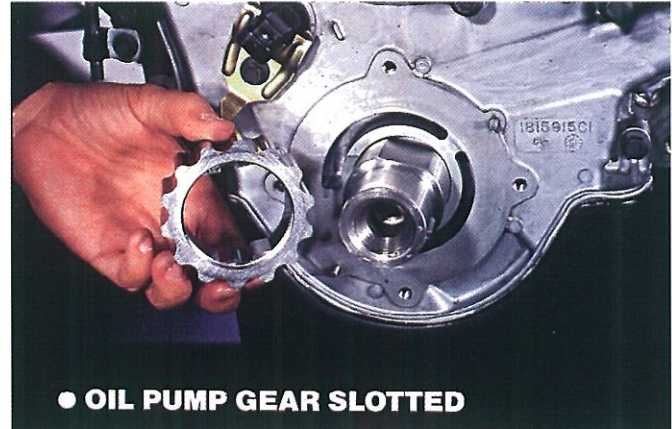

● OIL PUMP GEAR SLOTTED

197

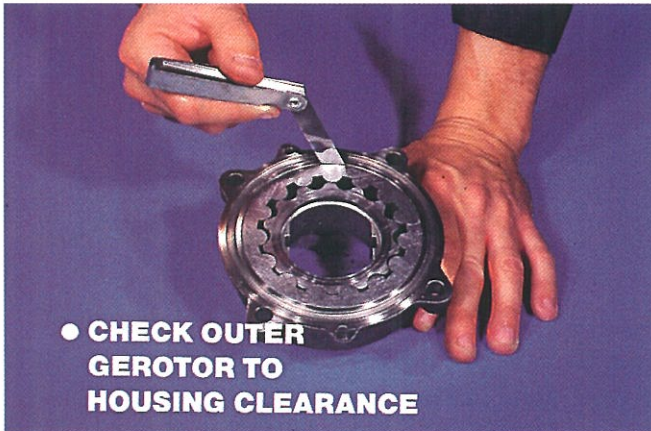

● CHECK OUTER GEROTOR TO HOUSING CLEARANCE

198

FRONT SEAL/OIL PUMP

- Measure the clearance of the outer gerotor to housing using a feeler gauge. See service manual for specifications.

FRONT SEAL/OIL PUMP

- Check oil pump gerotors axial clearance using a straight edge and a feeler gauge.

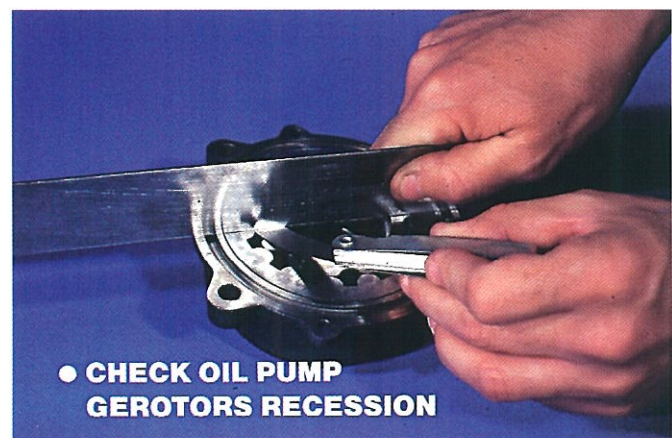

● CHECK OIL PUMP GEROTORS RECESSON

199

UNIQUE SERVICE PROCEDURES



200

FRONT SEAL/OIL PUMP

- Removal of the wear sleeve from damper without impacting the balance is accomplished by using the proper tool, #T94T-6379-AH1.



201



202

FRONT SEAL/OIL PUMP

- Install the collars and the screw plate to remove the sleeve.

UNIQUE SERVICE PROCEDURES

FRONT SEAL/OIL PUMP

- After surrounding the collars, turn the bolt with a wrench to remove the wear sleeve.



203



204

FRONT SEAL/OIL PUMP

- Wear sleeve removed.



205

FRONT SEAL/OIL PUMP

- Prior to installing front seal wear sleeve, LOCTITE® No. 271 should be applied to the wear sleeve inside diameter to prevent oil migration.

UNIQUE SERVICE PROCEDURES



206

FRONT SEAL/OIL PUMP

- Install wear sleeve using the correct tool, #T94T-6379-AH2.

FRONT SEAL/OIL PUMP

- The front cover is aluminum so it is very critical to properly tighten the oil pump mounting bolts to the proper torque. Specifications are in the service manual.

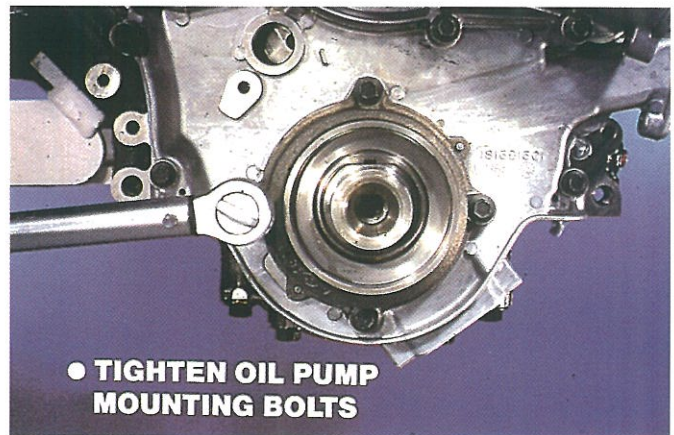

207



208

FRONT SEAL/OIL PUMP

- Install front seal making sure hydraulic sealant, LOCTITE® No. 271 has been applied to the seal outside diameter.

UNIQUE SERVICE PROCEDURES

FRONT SEAL/OIL PUMP

- Install front seal until the tool, #T94T-6700-AH, bottoms against the housing.

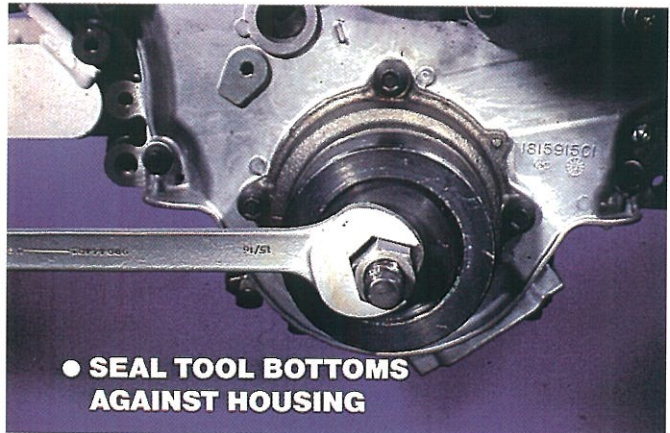

- SEAL TOOL BOTTOMS AGAINST HOUSING

209

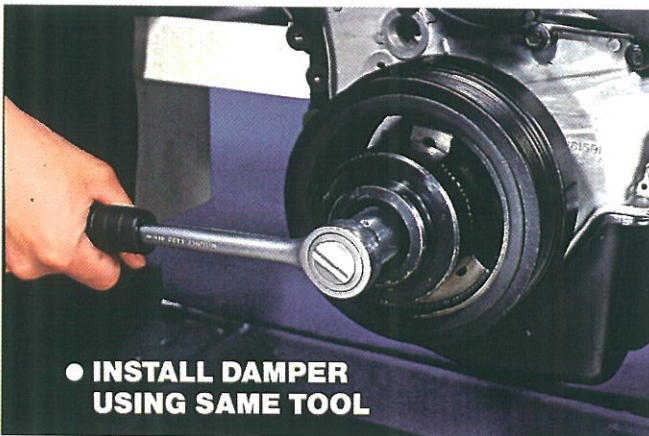

- INSTALL DAMPER USING SAME TOOL

210

FRONT SEAL/OIL PUMP

- Install damper using same tool as the front seal, driving with its opposite side.

REAR SEAL

- Remove the five bolts which secure the seal carrier to the rear cover.



- REMOVE RETAINING BOLTS

211

UNIQUE SERVICE PROCEDURES

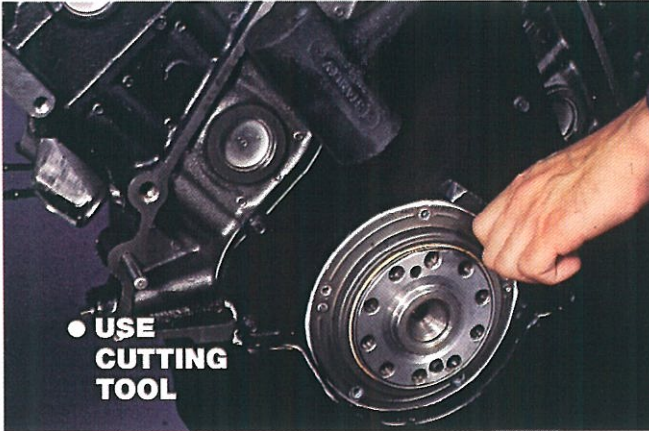

212

REAR SEAL

- Using a cutting tool, Rotunda #163-000DE, cut the sealant securing the seal retainer to the rear plate.

REAR SEAL

- Once the sealant has been cut, remove the rear seal.
- NOTE: A wear sleeve is used in production.



213

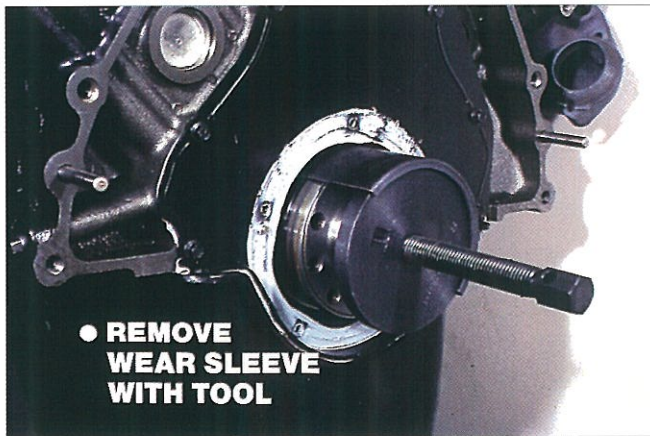

214

REAR SEAL

- Removing wear sleeve using tool, #T94T-6701-AH1.

UNIQUE SERVICE PROCEDURES

REAR SEAL

- Removing wear sleeve using the proper tool prevents damage to the rear cover and crankshaft flange.



● REMOVE WEAR SLEEVE WITH TOOL

215

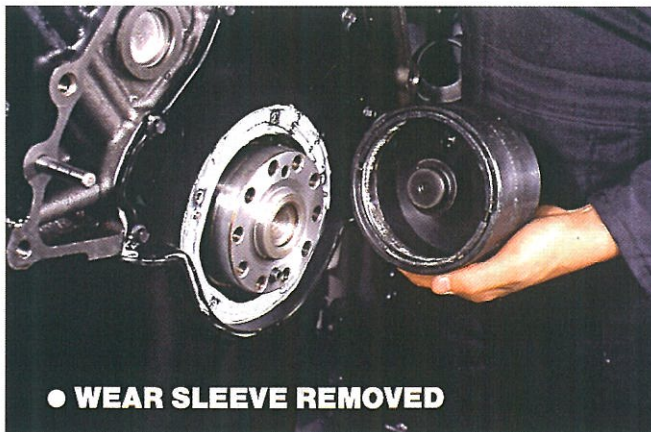

● WEAR SLEEVE REMOVED

216

REAR SEAL

- Use of the proper tool prevents damage to the crankshaft flange.



● INSTALL WEAR SLEEVE WITH TOOL

217

REAR SEAL

- To install the crankshaft rear seal wear sleeve correctly, use tool #T94T-6701-AH4.
- Seal and wear ring are to be installed as an assembly and should not be separated to avoid damaging seal.

UNIQUE SERVICE PROCEDURES

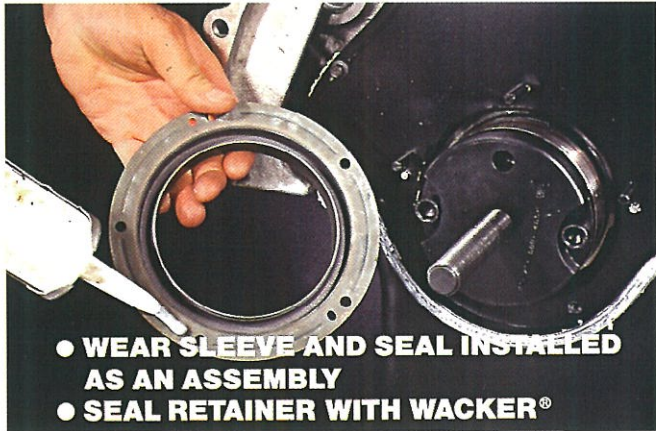

218

REAR SEAL

- Install wear sleeve and seal by aligning dowels with correct holes in seal retainer.
- Tool will bottom against crankshaft flange when wear sleeve is positioned correctly.

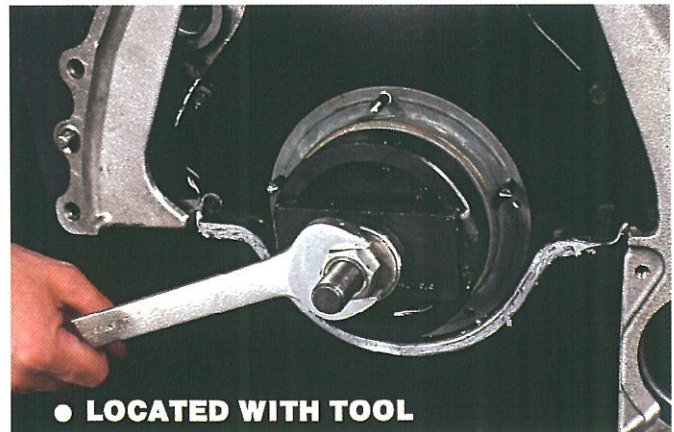

219

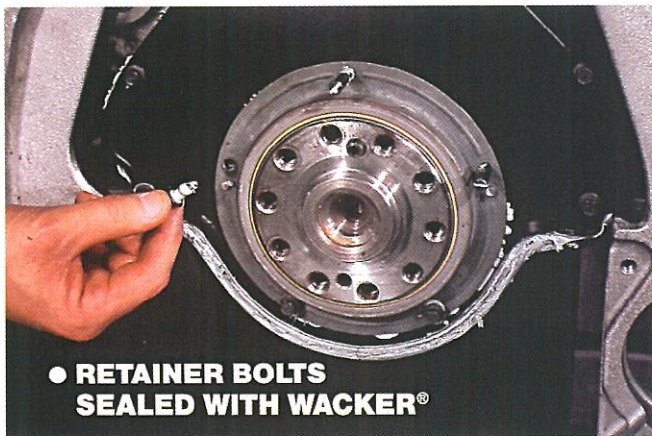

220

REAR SEAL

- Apply a bead of LOCTITE® No. 515 sealant to the outside diameter of the crankshaft flange.
- Wear sleeve and seal are installed as an assembly with Wacker® T-95 RTV sealant on retainer.
- Sealant must be applied around all bolt and dowel holes to seal properly.

REAR SEAL

- Apply Wacker® T-95 RTV sealant to the five seal retainer bolts.
- The 2 lower bolts penetrate the rear cover and require sealant.

UNIQUE SERVICE PROCEDURES

OIL PAN

- Remove oil pan using a cutting tool.



221



222

OIL PAN

- Oil pick up tube removal is required to remove front cover. The oil pick up tube is sealed to the front cover by an "O"-ring.

WATER PUMP AND FRONT COVER

- The water pump is sealed to the front cover by an "O"-ring.

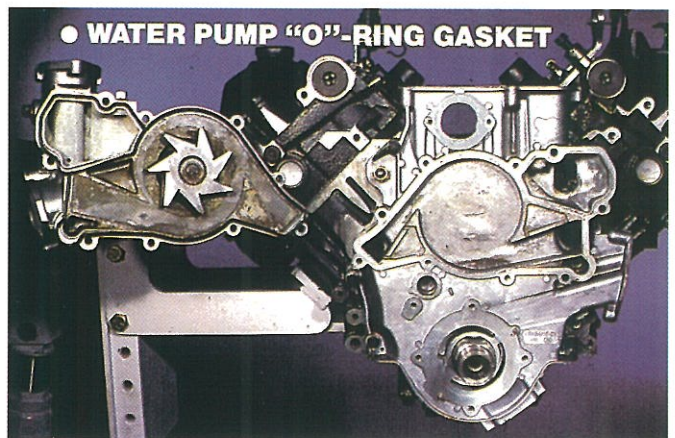

223

UNIQUE SERVICE PROCEDURES

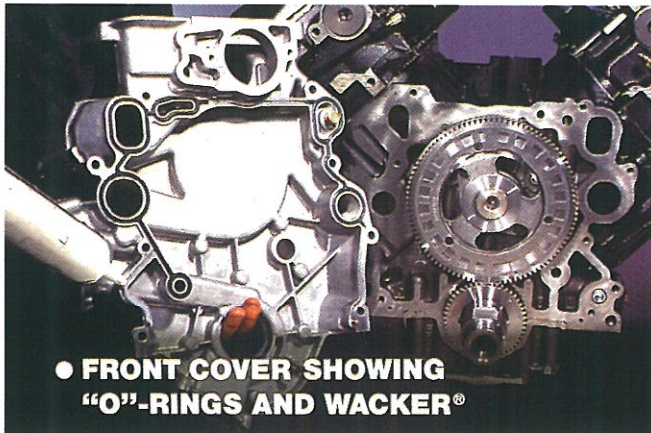

● FRONT COVER SHOWING
"O"-RINGS AND WACKER®

224

WATER PUMP AND FRONT COVER

- Four water-pump bolts go through the front cover into the crankcase.



● FOUR WATER
PUMP BOLTS
THREADED INTO
CRANKCASE

225

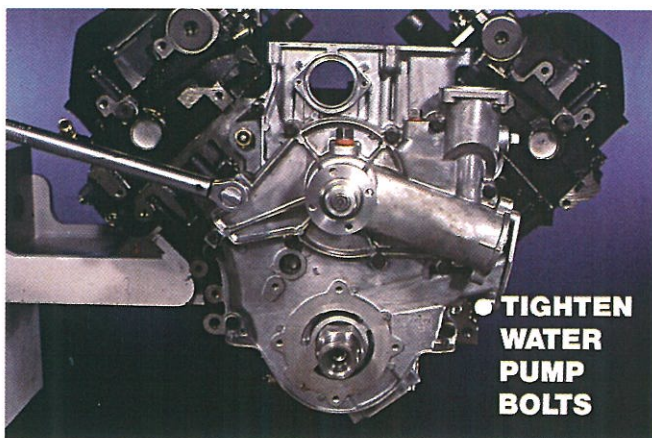

● TIGHTEN
WATER
PUMP
BOLTS

226

WATER PUMP AND FRONT COVER

- Tighten the water pump bolts to the specified torque, keeping in mind the front cover is aluminum.

UNIQUE SERVICE PROCEDURES

WATER PUMP AND FRONT COVER

- Whenever re-installing the oil pick up tube, always install a new "O"-ring.
- Tighten oil pick up tube to front cover before tightening main bearing support.

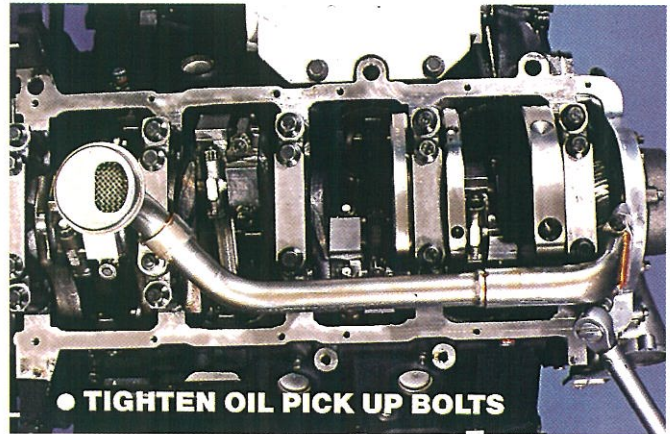

227

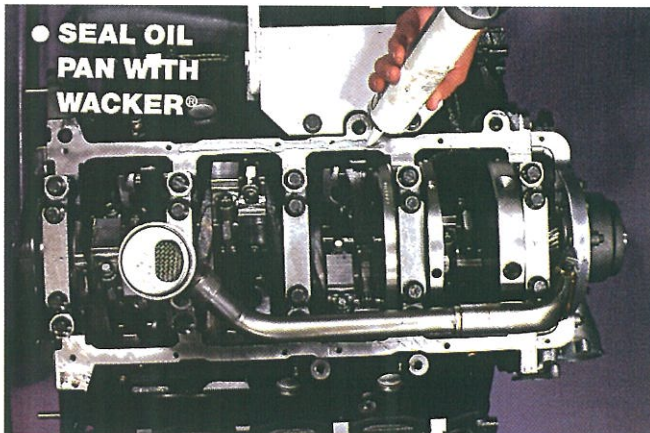

228

OIL PAN

- Apply Wacker® T-95 RTV sealant to seal the oil pan to the crankcase.
- Inside of bolt holes.
- Heavier at front and rear.

GLOSSARY

APS Accelerator Position Sensor

A potentiometer style sensor that indicates the operator's pedal position.

Actuator

A device which delivers motion in response to an electrical signal.

Analog

A continuously variable voltage.

BARO Barometric Pressure Sensor

An analog device which indicates atmospheric pressure which allows the PCM to compensate for altitude. A BARO sensor has three connections, signal return (gnd), BARO signal, and Vref.

CMP Camshaft Position Sensor

A Hall effect sensor used to indicate engine speed and camshaft position. Speed is indicated by the number of vanes counted per revolution. Camshaft position is indicated by a single narrow vane which indicates #1 cylinder position or a wide vane in dual sync application that indicates #6 cylinder.

DVOM Digital Volt Ohm Meter

A meter that uses a digital display to indicate a measured value. Preferred for use on microprocessor systems because a DVOM has a very high internal impedance and will not load down the circuit being measured.

EBP Exhaust Back Pressure Regulator

A pulse width modulated controlled butterfly valve mounted on the exhaust side of the turbocharger used to create exhaust back pressure to insure faster engine and cab warmup.

EBP Exhaust Back Pressure Sensor

A transducer style sensor used to indicate exhaust back pressure.

EOT Engine Oil Temperature

A thermistor type sensor which indicates engine temperature.

GPR Glow Plug Relay

Relay which supplies power to the glow plugs.

Hall Effect Sensor

A Hall Effect sensor generates a digital on/off signal

that indicates speed and also engine timing. The signal is created by a switching action caused by the passing of a vane thru a positive and negative voltage potential. When the vane is between this potential, a signal is created. When the gap in between this potential is open, no signal is generated. The wider the vane the longer the duty cycle of the signal, the narrower the vane the shorter the duty cycle of the signal. A narrow vane is used to indicate the position of #1 cylinder and a wide vane to indicate the position of #6 cylinder. A Hall Effect sensor has three connections: ground, Vref, signal.

IAT Intake Air Temperature Sensor

A thermistor style sensor used to indicate air temperature.

ICP Injector Control Pressure

A transducer style sensor used to indicate gallery pressure.

IPR Injection Control Regulator

controls injection oil pressure. An electrical signal to a solenoid creates a magnetic field which applies a variable force on a poppet to control pressure. The quantity of fuel delivered to the combustion chamber is proportional to injection control pressure.

IDM Injector Drive Module

is an electronic unit which has the primary function of an electronic distributor for the injectors. It also is the power supply for the injectors. It supplies 90v@ 7 amps to the injectors.

IVS Idle Validation Switch

A on/off switch sensor that indicates when the accelerator pedal is in the idle position.

Impedence

A form of opposition to AC current flow measured in Ohms.

KOEO Key On Engine Off Test

A self-test operation that is performed with the ignition switch in the ON position with the engine off.

KOER Key On Engine Running Test

Self-test operation that is performed with the ignition switch in the ON position and the engine running.

GLOSSARY

MAP Manifold Absolute Pressure

A MAP sensor is a sensor that generates a digital frequency that indicates manifold boost pressure or vacuum. The signal is created by switching action caused by manifold pressure on a diaphragm connected to a capacitor circuit in the sensor. The digital frequency increases as pressure increases. A MAP sensor has three connections, signal return (gnd), MAP signal and Vref.

Normally Closed

refers to a switch or a solenoid that is closed when **no** control or force is acting on it.

Normally Open

Refers to a switch or a solenoid that is open when no control or force is acting on it.**PCM Powertrain Control Module**--The housing which contains the micro computer, Vref regulator, input conditioners and output drivers.

Potentiometer (Pot)

Converts a mechanical motion to a voltage value. Most often used to sense the position of a component. This sensor works as a variable voltage divider. The wiper arm is mechanically connected to the component desired to be sensed. Potentiometers have three connections, Vref, Signal out and ground.

Pulse Width

The length of time an actuator, such as an injector remains energized.

Thermistor

Sensor used to determine temperature. A thermistor changes its resistance value in relation to temperature change. Increasing temperature results in decreasing resistance, decreasing temperature results in increasing resistance. The thermistor in conjunction with a current limiting resistor in the ECA forms a voltage divider that provides a voltage signal that indicates temperature. Since the top half of the voltage divider is the current limiting resistor and is internal to the ECA, a thermistor sensor only has two connections, signal return and ground.

VBAT--Battery voltage. (See VPWR)

VPWR--Battery voltage. (See VBAT)

VSS Vehicle Speed Sensor--Normally a magnetic pickup style sensor that is mounted on the tailshaft of the transmission to indicate ground speed.

**7.3 DIT
DIRECT
INJECTION
TURBOCHARGED
DIESEL ENGINE**

