



6.0L DIT *Power Stroke* Direct Injection Turbocharged Diesel Engine

2003.25
"F" Series
Super Duty

Features Descriptions Unique
Service Procedures and
General Diagnostics



FORWARD

This publication is intended to provide technicians and service personnel with an overview of technical advancements in the 6.0L *POWER STROKE* Diesel Engine. The information contained in this publication will supplement information contained in available service literature.

IMPORTANT SAFETY NOTICE

Appropriate service methods and proper repair procedures are essential for the safe, reliable operation of all motor vehicles, as well as, the personal safety of the individual performing the work. This manual provides general directions for accomplishing service repair work with tested, effective techniques. Following the directions will assure reliability. There are numerous variations in the procedures; techniques, tools, parts for servicing vehicles and the skill of the individual doing the work. This manual cannot possibly anticipate all such variations and provide advice or cautions as to each. Accordingly, anyone who departs from the instructions provided in this manual must first establish that they do not compromise their personal safety or the vehicle integrity by their choice of methods, tools or parts.

The following list contains some general **WARNINGS** that you should follow when you work on a vehicle.

Always wear safety glasses for eye protection.

Use safety stands whenever a procedure requires you to be under the vehicle.

Be sure that the ignition switch is always in the **OFF** position, unless otherwise required by the procedure.

Never perform any service to the engine with the air cleaner removed and the engine running unless a turbocharger compressor inlet shield is installed.

Set the parking brake when working on the vehicle. If you have an automatic transmission, set it in **PARK** unless instructed otherwise for a specific service operation. If you have a manual transmission, it should be in **REVERSE** (engine OFF) or **NEUTRAL** (engine ON) unless instructed otherwise for a specific service operation.

Operate the engine only in a well-ventilated area to avoid the danger of carbon monoxide.

Keep yourself and your clothing away from moving parts when the engine is running, especially the fan, belts, and the turbocharger compressor.

To prevent serious burns, avoid contact with hot metal parts such as the radiator, turbocharger pipes, exhaust manifold, tail pipe, catalytic converter and muffler.

Do not smoke while working on the vehicle.

To avoid injury, always remove rings, watches, loose hanging jewelry, and loose clothing before beginning to work on a vehicle. Tie long hair securely behind the head.

Keep hands and other objects clear of the radiator fan blades.

**This page intentionally
left blank**

TABLE OF CONTENTS

OVERVIEW6
Features6
Horsepower & Torque6
Specifications7
Identification8
COMPONENT LOCATIONS9
Features14
COOLING SYSTEM17
System Flow17
Water Pump19
LUBRICATION SYSTEM21
System Flow21
FUEL SUPPLY SYSTEM27
System Flow27
Check Valve30
AIR MANAGEMENT SYSTEM31
System Flow31
VGT34
EGR37
FUEL MANAGEMENT SYSTEM39
High Pressure Oil System40
System Flow40
Fuel Injectors43
Stages of Injection45
ELECTRICAL COMPONENTS49
Sensors49
Actuators64
Other Electrical Components65
UNIQUE SERVICE PROCEDURES69
GENERAL DIAGNOSTICS79
APPENDIX83

**This page intentionally
left blank**

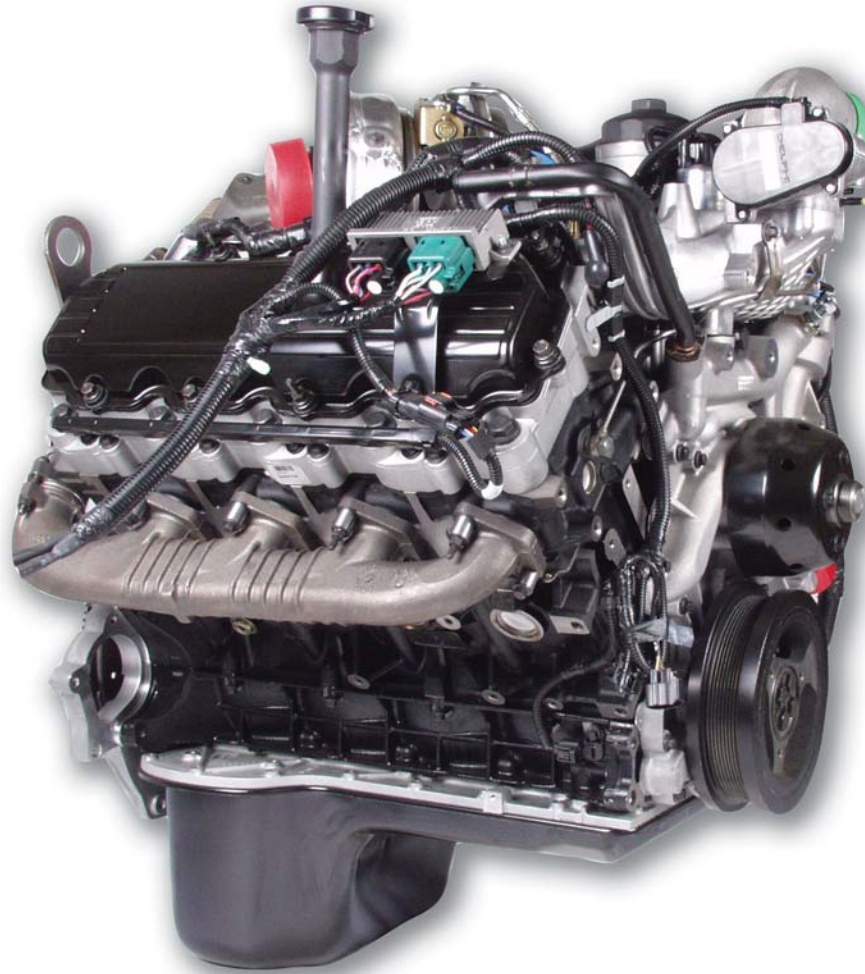

1

6.0L *Power Stroke*

**Direct Injection
Turbocharged Diesel
Engine**

6.0L POWER STROKE OVERVIEW

6.0L Power Stroke Overview

- This publication is not intended to replace the Service Manual but to introduce the 6.0L Power Stroke engine.

Engine Features

- The 6.0L Power Stroke has been designed to meet the customers' expectations of high horsepower and torque over a wide RPM range.
- The 6.0L Power Stroke has also been designed to meet the tougher emissions standards set by the government.
- Meeting the more stringent customer and regulated demands are accomplished in part by: VGT, digital injection system, 4 valves per cylinder, and dual timing system.

Horsepower & Torque

- The 6.0L Power Stroke creates 325 horsepower at 3300 RPM and 560 ft/lb of torque at 2000 RPM.
- **Note: Torque has increased and occurs at lower engine RPM than previous models.**

6.0L Power Stroke Direct Injection Turbocharged Diesel Engine Overview

- Engine Features
- Horsepower & Torque
- Engine Specifications
- Physical ID
- Labeling

2

Engine Features

- Variable Geometry Turbocharger
- Digital Fuel Injection
- 4 Valves per Cylinder
- Reusable Gaskets
- Rear Gear train
- Dual Timing System

3

Horsepower & Torque Chart

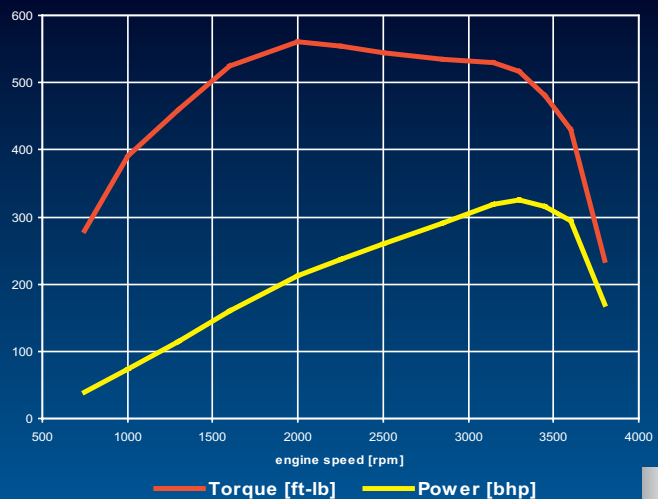

4

6.0L POWER STROKE OVERVIEW

6.0L Power Stroke Diesel Specifications

Engine Type	Diesel, 4-Cycle
Configuration	4 OHV/1 Cam-in-Crankcase-V8
Displacement	365 cu. in (6.0 L)
Bore & Stroke	3.74 X 4.134 in (95 X 105 mm)
Compression Ratio	18.0:1
Aspiration	VGT/CAC
Rated Power @ RPM	325 @ 3300 RPM
Peak Torque @ RPM	560 @ 2000 RPM
Engine Rotation, Facing Flywheel	Counter Clockwise
Combustion System	Digital Direct Injection
Total Engine Weight (auto with oil)	966 lb. (438 kg)
Coolant Flow	74.7 gal/min (282.8 L/min) @ 3300 RPM
Air Flow @ RPM	732 CFM (20.7 m ³ /min) @ 3300 RPM
Exhaust Flow @ RPM	1499 CFM (42.4 m ³ /min) @ 3300 RPM
Oil Flow @ RPM	18.5 gal/min (70 L/min) @ 3300 RPM
Cooling System Capacity (engine only)	11.1 qts. (10.5 L)
Lube-System Capacity (including filter)	15 qts. (14.2 L)
Firing Order	1-2-7-3-4-5-6-8

5

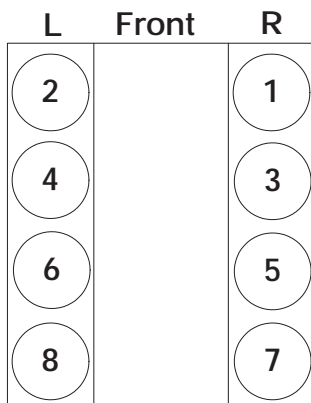

Specifications

- The 6.0L *Power Stroke* engine is a totally new engine design that will provide improved performance, and cleaner emissions.
- The cylinders of the 6.0L *Power Stroke* are numbered from the front on the right side 1,3,5,7 and from the front on the left side 2,4,6,8.

6.0L POWER STROKE OVERVIEW

Engine Serial Number

- The engine serial number is located on the left rear corner of the crankcase.
- The engine serial number identifies the engine family, build location, and the sequential build number.
- 6.0 - is the engine family identifier.
- HU2U - is a manufacturing designator.
- 6000173 - is a sequential build number.

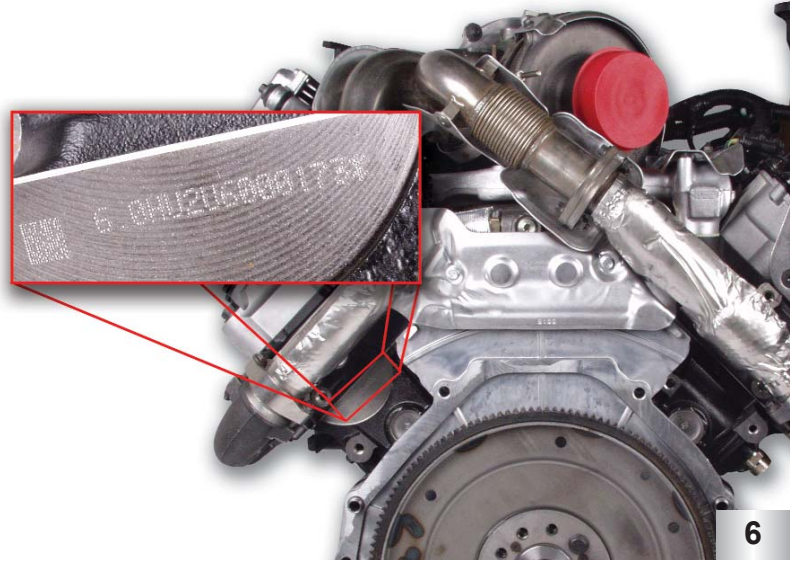

6

Serial Number/FICM Calibration Label

- Another location for the engine serial number is a label on the FICM (Fuel Injection Control Module).
- The engine serial number label also states the build location and build date of the engine.
- Another label on the FICM is the part number and the FICM calibration label.



7

Emissions Label

- States the horsepower rating for the engine, programmed in the powertrain control module (PCM).
- Depicts where the engine meets or exceeds emission standards.
- Shows the engine displacement.
- Is affixed to the right hand valve cover behind the glow plug control module.



8

COMPONENT LOCATIONS

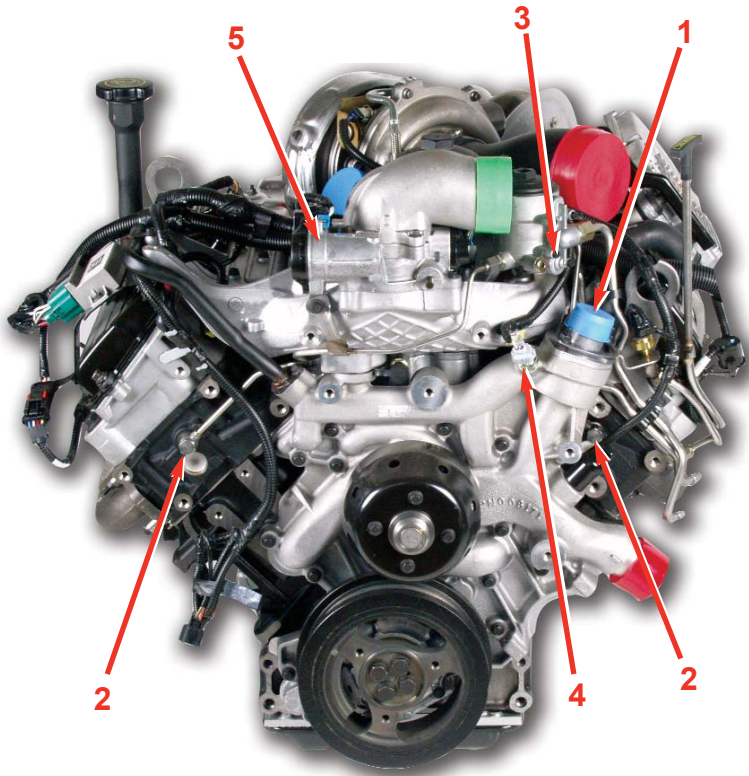

9

Front of Engine

- 1) Thermostat
- 2) Fuel Inlets on Cylinder Heads
- 3) Fuel Pressure Regulator
- 4) ECT Sensor
- 5) EGR Throttle Actuator (If Equipped)

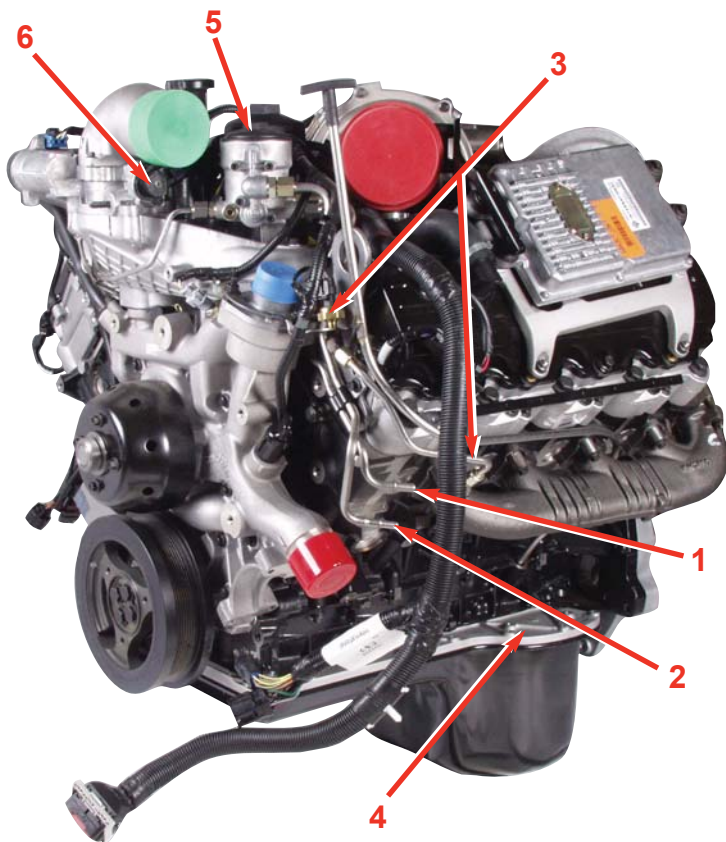

10

Left Front of Engine

- 1) Fuel Supply
- 2) Fuel Return
- 3) EBP Sensor and Tube
- 4) Upper Oil Pan
- 5) Secondary Fuel Filter
- 6) EGR Throttle Position Sensor (If Equipped)

COMPONENT LOCATIONS

Left of Engine

- 1) FICM
- 2) CMP Sensor
- 3) Oil Level Gauge
- 4) Crankcase Ventilation

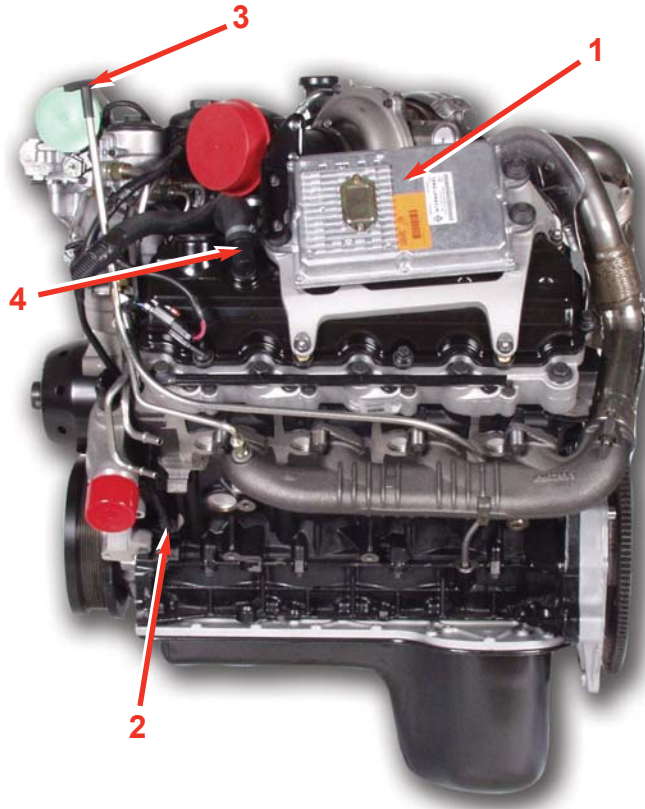

11

Left Rear of Engine

- 1) Rocker Arm Carrier
- 2) Bed Plate
- 3) Glow Plug Buss Bar

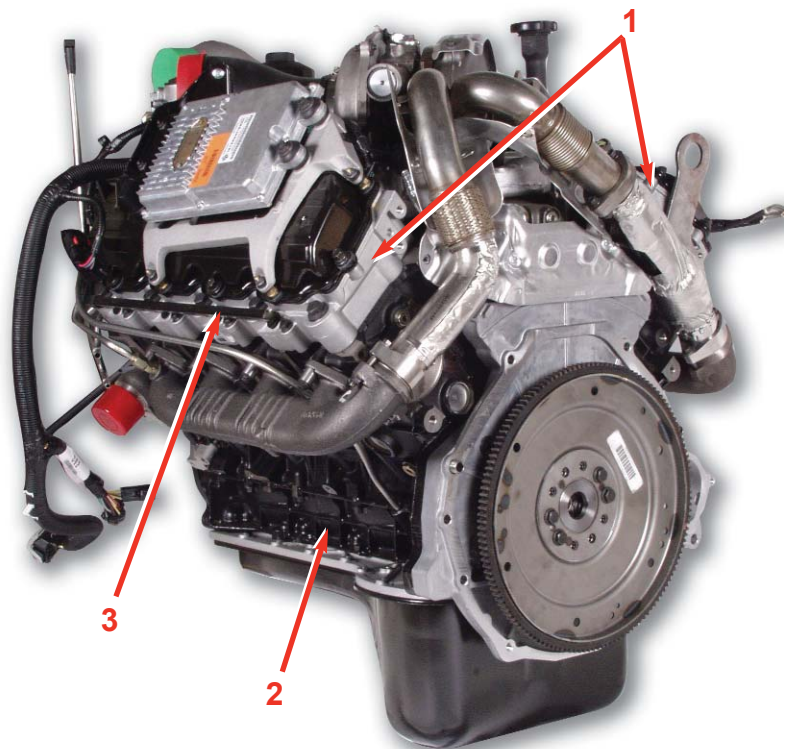

12

COMPONENT LOCATIONS

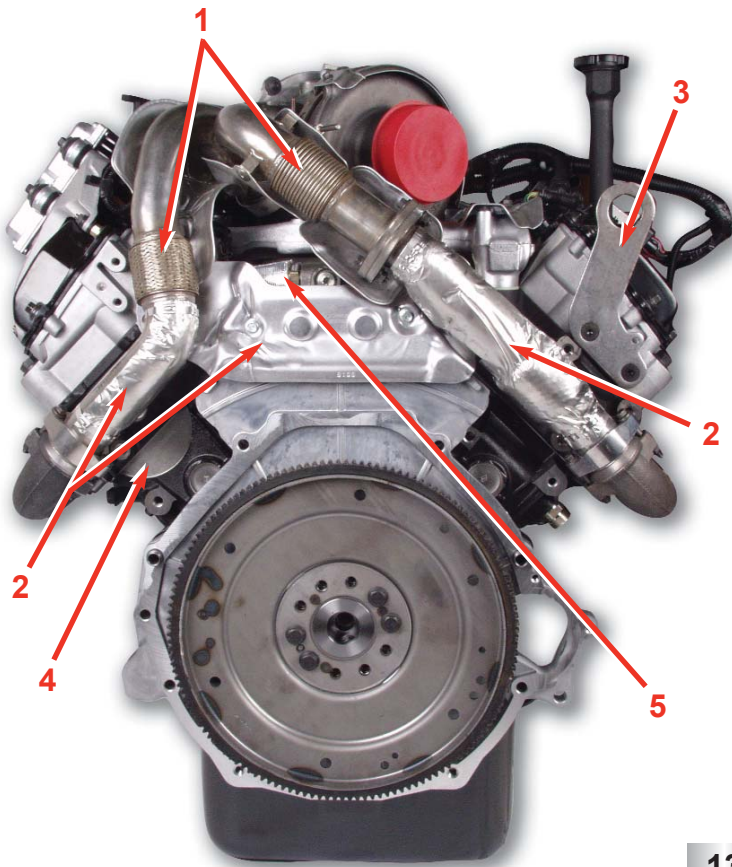

13

Rear of Engine

- 1) Exhaust Expansion Joints
- 2) Heat Shields
- 3) Lifting "Eye"
- 4) Serial Number
- 5) ICP Sensor & IPR (Behind ICP)

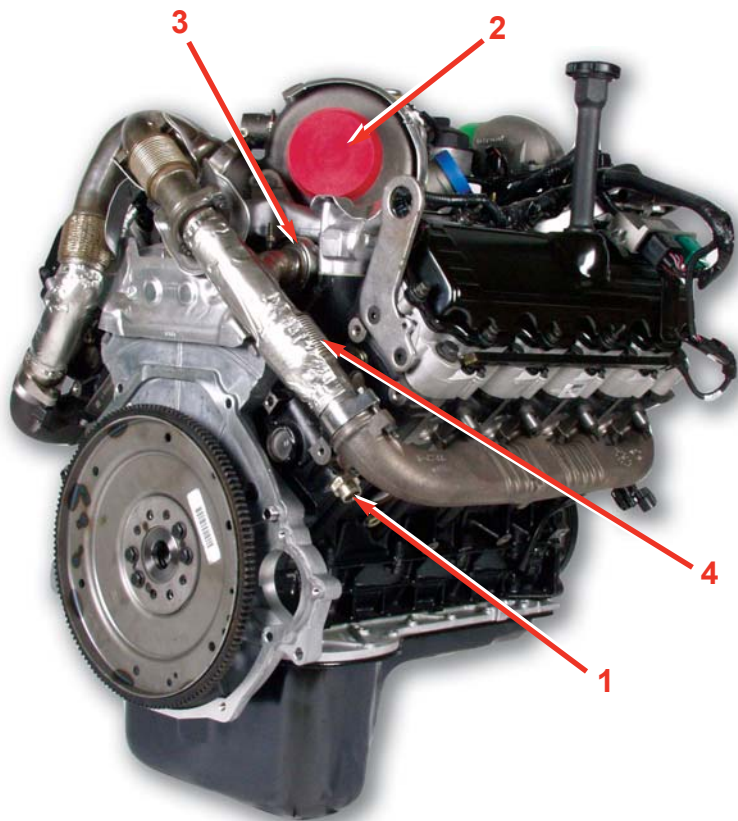

14

Right Rear of Engine

- 1) Block Heater
- 2) Turbine Outlet
- 3) Exhaust Connection to EGR Cooler
- 4) Exhaust Expansion Joint

COMPONENT LOCATIONS

Right Side of Engine

- 1) CKP Sensor
- 2) Glow Plug Control Module

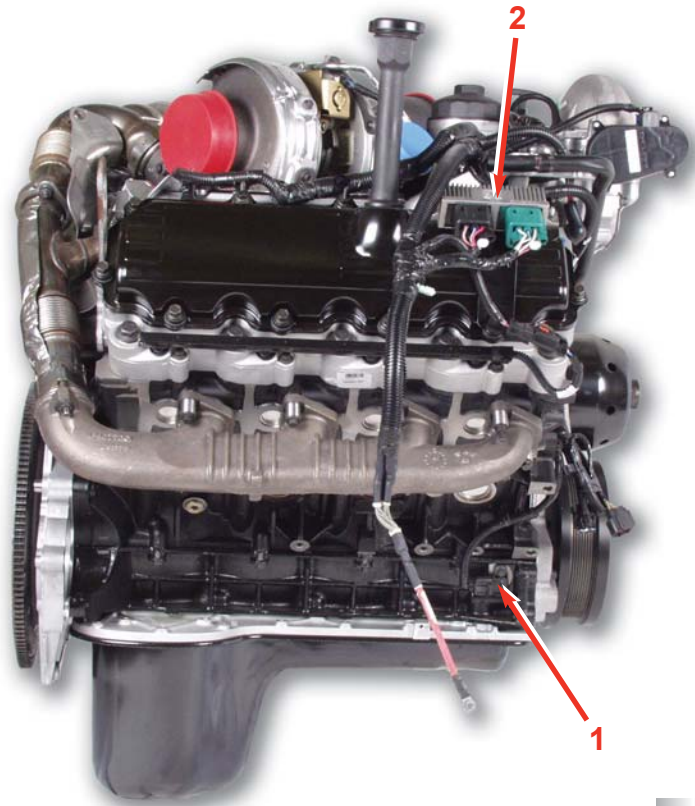

15

Right Front of Engine

- 1) Heater Return
- 2) EGR Throttle Actuator

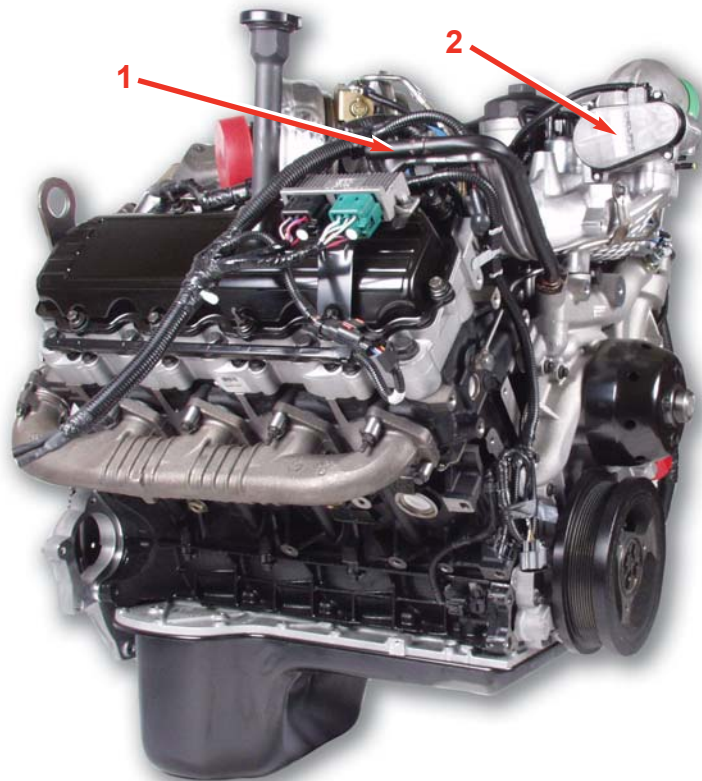

16

COMPONENT LOCATIONS

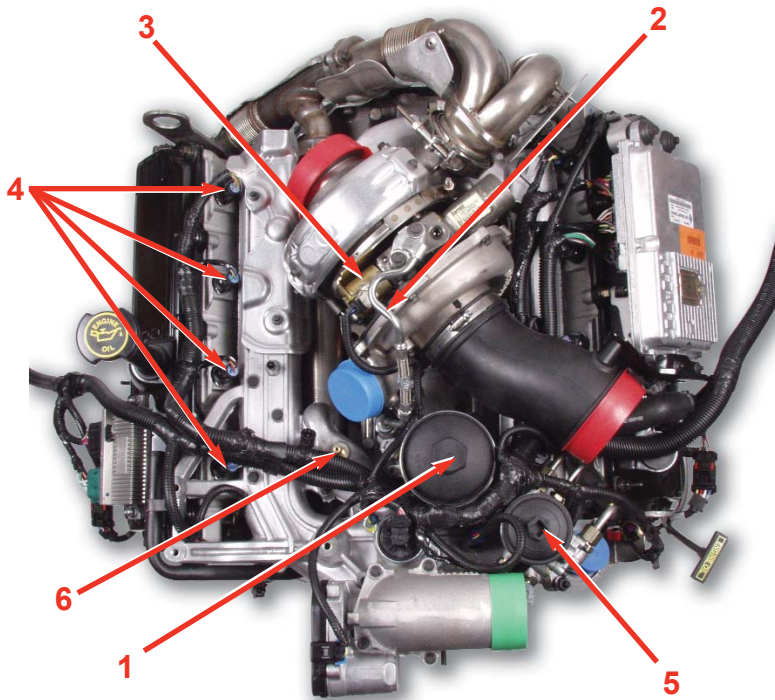

17

Top of Engine

- 1) Oil Filter
- 2) Turbocharger Oil Supply Line
- 3) EVRT/VGT Control Valve
- 4) Injector Connectors
- 5) Secondary Fuel Filter
- 6) EGR Cooler Coolant Deaeration Port

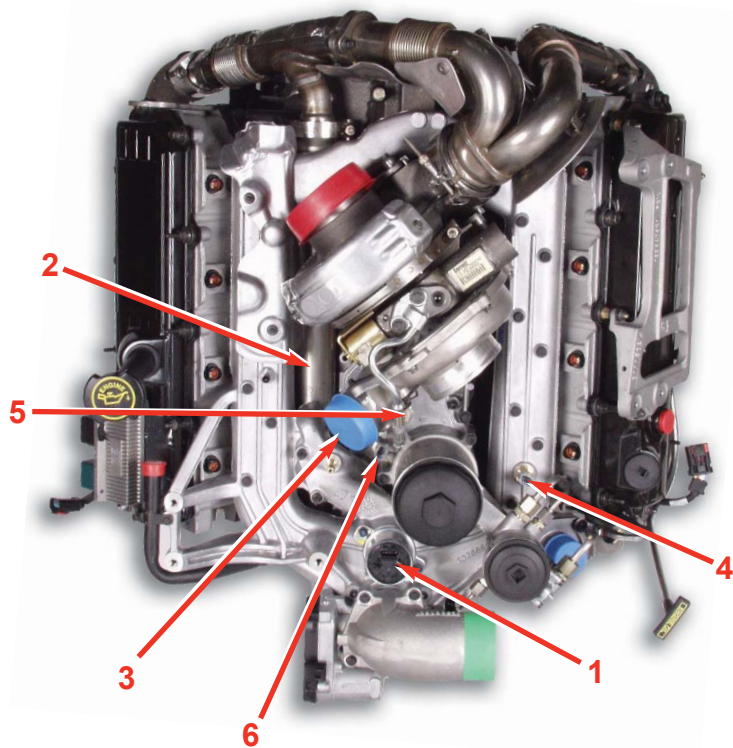

18

Top of Engine

- 1) EGR Valve
- 2) EGR Cooler
- 3) Turbocharger Compressor Outlet
- 4) IAT2 Sensor
- 5) EOP Switch
- 6) EOT Sensor

6.0L POWER STROKE FEATURES

Rocker Carrier

- The aluminum rocker arm carrier is mounted on top of the cylinder head and is held in place by the cylinder head bolts.
- The rocker arm carrier provides the mounting location for all of the rocker fulcrums.
- The carrier also provides the connector pass through for the injector and glow plug.

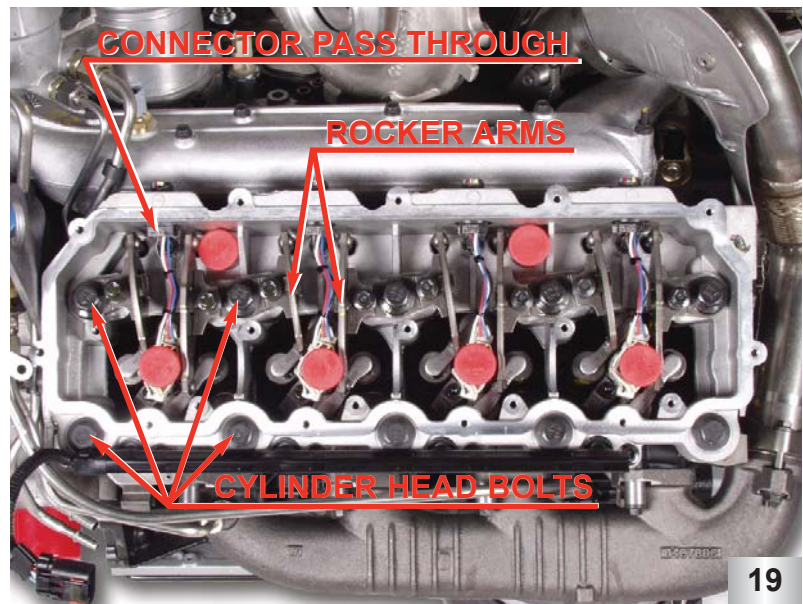

Cylinder Head

- The 6.0L *POWER STROKE* uses a four (4) valve per cylinder head design to increase air flow and efficiency.
- For identification, the exhaust valves are smaller than the intake valves.

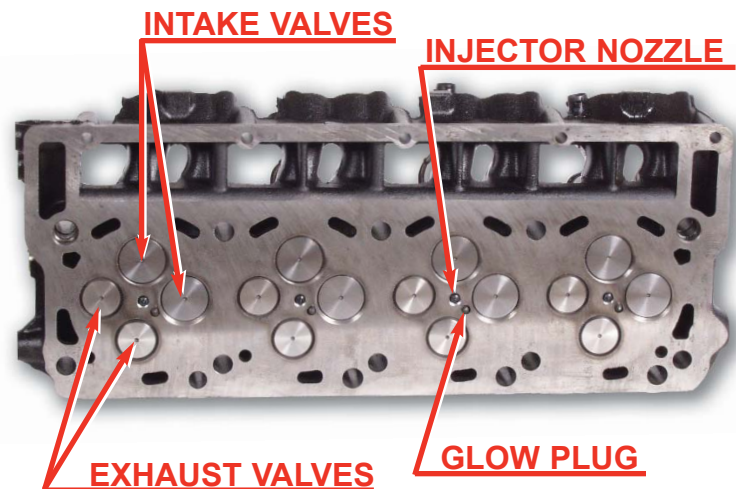

Rear Geartrain

- The geartrain for the crankshaft, camshaft, and high pressure pump are located in the rear of the engine under the rear cover.
- This allows the high pressure pump to be mounted inside the engine and also reduces geartrain noise.

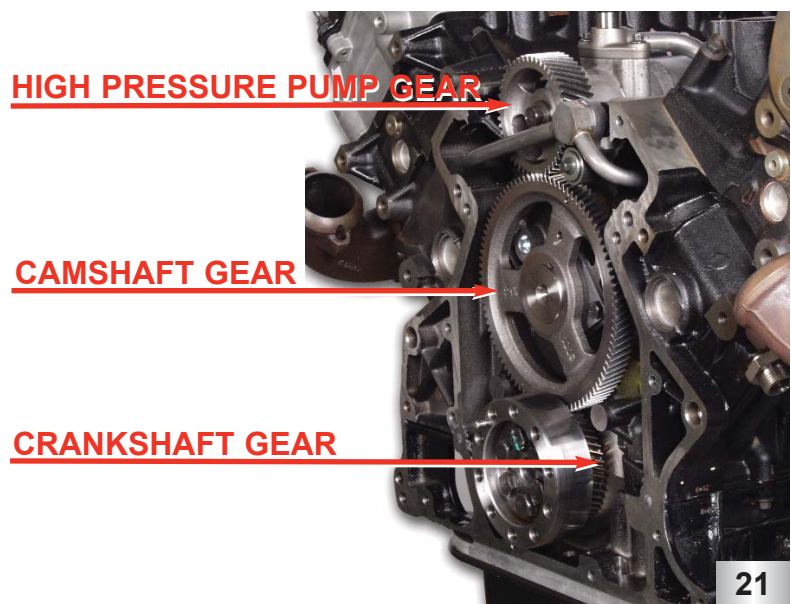

6.0L POWER STROKE FEATURES

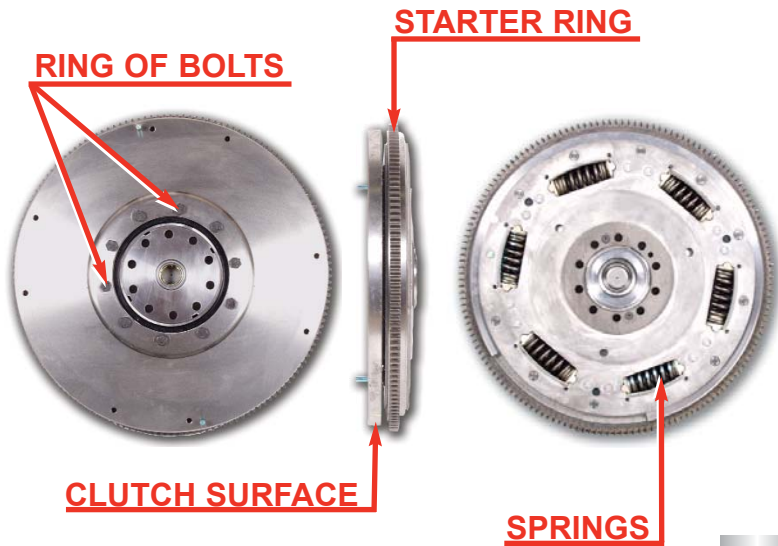

22

Dual Mass Flywheel

- The 6.0L Power Stroke uses two different flywheels for the manual transmission.
- A dual-mass flywheel is used on the F-250/350 Superduty truck.
- The dual-mass flywheel can be identified by springs located around the flywheel on the engine side.
- It can also be identified by an extra ring of bolts on the transmission side of the flywheel that holds the two masses together.
- From the side it can be identified by the separation between the clutch surface and the starter ring.

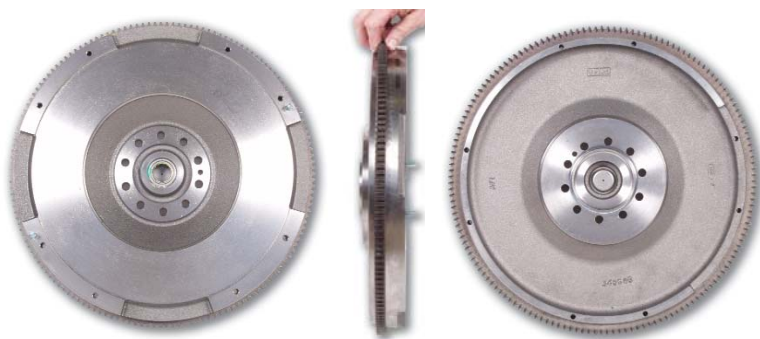

23

Single Mass Flywheel

- A single mass flywheel is used on the F-450/550 Superduty trucks.
- The single mass flywheel can be identified by the absence of the above mentioned parts and that it is machined from one solid part.

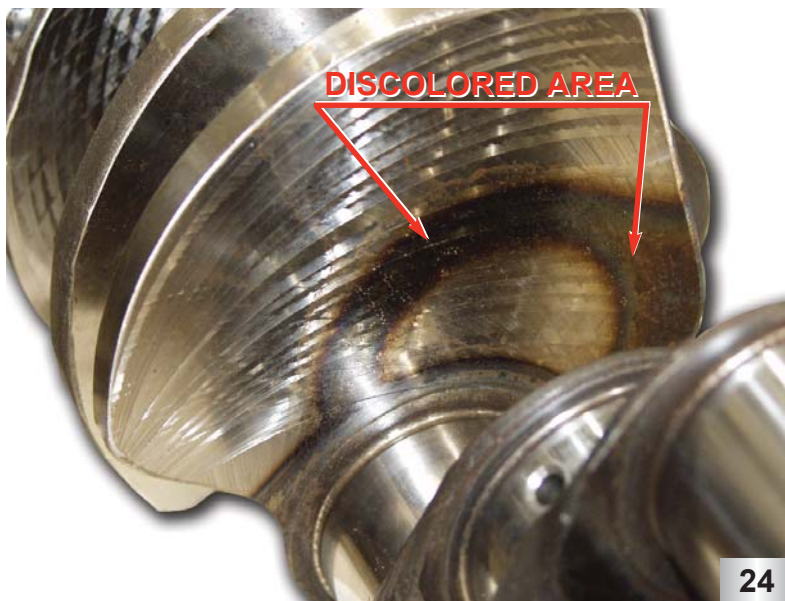

24

Normal Heat Treatment Discoloration

- The bearing surfaces on the crankshaft are induction hardened.
- During the hardening process the surrounding areas of the crankshaft discolor. This condition is normal.

**This page intentionally
left blank**

Cooling System Features

- Modular Water Pump
- Stainless Steel Injector Sleeves
- Stainless Steel Glow Plug Sleeves

25

Cooling System Features

- The modular water pump can be serviced without disconnecting radiator hoses.
- Both the glow plug sleeves and the injector sleeves are stainless steel.

Cooling System Flow

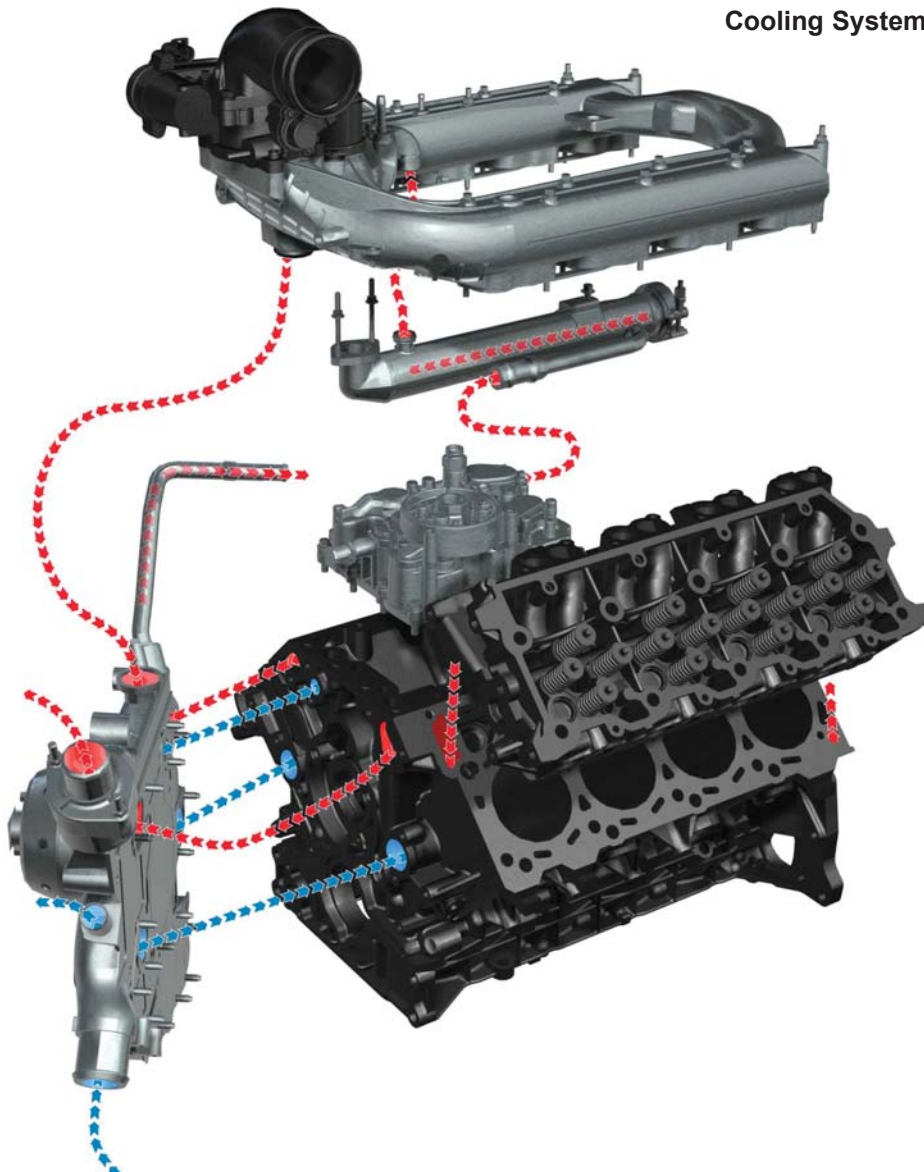

26

COOLING SYSTEM

Cooling System Flow: Front Cover

- Coolant is drawn into the inlet of the front cover and then flows from the water pump through the front cover to the crankcase.
- Coolant is also routed from the front cover into the crankcase to a passage that feeds the oil cooler.
- Return coolant is directed to the thermostat by the front cover. If the thermostat is open, coolant flows to the radiator to be cooled. If the thermostat is closed, coolant is returned to the water pump via a bypass circuit in the front cover.

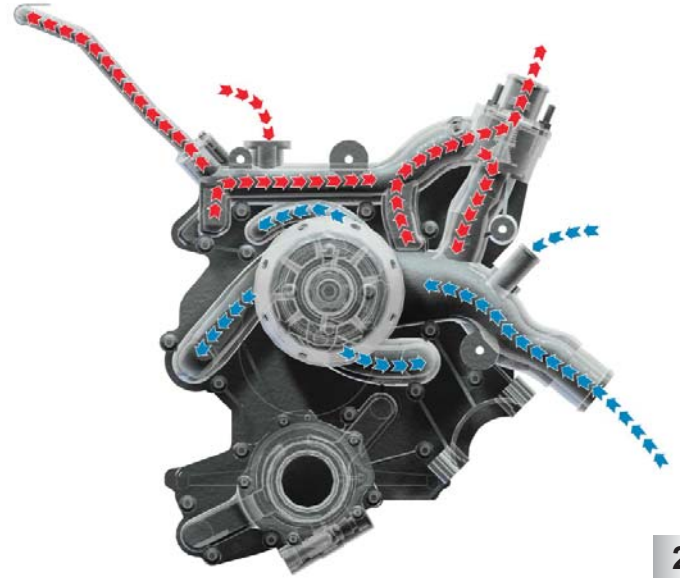

27

Cooling System Flow: Back of Front Cover

- Coolant is sealed via a silicon in metal one piece gasket and is directed out of the front cover through three (3) passages.
- Two of the passages route coolant to the crankcase to cool the cylinder walls and cylinder heads.
- The third passage routes coolant to the oil cooler via a passage in the crankcase.
- There are two passages for coolant to return from the crankcase into the front cover.

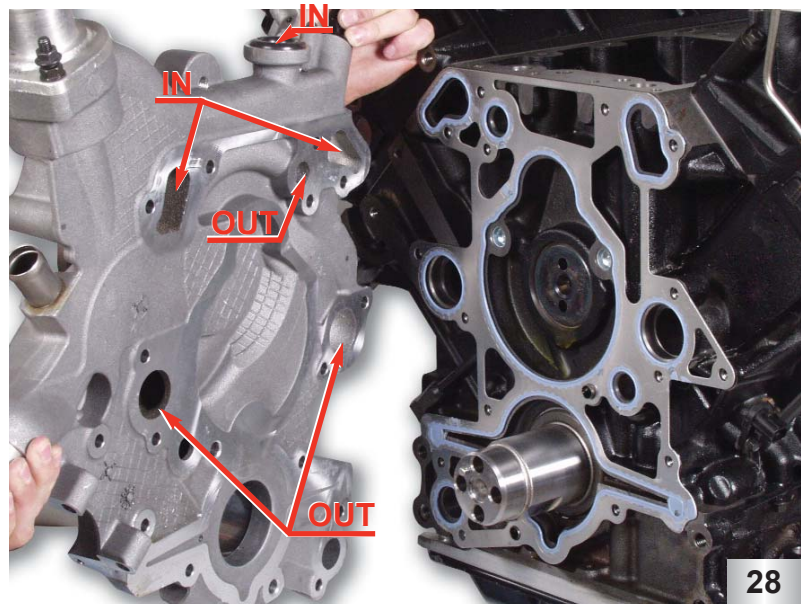

28

Cooling System Flow: Oil Cooler

- Coolant is directed out of the crankcase and into the oil filter base at the front of the engine.
- The oil filter base routes the coolant into the front of the oil cooler then toward the back of the engine.
- Once the coolant has passed through the oil cooler it is directed out of the oil filter base to the EGR cooler.
- **Note:** There are weep holes in the oil filter base that allow coolant or oil to seep out side of the filter base if an oil cooler seal is damaged.

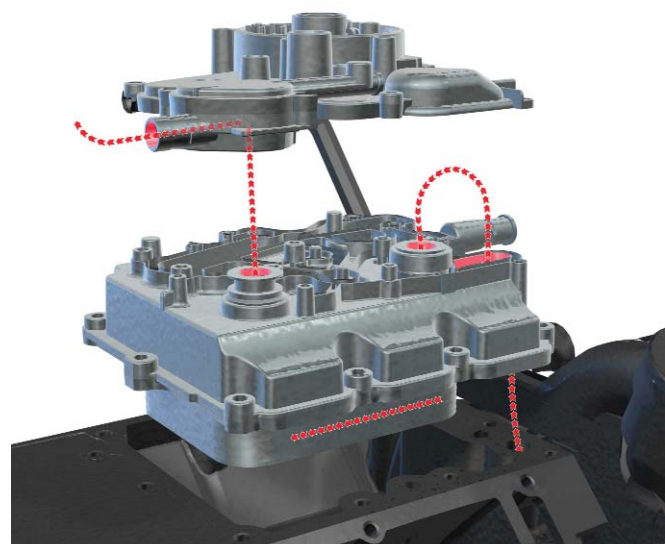

29

COOLING SYSTEM

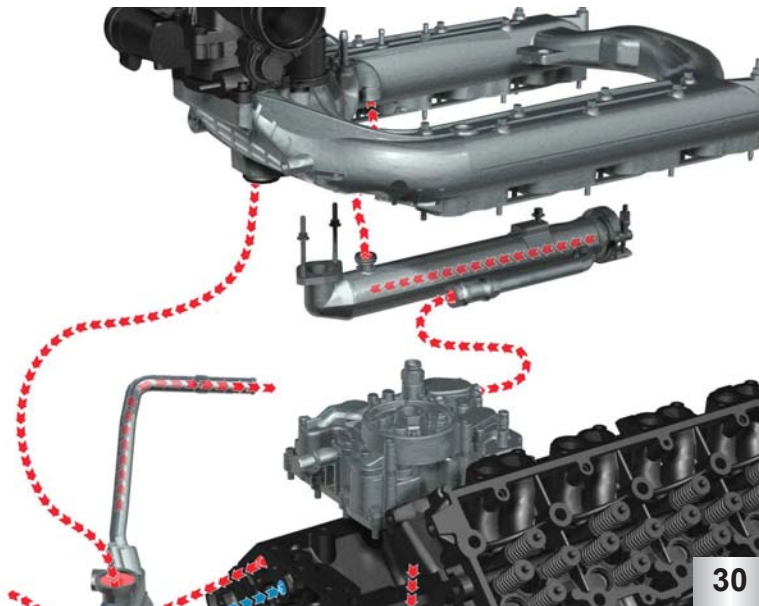

Cooling System Flow: EGR Cooler

- Coolant flows out of the filter base and into the EGR cooler through a tube that directs the coolant to the back of the EGR cooler.
- Coolant flows through the EGR cooler and removes heat from the exhaust gasses before the exhaust arrives at the EGR valve.
- Coolant exits the front of the EGR cooler and enters the coolant passage of the intake manifold. The intake manifold directs the coolant back into the front cover.

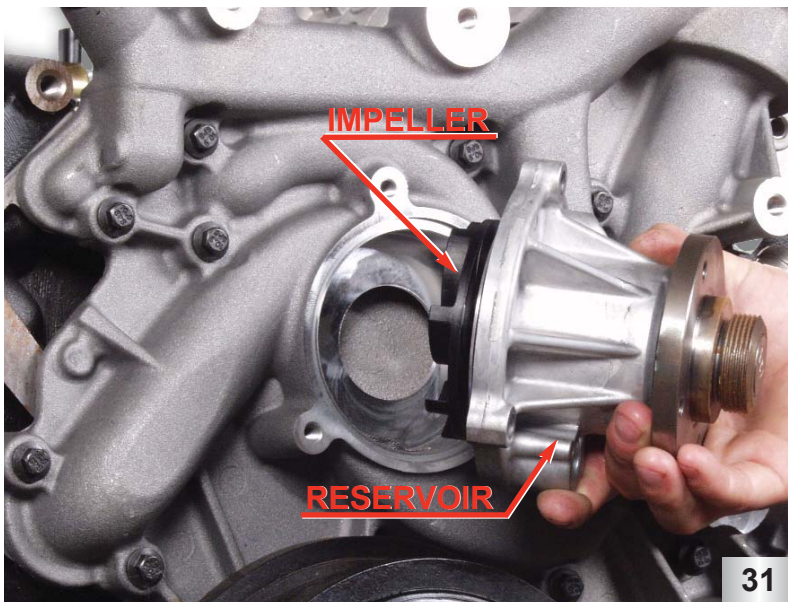

Water Pump & Front Cover

- The water pump, (hub and impeller) is mounted into the front cover which is the housing for the water pump.
- The water pump impeller pulls coolant from the center of the housing and pushes it outward.
- The water pump has a built in reservoir to catch small amounts coolant that during normal operation of the engine may seep past the seal.
- **Note: The water pump impeller may be damaged if dropped or hit by a hard object.**



Injector Sleeve

- The 6.0L *Power Stroke* uses stainless steel injector sleeves to seal coolant from the injector and to transfer heat from the injector to the coolant.
- The injector sleeve is replaceable. See unique service procedures or service manual for more details.

COOLING SYSTEM

Glow Plug Sleeve

- Glow plug sleeves are used to keep coolant from coming in direct contact with the glow plugs and to seal coolant from the combustion chamber.
- The glow plug sleeve is replaceable. See unique service procedures or the service manual for more details.



33

Coolant Recovery Bottle

- The coolant recovery bottle is located above the left valve cover.
- One of the ports on the bottle is attached to the EGR cooler deaeration port. If this port or hose is blocked, damage could occur to the EGR cooler.



34

Lubrication System Features

- Integrated Oil Cooler
- No External Oil Passages in Crankcase
- Easy Access Canister Style Oil Filter
- Front Oil Pressure Test Port
- External Oil Pressure Regulator

35

Lubrication System Features

- The 6.0L *Power Stroke* uses an oil cooler that is mounted in the valley of the engine under the oil filter. There is also an oil pressure test port in the front of the oil cooler.
- There are no oil passages located on the outside of the crankcase. This reduces the chance for oil leaks.
- The oil filter is a canister style filter mounted on the top of the engine, that drains to the oil pan during servicing.
- The gerotor oil pump and oil pressure regulator are both located in the front of the engine behind the vibration damper.

System Flow

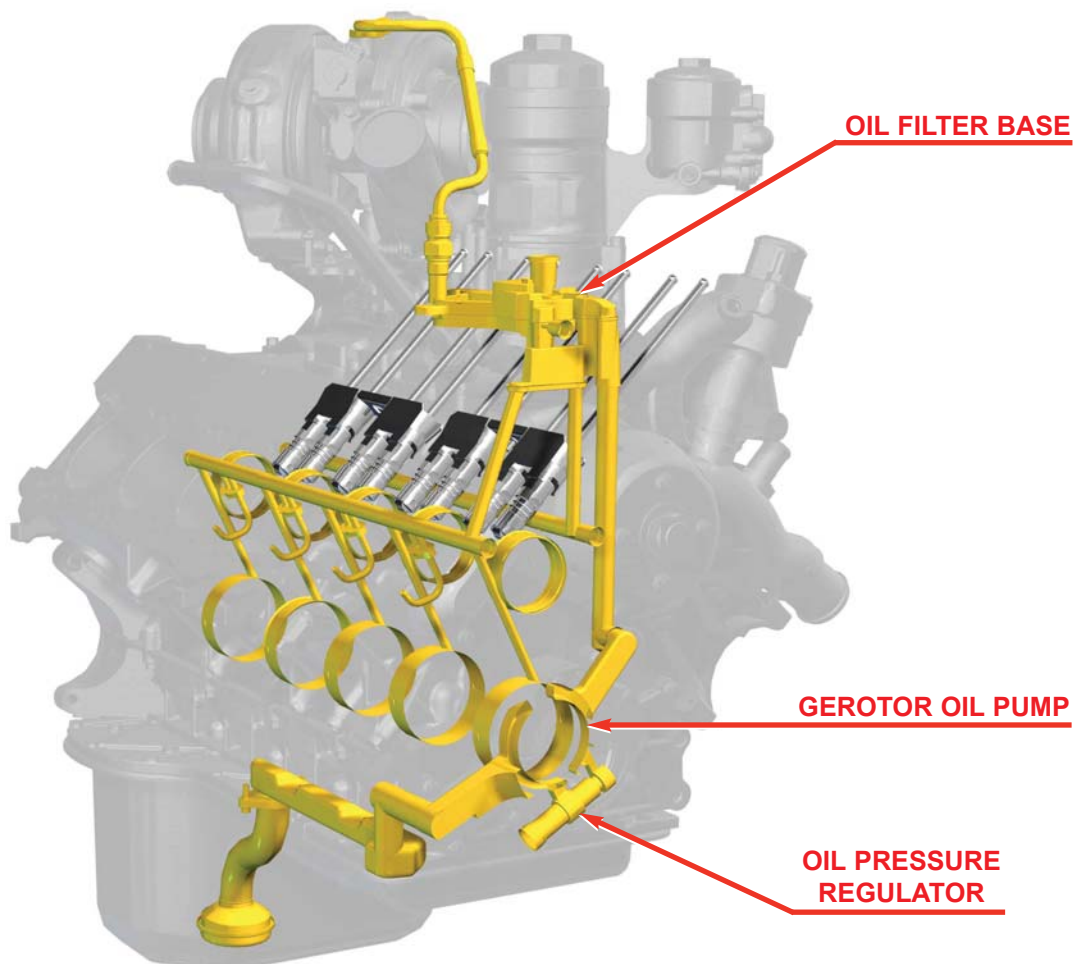

LUBRICATION SYSTEM

Lubrication System Oil Flow

- Oil is drawn from the oil pan through the pick-up tube to the gerotor oil pump.
- The oil pressure is regulated to 75 psi via the oil pressure regulator relieving excessive oil pressure to the inlet of the oil pump.
- From the oil pump, oil is directed to the oil cooler and then the to the oil filter.
- From the oil filter the oil is supplied to four (4) passages. One is to the turbocharger for lubrication and VGT control via an external line.
- The oil also is provided to the oil reservoir that supplies the high pressure oil pump.
- The two (2) other passages are to the tappet oil feed on the right and left banks. The tappet galleries also provide oil to the piston cooling jets.
- Cross drillings off of the right bank tappet gallery feed the cam bearings, then the crankshaft main bearings.
- The crankshaft has cross drillings in it to direct oil to each of connecting rod bearings.

Lube Pressure Oil System Schematic

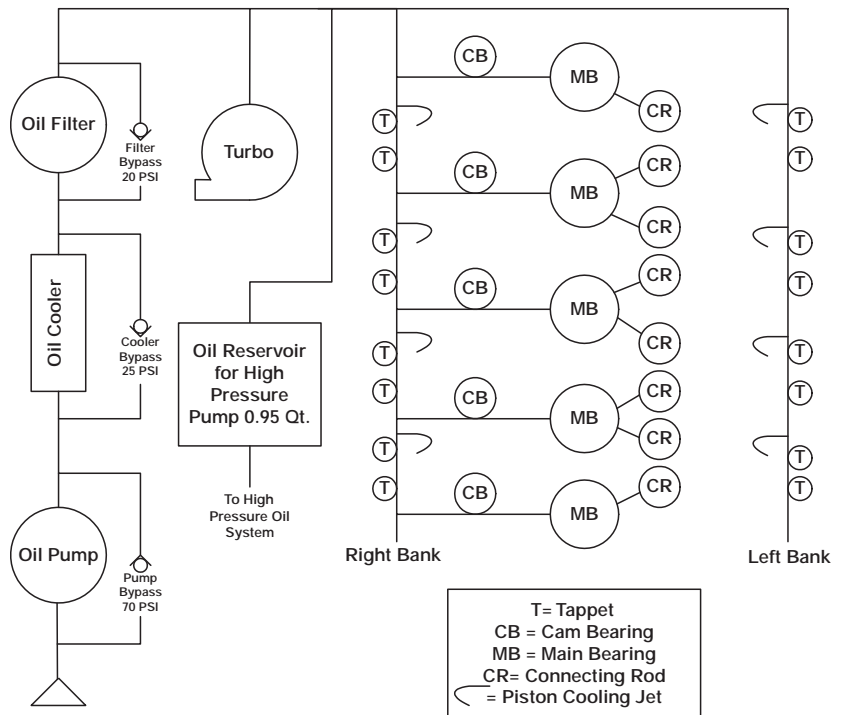

37

Oil Pan / Bed Plate

- The 6.0L *Power Stroke* uses a two piece oil pan. The lower half is wider than the bottom of the engine to increase its capacity. Due to this wider oil pan, an upper oil pan is used to adapt the lower pan to the bed plate. The upper pan also acts as an oil baffle.
- The upper pan is bolted to the bed plate. The bed plate replaces the individual main bearing caps. This one piece design results in a more rigid bearing retaining system.
- The pick-up tube is bolted to the upper pan and oil is routed through the upper pan and the bed plate to the front cover.

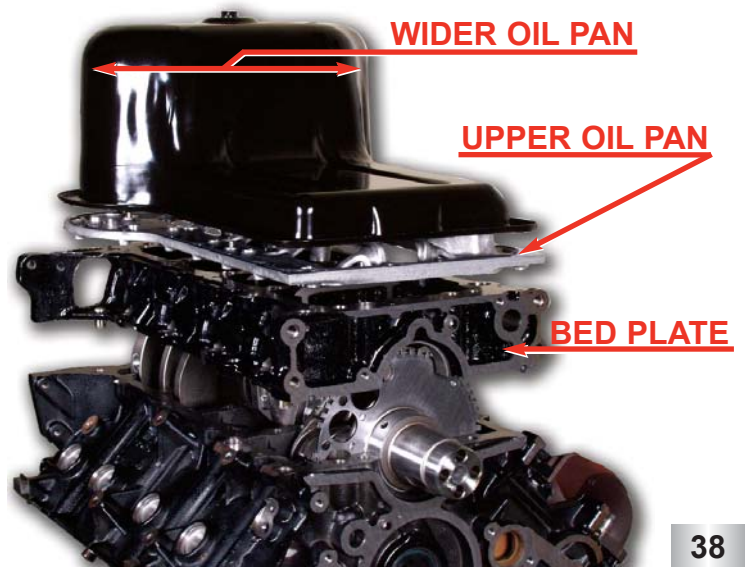

38

OIL PICK-UP TUBE



Pick-up Tube / Oil Aeration

- The pick-up tube supplies oil from the oil pan to the oil pump.
- The pick-up tube is sealed to the upper oil pan utilizing an o-ring. If the o-ring is damaged or missing, it could cause oil aeration and poor performance.
- Oil aeration is the result of air being introduced to the lubrication system on the suction side of the system or by the breakdown of the anti foaming agents in the oil. Oil aeration can cause low power and poor idle.
- A damaged or loose pick-up tube could also cause oil aeration.

OIL PUMP

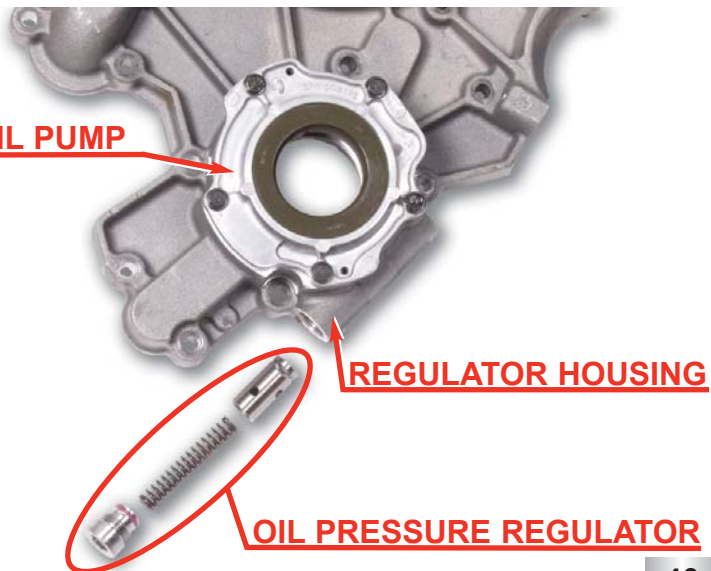

Oil Pressure Regulator

- The oil pressure regulator is located in the front cover just below the gerotor oil pump.
- The oil pressure regulator is calibrated to open at pressures above 75 psi. It should be closed below that pressure.

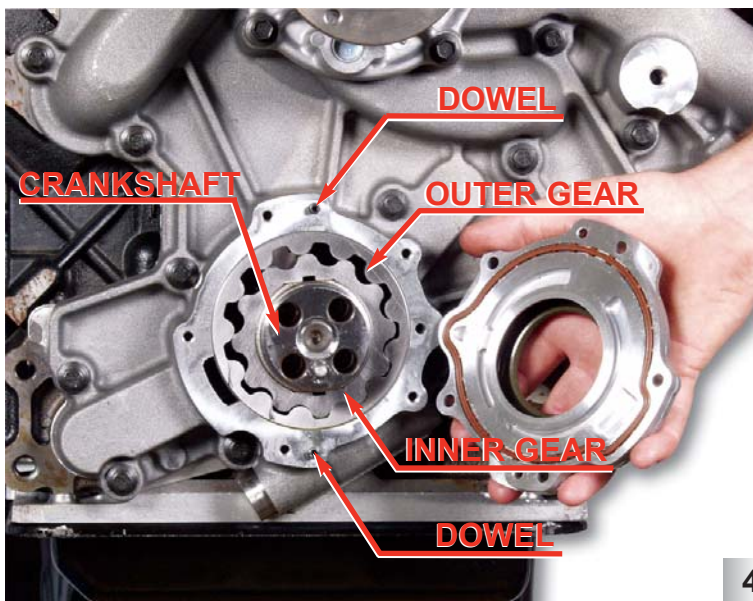

Gerotor Oil Pump

- The gerotor oil pump is driven off of the flats on the nose of the crankshaft.
- The pump is designed to flow the large volume of oil required for the 6.0L *POWER STROKE*.
- The gerotor oil pump front cover is located by two (2) dowel pins in the crankcase front cover, and is sealed by a press in place gasket.
- The outer housing for the oil pump is designed into the crankcase front cover.

LUBRICATION SYSTEM

Front Cover

- Oil flows from the crankcase to the oil pump via a passage in the back of the front cover.
- When the oil pump is turned by the crankshaft it creates oil pressure and pushes oil through one of two passages. One passage is to the oil cooler and the other is through the oil pressure regulator back to the oil pump inlet.
- All of the passages from the front cover to the crankcase are sealed with a silicon in metal, one piece gasket.

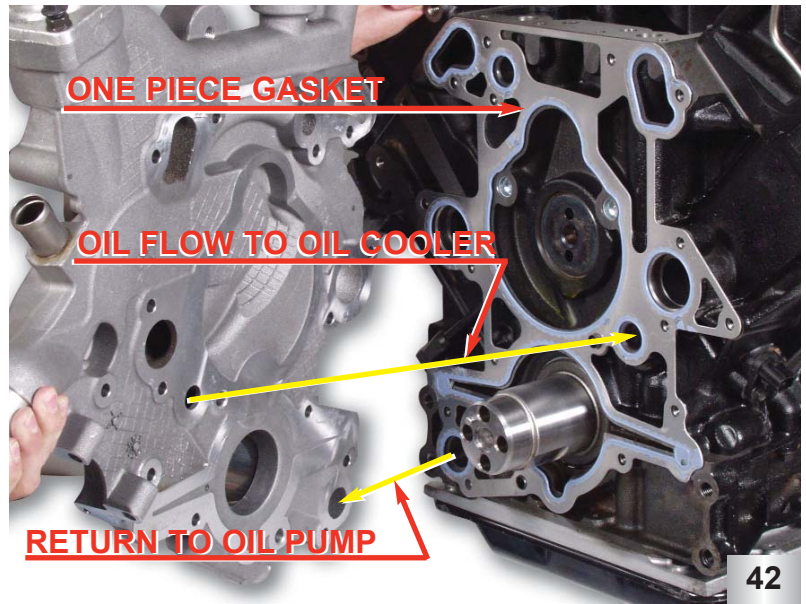

Oil Cooler

- The oil cooler is mounted in the valley of the engine and uses engine coolant to dissipate heat from the engine oil.
- Oil passes from the rear of the cooler to the front, while coolant passes from the front of the cooler to the rear.
- The coolant and oil are separated by multiple plates that create passages in the oil cooler.
- **Note: If the oil cooler is damaged it could cause contamination of the lubrication and cooling systems.**

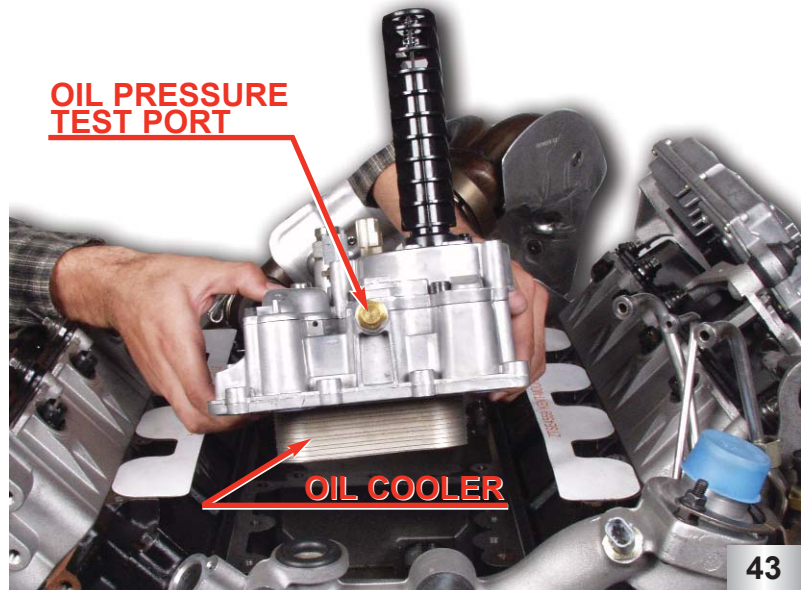

Oil Cooler Housing & Filter Base

- The oil cooler housing has passages in it to direct the flow of coolant and oil.
- Oil is routed from the front of the crankcase to the back of the housing where it enters the oil cooler. The oil passes from the rear of the oil cooler to the front of the cooler and is cooled in the process. The oil is then sent to the oil filter through the oil filter base. Filtered oil is sent to the oil reservoir for the high pressure pump and the oil passages in the crankcase.
- The coolant is directed from the front of the crankcase to the front of the oil cooler. It then passes through the oil cooler and cools the oil. As the coolant exits the rear of the oil cooler it is directed to the EGR cooler.

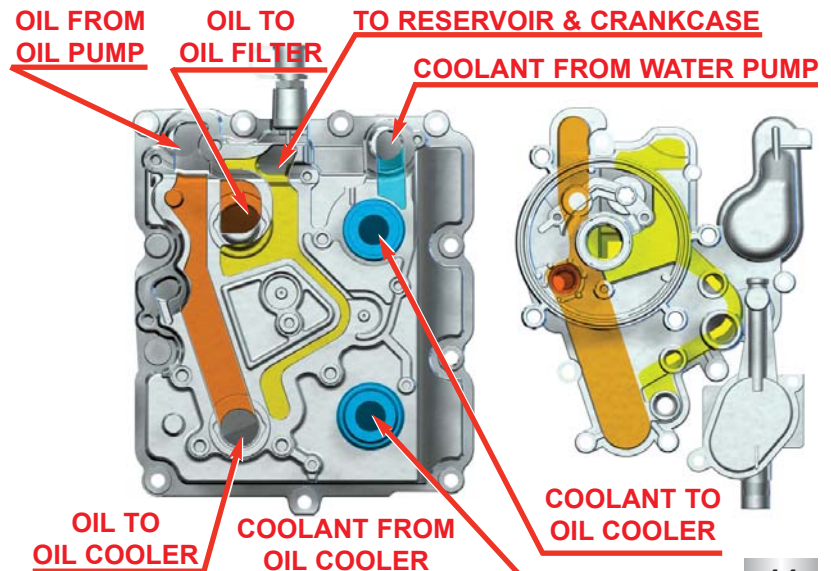

LUBRICATION SYSTEM

OIL TEMPERATURE SENSOR

OIL PRESSURE SWITCH

OIL FILTER BYPASS

OIL FILTER DRAIN

ANTI DRAIN BACK

OIL COOLER BYPASS

45

Oil Filter Base & Valves

- The oil filter base routes oil to the oil filter, engine oil pressure switch (EOP), engine oil temperature sensor (EOT), and the turbocharger oil feed.
- The oil filter base also houses the anti-drain-back check valve that keeps oil in the oil filter assembly after the engine is shut off.
- The oil cooler bypass is in the filter base and opens at a pressure differential of 25 psi.
- The oil filter bypass is in the oil filter stand pipe and opens at a pressure differential of 20 psi.
- There is an oil drain for the filter housing to drain oil from the housing during an oil change.

OIL FILTER ELEMENT

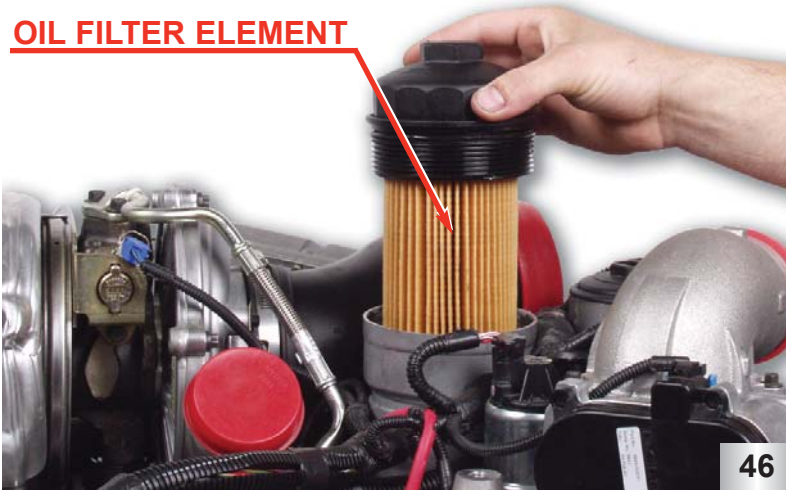

46

Oil Filter

- The 6.0L *POWER STROKE* uses a cartridge style oil filter, located on the top of the engine.
- When the oil filter is removed, the oil filter housing drain valve is automatically opened to drain most of the oil from the housing.
- The oil filter element snaps into the oil filter lid.
- **Note: The oil filter lid should be removed before draining the oil from the oil pan so that the oil can drain from the filter housing into the oil pan.**

OIL RESERVOIR SCREEN



47

Oil Reservoir & Screen

- The oil reservoir for the high pressure oil pump is located under the oil cooler in the valley of the engine.
- The oil reservoir holds about 1qt of oil.
- A screen in the oil reservoir catches any large debris that may be in the oil before it gets to the high pressure oil pump.

LUBRICATION SYSTEM

Oil Flow at Oil Reservoir

- There are five (5) oil passages and one coolant passage near the oil reservoir in the crankcase.
- Two (2) of the oil passages are for oil feed to the crankcase for lubrication.
- One (1) is for oil feed to the oil cooler and the other oil passage is oil filter drain to the oil pan.
- The passage in the bottom of the reservoir is for oil feed to the high pressure oil pump.
- The coolant passage is for coolant feed from the water pump to the oil cooler.

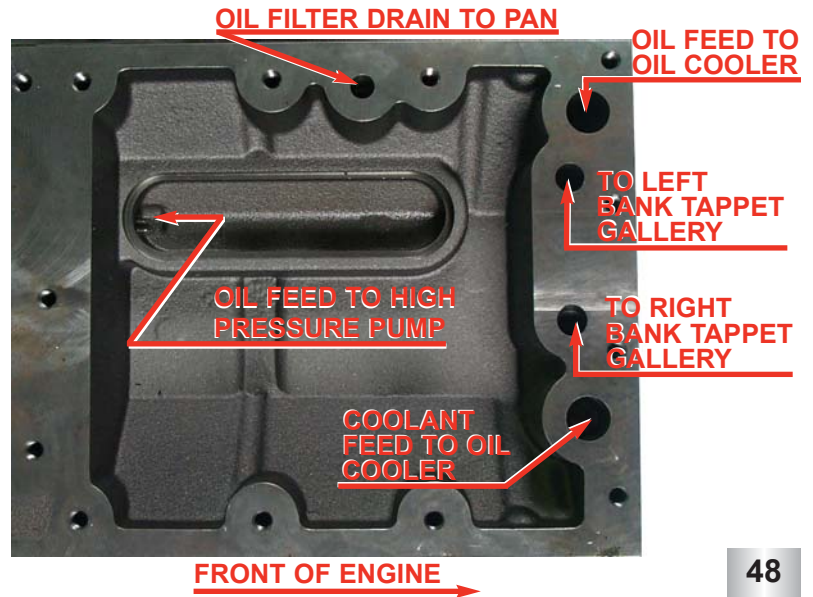

Turbocharger Oil Supply & VGT Control

- Oil is supplied to the turbocharger from the oil filter base via a flexible steel braided oil line to the top of the turbocharger.
- The oil line is connected to the oil filter base using a snap to connect fitting and requires a special tool for removal.
- This line is also the feed to the VGT control valve.

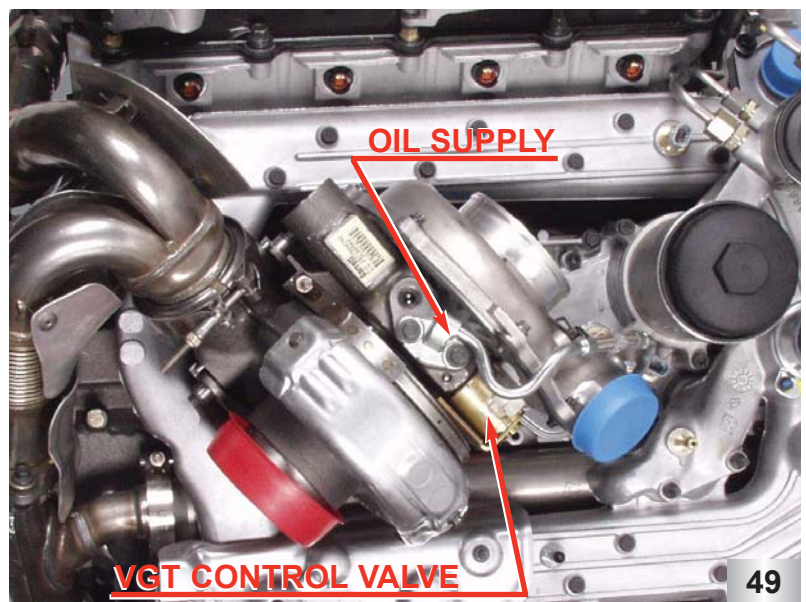

Turbocharger Oil Drain Tube

- The VGT uses oil to control the turbocharger and to lubricate the bearings.
- After oil passes through the turbocharger center section, it is sent back to the crankcase via a turbo oil drain tube.
- The turbo oil drain tube is located under the turbocharger and is sealed with two (2) o-rings, one fits into the turbocharger and the other goes to the high pressure oil pump cover.

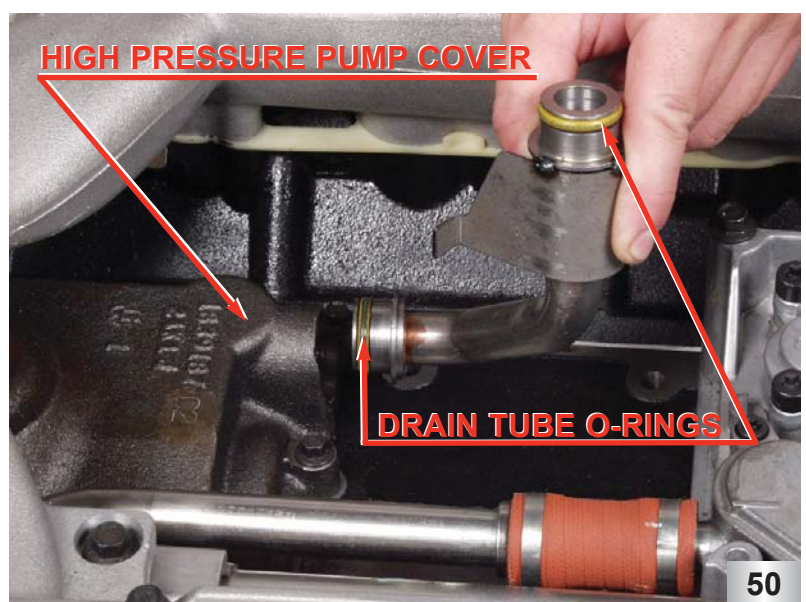

FUEL SUPPLY SYSTEM

Fuel Supply System Features

- Horizontal Fuel Conditioning Module (HFCM)
- Secondary Fuel Filter
- Fuel Check Valves

51

Fuel Supply System Features

- The fuel supply system uses a new Horizontal Fuel Conditioning Module (HFCM). The HFCM filters fuel, separates water, senses water, heats fuel, and recirculates warm fuel through the pump during cool fuel conditions.
- The 6.0L *Power Stroke* also has a secondary fuel filter.
- There is a check valve in the front of each cylinder head that does not allow fuel to return to the fuel supply system. This type of system is called a dead-end fuel system.

Engine Fuel System Flow

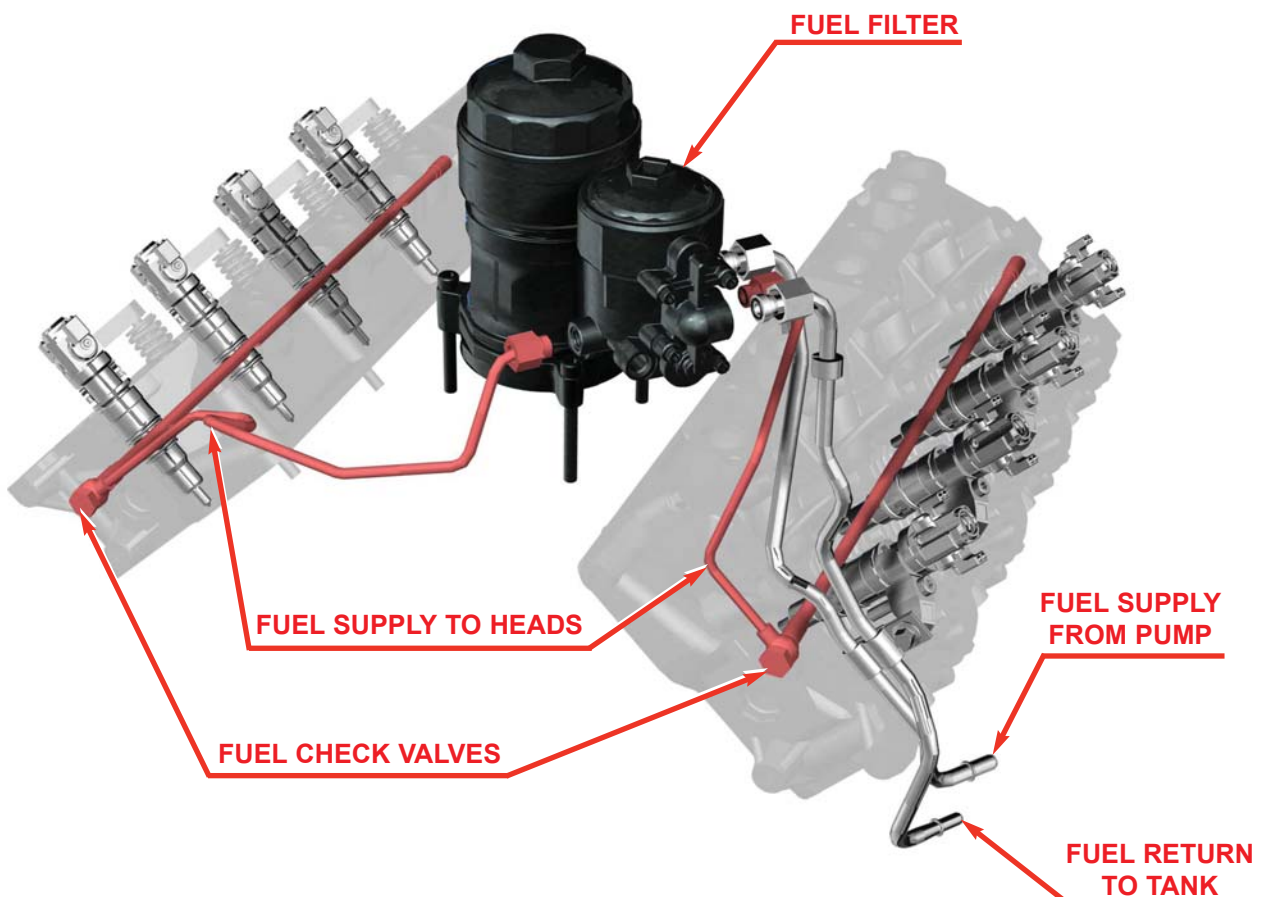

52

27

FUEL SUPPLY SYSTEM

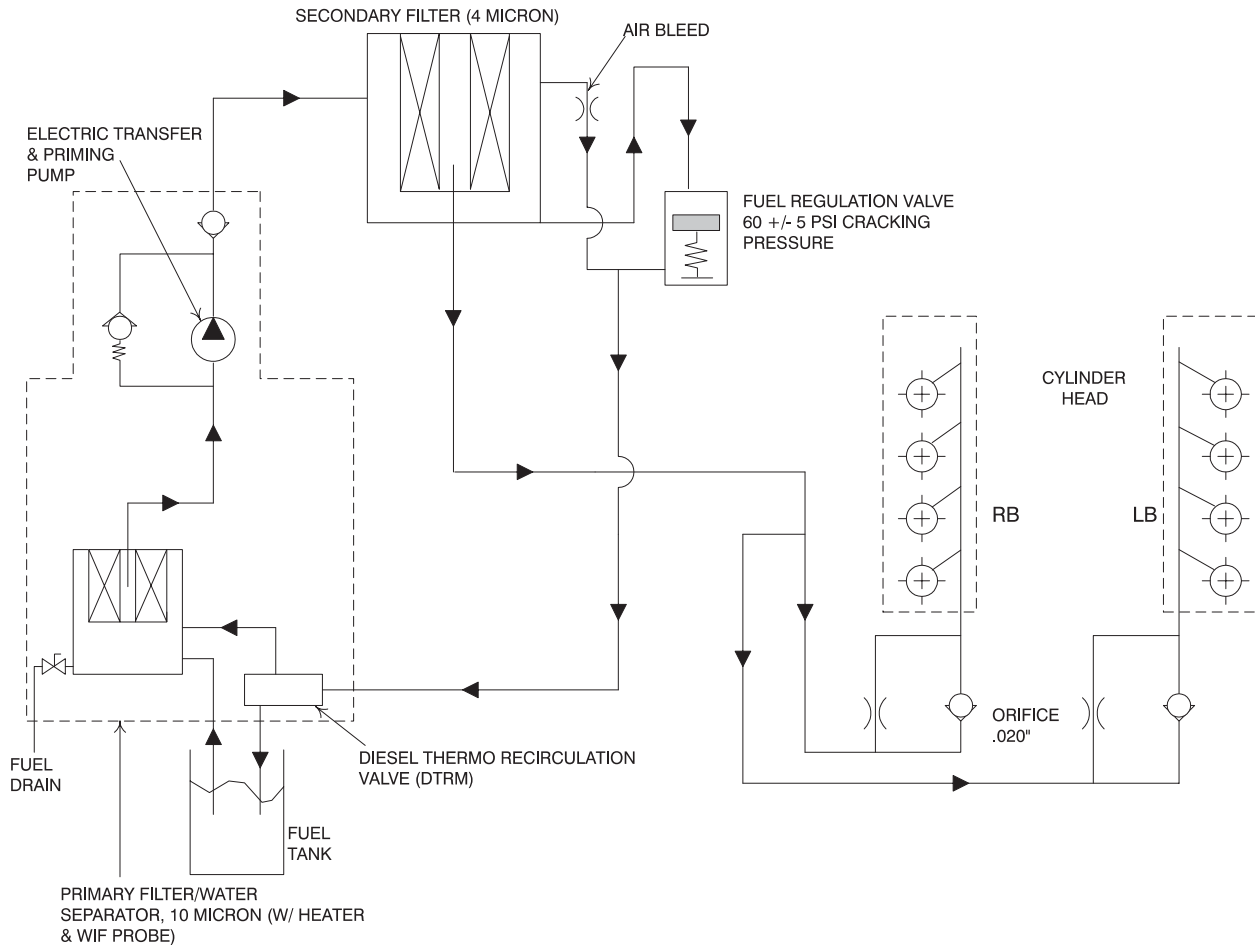

53

Engine Fuel Flow

- The fuel pump, located in the Horizontal Fuel Conditioning Module (HFCM), draws fuel from the fuel tank and through a 10 micron fuel filter.
- The HFCM contains the fuel pump, filter, water separator, water in fuel switch, fuel drain, fuel heater, and diesel thermo recirculation valve (DTRM).
- The DTRM controls the flow of fuel returned from the secondary filter through the HFCM. If the fuel being drawn from the fuel tank is cool then return fuel is recirculated into the pump, if it is warm then return fuel is sent to the fuel tank
- After the fuel is conditioned by the HFCM, the clean pressurized fuel is sent to the secondary fuel filter assembly where particles larger than 4 micron are filtered out of the fuel.
- The secondary filter assembly also regulates fuel pressure by releasing excess pressure via a return fuel line back to the HFCM.
- It also has an orifice at the top of the housing in order to bleed air out of the housing and back to the fuel tank.
- After the fuel flows through the secondary filter it is directed to the two (2) cylinder heads via fuel lines past the fuel check valves.
- The fuel is directed to the injectors via passages that are drilled into the cylinder heads.
- Once the fuel has entered the head past the check valve, it does not return to the fuel supply system. This is called a dead-end fuel system.

FUEL SUPPLY SYSTEM

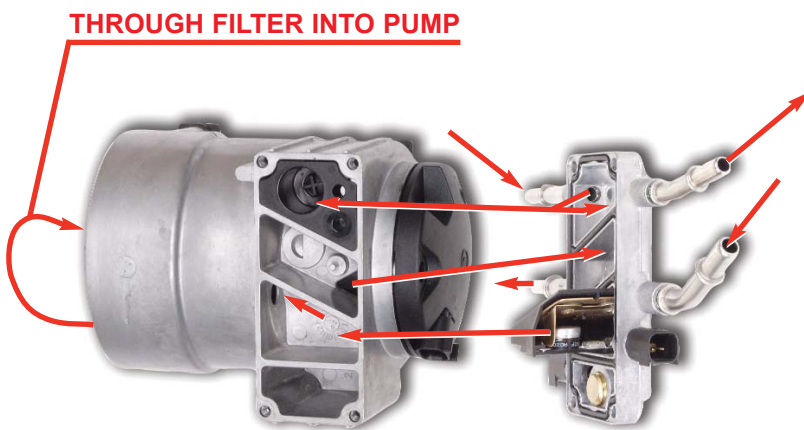
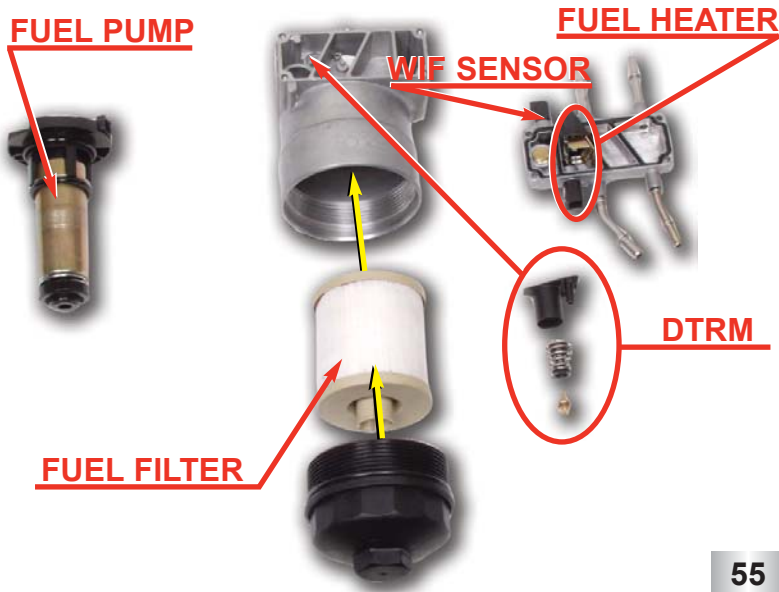
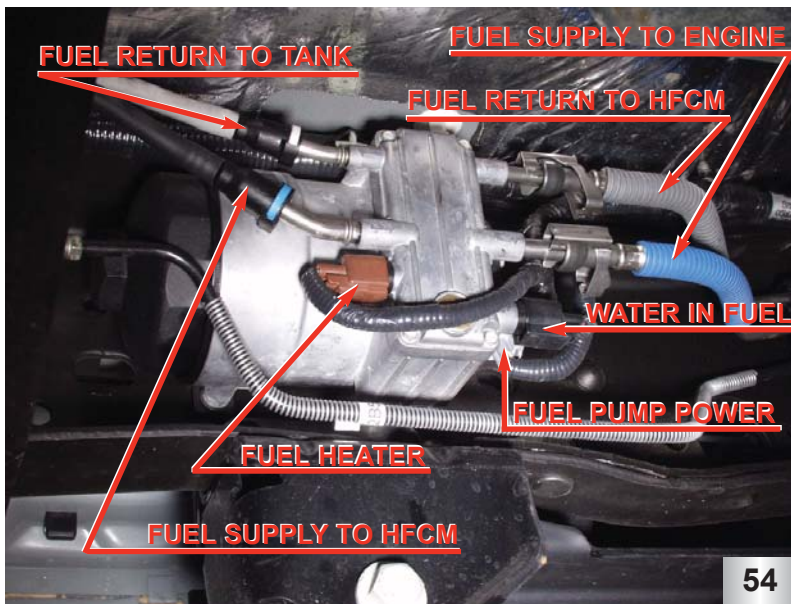

HFCM (Horizontal Fuel Conditioning Module)

- The HFCM is mounted to the frame rail on the drivers side.
- The HFCM is a single module that performs multiple tasks. It heats fuel, separates water from the fuel, senses when water is present in the fuel, filters particulates from the fuel, creates fuel pressure needed to to supply fuel to the engine mounted fuel filter
- A DTRM (Diesel Thermo Recirculation Module) is also part of the HFCM. It recirculates fuel that returns from the engine mounted fuel filter back into the fuel filter instead of back to the tank, which in cool fuel conditions.

HFCM (Horizontal Fuel Conditioning Module) Fuel Flow

- Fuel is drawn into the HFCM from the fuel tank via a supply line.
- If the temperature of the the fuel is below 50°F (10°C) it is heated by the fuel heater. The fuel heater shuts off at 80°F (27°C).
- After being heated, fuel enters the filter housing via a one-way check valve.
- Once in the filter housing, water is separated from the fuel. If large amounts of water are found in the fuel, a sensor in the separator warns the operator of this condition by illuminating a light on the dash.
- Fuel is then drawn through the 10 micron fuel filter and into the fuel pump.
- Conditioned pressurized fuel is then supplied to the engine mounted fuel filter via a fuel supply line. The pump has an internal regulator that limits fuel pressure to 100psi.
- Fuel returning from the pressure regulator on the engine mounted fuel filter comes into the HFCM and a DTRM either allows the fuel to return to the tank or returns it to the unfiltered side of the fuel filter in the HFCM. The DTRM starts to open (recirculating fuel back into the pump) at 80°F (27°C) and is fully open at 50°F (10°C).

FUEL SUPPLY SYSTEM

Engine Mounted Fuel Filter

- A secondary fuel filter is mounted to the oil filter housing.
- The secondary filter is a 4 micron cartridge style filter.
- It also incorporates a fuel pressure regulator and an air bleed (to allow air to escape after a filter change). Fuel from the regulator is returned to the HFCM.

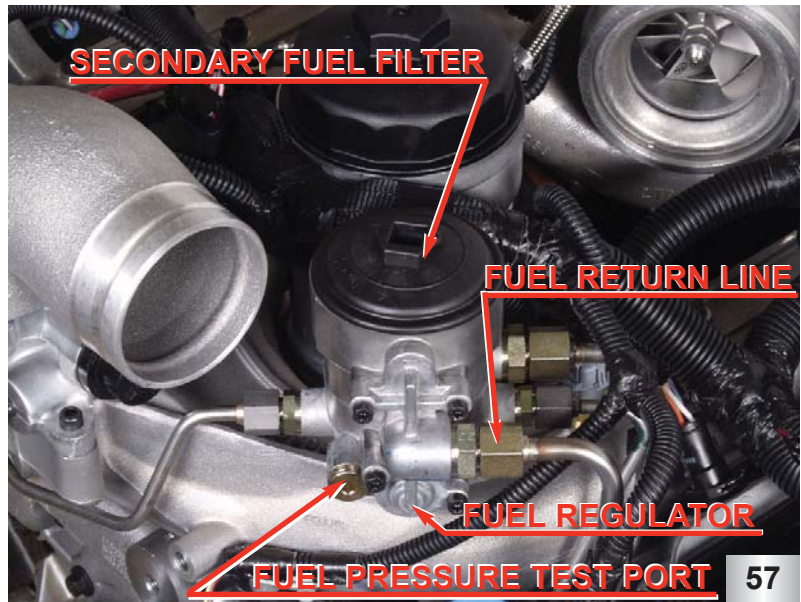

Fuel Pressure Regulator

- The fuel pressure regulator is mounted to the engine mounted fuel filter.
- It regulates fuel pressure by routing unfiltered fuel from the filter housing to the HFCM via a spring loaded poppet style valve.
- The cracking pressure (pressure at which the valve begins to open) of the valve is 60psi \pm 5psi. Actual fuel pressure may be above or below this specification.

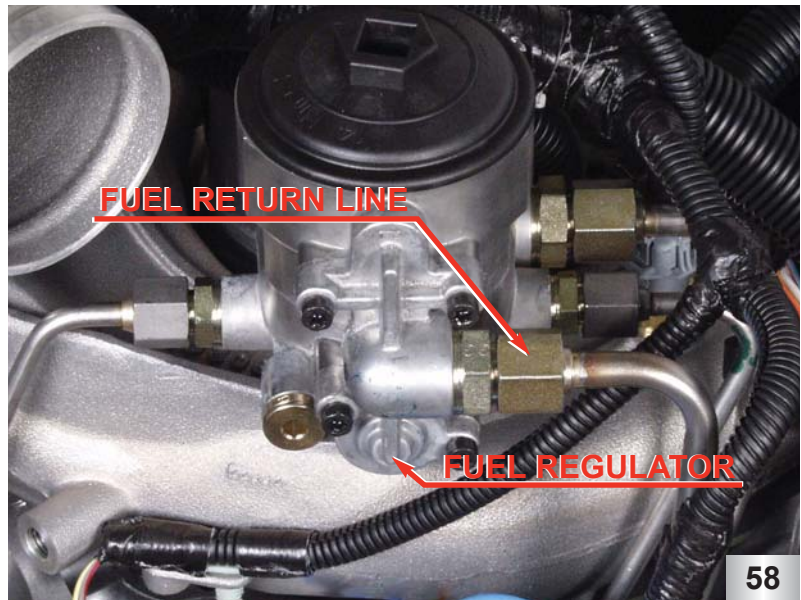

Fuel Inlet Check Valves

- Each cylinder head has a fuel inlet check valve at the front of the head.
- The check valve is incorporated into the bolt for the banjo fitting that attaches the fuel line to the head.
- The check valves are used to maintain constant fuel pressure in the fuel rail.
- The fuel lines are sealed to the head by two copper gaskets.
- **Note: It is recommended that the copper gaskets be replaced if the bolt has been removed.**

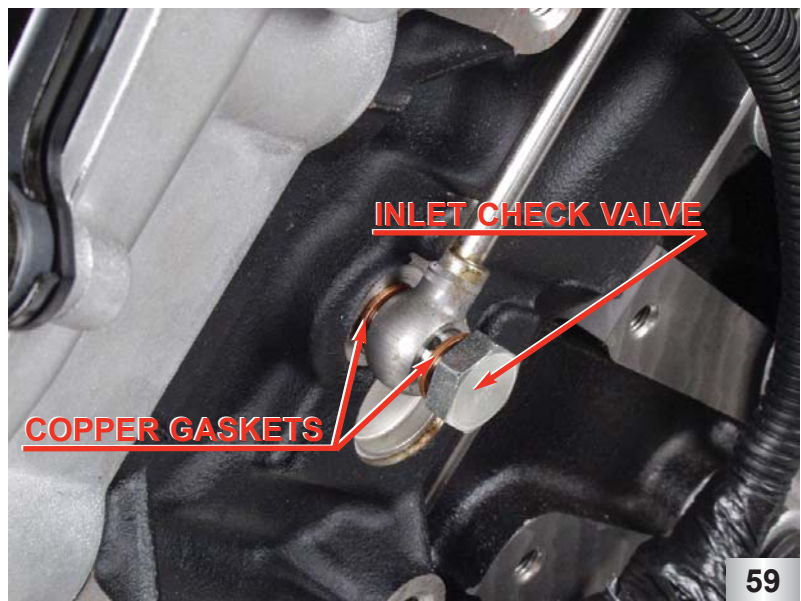

AIR MANAGEMENT SYSTEM

Air Management System Components/Features

- Air Filter/Filter Minder
- Variable Geometry Turbocharger (VGT)
- Charge Air Cooler
- Intake Manifold
- EGR System

60

Air Management System Features

- The air management system is made up of the air filter, turbocharger, charge air cooler, intake manifold, and the EGR system.

Air management System Flow

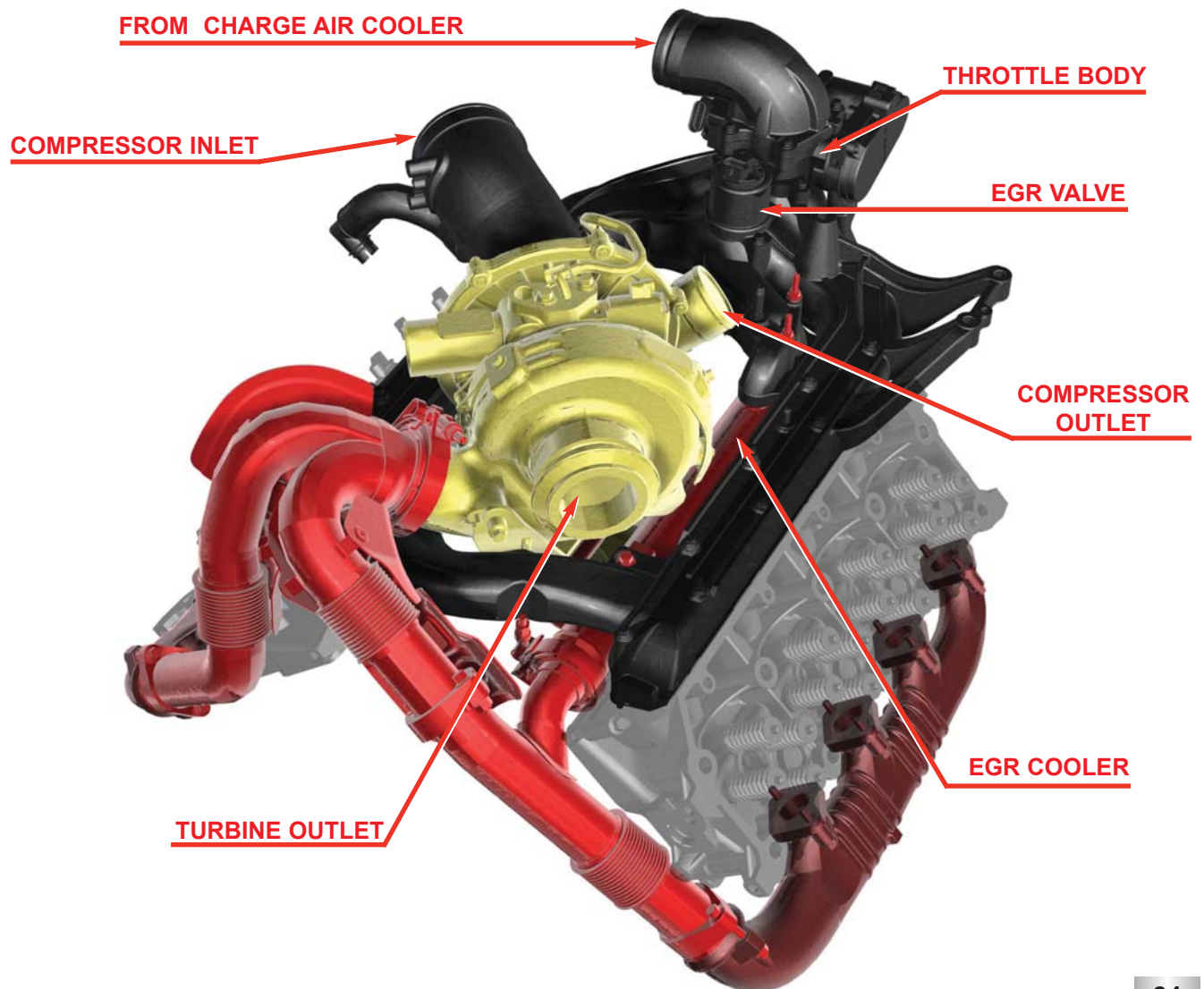

61

AIR MANAGEMENT SYSTEM

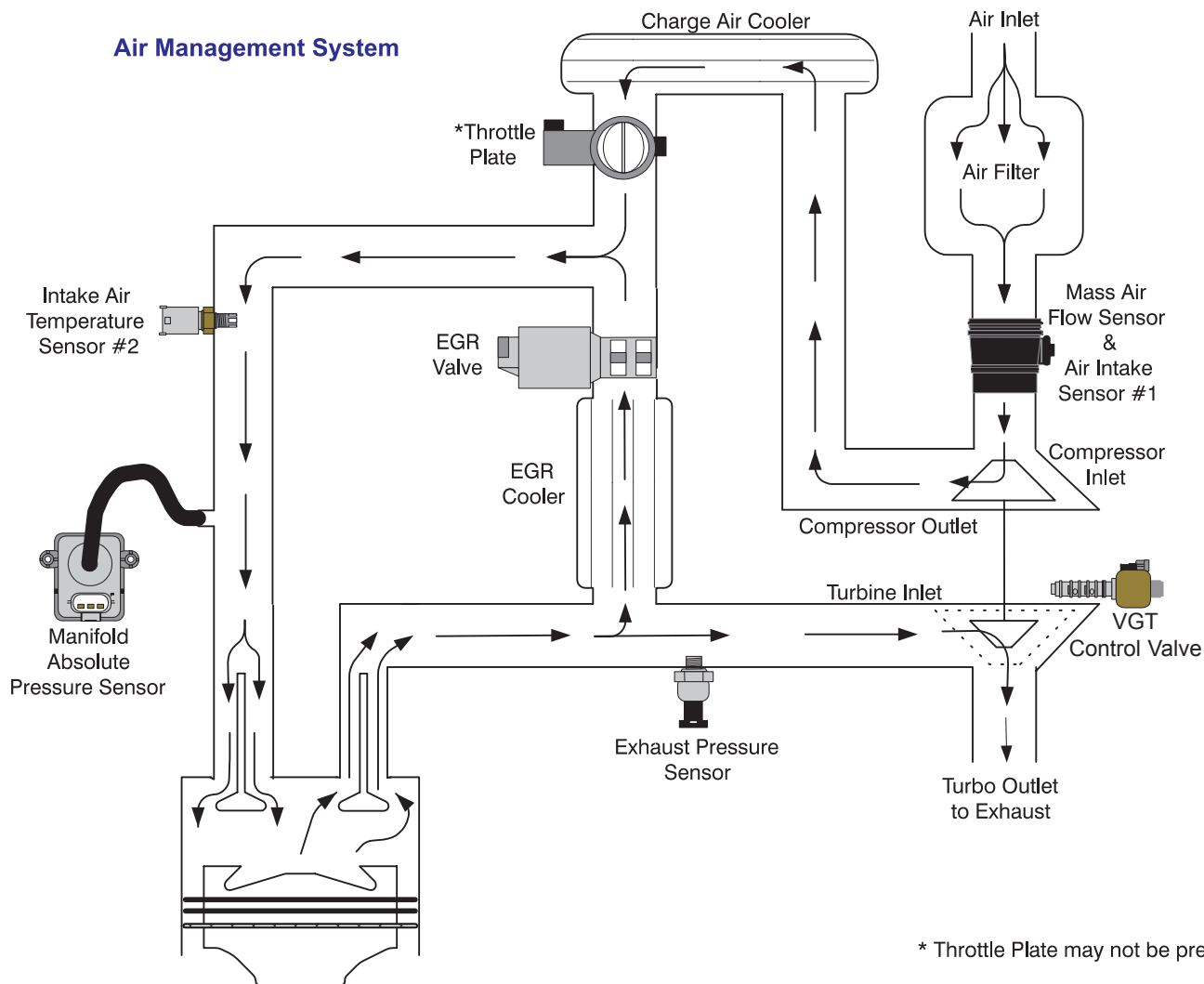

* Throttle Plate may not be present

System Flow

- Air enters the system through the air filter where particles are removed from the air. The air filter has a filter minder on it to warn the operator of a restricted air filter.
- After the air is filtered, the mass of the air and temperature is measured by the mass air flow sensor (MAF).
- The filtered air is then directed past the crankcase ventilation system where crankcase vapors and fresh air are mixed.
- After mixing with crankcase vapors the fresh air mixture is drawn into the turbocharger compressor where it is compressed and sent to the charge air cooler (CAC).

- The CAC condenses the air by cooling it then the air returns to the engine through the intake manifold.
- There is a throttle body on the intake manifold. The throttle body may or may not have a throttle plate. For 2003.25 the throttle plate will not be active in the pcm strategy
- The intake manifold directs the air to the intake ports of the cylinder heads.
- The burned air fuel mixture is pushed out of the cylinder into the exhaust manifold which collects the exhaust gases and routes them to the turbocharger turbine wheel.
- The exhaust up pipe, connected to the passenger side exhaust

manifold has a passage that connects it to the exhaust gas recirculation (EGR) cooler.

- The exhaust gasses, cooled by the EGR cooler are sent to the EGR valve in the intake manifold.
- The EGR valve controls the flow of exhaust gases into the intake system where the gases are mixed with intake air to reduce NOx (Nitrogen Oxide) emissions and noise.
- The hot and expanding exhaust gases that are routed to the turbocharger turbine, spin the turbine wheel through flow and expansion. The spinning turbine wheel in turn spins the compressor wheel via a common shaft.

AIR MANAGEMENT SYSTEM

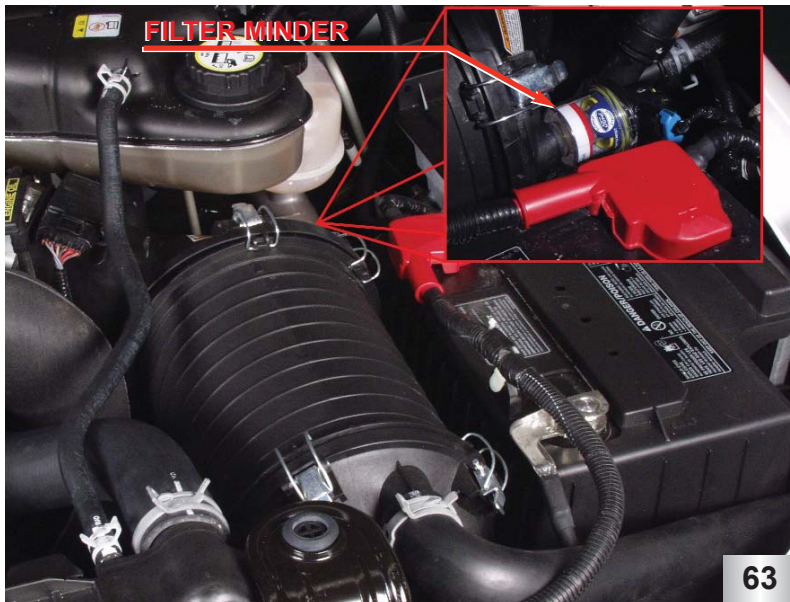

Air Filter / Filter Minder

- The air filter is located on the drivers side of the engine compartment between the battery and the radiator.
- A filter minder, device used to measure filter restriction, is located on the back of the air filter housing.
- Fresh air, from the drivers side fender and the grill area, is drawn into the air filter and particulates are removed from the air before going to the engine.

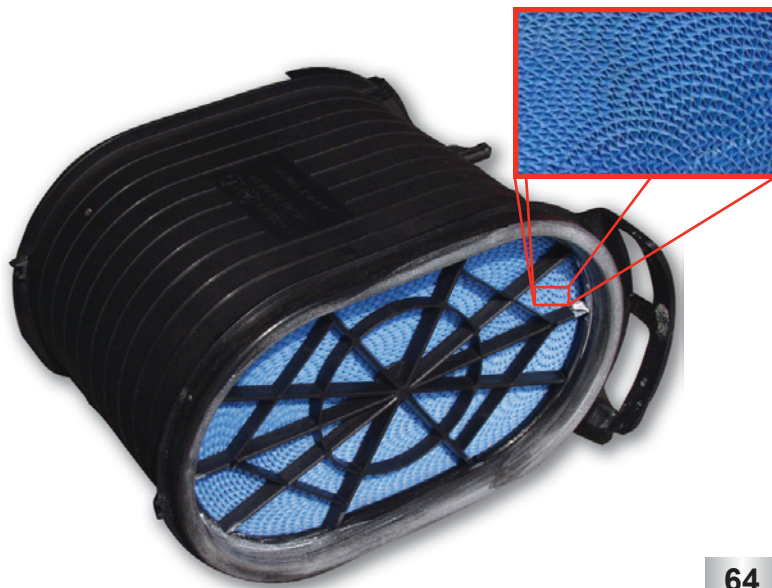

Air Filter Element

- The new air filter element is made into the air filter housing. When replacing the filter, the entire housing will have to be replaced.
- The air filter is capable of holding 1600 grams of particulates before needing replacement.
- The filter element is a honeycomb design.

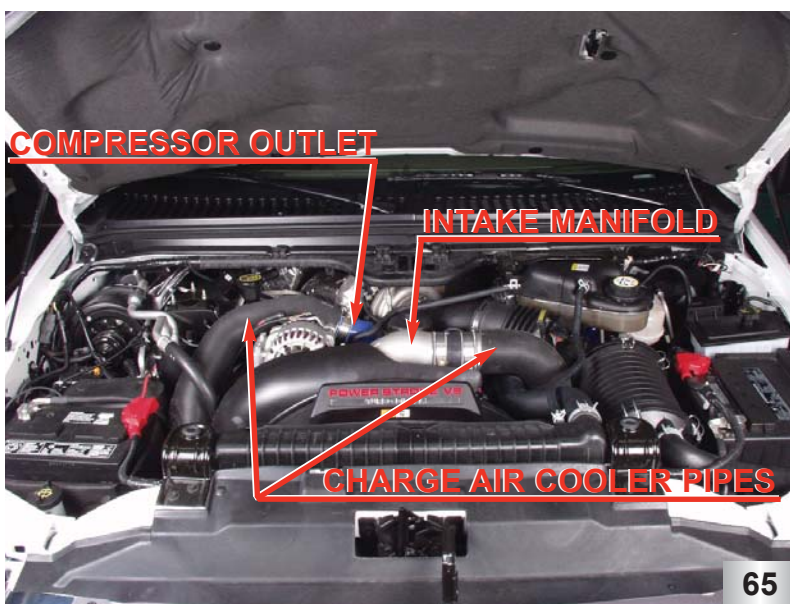

Charge Air Cooler

- The charge air cooler is located in the front of the radiator.
- It is an air to air cooler designed to lower the temperature of the air coming out of the turbocharger outlet before entering the intake manifold.

AIR MANAGEMENT SYSTEM

VGT Features

- The turbocharger for the 6.0L *Power Stroke* engine is designed to provide boost control at low and high speeds for improved throttle response.
- The Variable Geometry Turbocharger (VGT) is electronically controlled and hydraulically actuated.
- The VGT may also be referred to as EVRT.
- When the vanes of the turbocharger are closed, the engine will have a higher exhaust back pressure and create more heat which will in turn warm the engine faster in cold ambient conditions.

VGT Compressor

- The compressor on the VGT is similar to the compressor on a conventional turbocharger.
- The compressor wheel is connected to the turbine via a common shaft.

VGT Turbine

- The VGT uses a turbine wheel that is similar to a conventional turbocharger but the turbine housing has changed.
- The turbine housing contains vanes that control the effective size of the housing. These vanes are hydraulically actuated and electronically controlled.

VGT Turbocharger Features

- Electronically Controlled Hydraulically actuated
- Low & High Engine Speed Boost Control
- Incorporates Fast Warm-Up Device

66



67

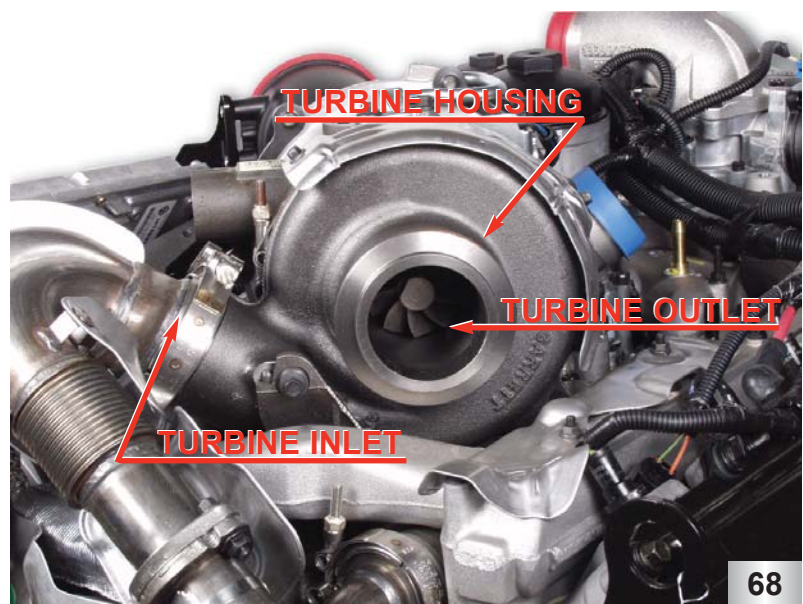

68

AIR MANAGEMENT SYSTEM

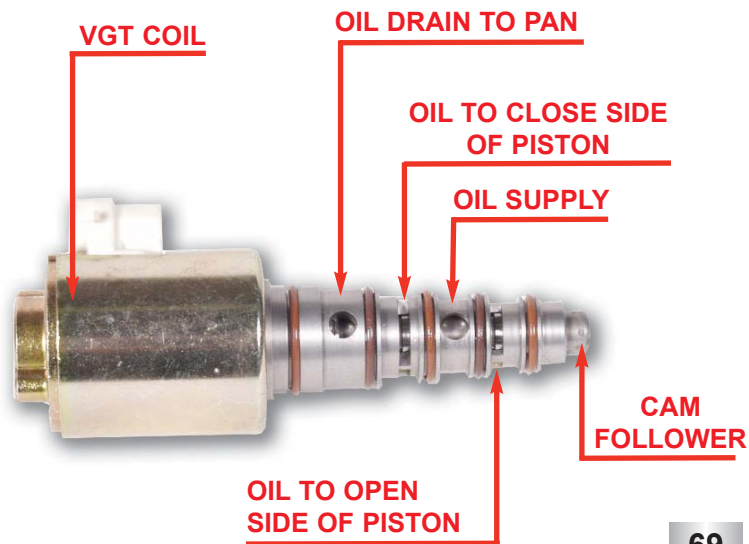

69

VGT Control Valve KOEO
Turbo Vanes Full Open

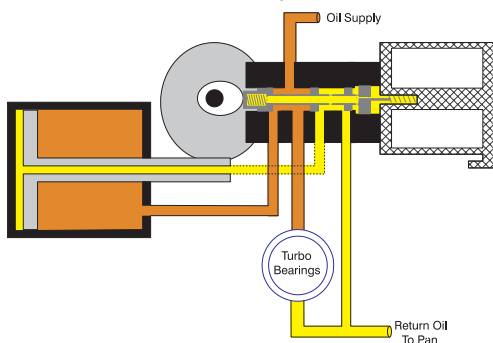

70

VGT Control Valve
Turbo Vanes Mid Position

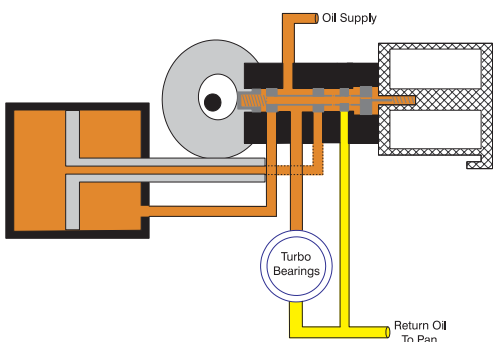

71

VGT Control Valve
Turbo Vanes Full Closed

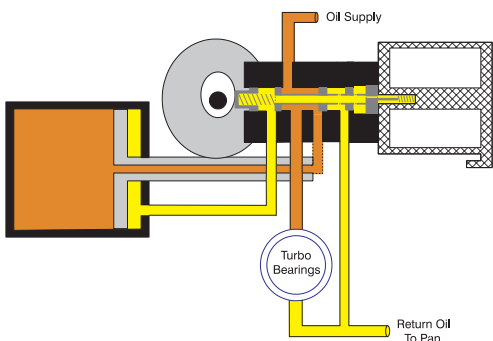

72

VGTCV Control Valve

- The VGTCV control valve is commanded by the PCM, based on engine speed and load. The magnetic field generated by this signal moves a shaft in the control valve. This movement meters engine oil through the valve to either side of the piston. This design feature reacts quickly to changes in demand based on driving conditions. When one side of the piston is pressurized, the opposite side is vented.
- Depending on which side of the piston is pressurized, the vanes either open or close. A cam follower at the end of the valve assembly provides feedback to the valve allowing it to reach a neutral position during times the vanes are not commanded to move.

VGTCV Flows

- When the VGTCV is commanded to the full open position, low or no duty cycle, oil from the oil supply line is directed to the open side of the actuator piston.
- Oil on the closed side of the piston is then directed through the actuator piston, back to the VGTCV, and then to drain.
- Note: If the VGTCV is disconnected the valve will default to the open position.
- Once the desired turbocharger vane position is obtained, the VGTCV goes to a neutral position and both the open and closed sides of the actuator piston is blocked off.
- When the VGTCV is commanded to the full closed position, high duty cycle, oil from the oil supply line is directed through the actuator piston to the closed side of the piston.
- Oil on the open side of the piston is directed back to the VGTCV and then to drain.

AIR MANAGEMENT SYSTEM

VGT Turbine Vanes Closed

- During engine operation at low engine speeds and load, little energy is available from the exhaust to generate boost. In order to maximize the use of the energy that is available, the vanes are closed. In doing so, the exhaust gas is accelerated between the vanes and across the turbine wheel. In general, this allows the turbocharger to behave as a smaller turbocharger than it actually is.
- Closing the vanes also increases the back pressure in the exhaust manifold which is used to drive the exhaust gas through the EGR cooler and valve into the intake manifold. This is also the position for cold ambient warm up.

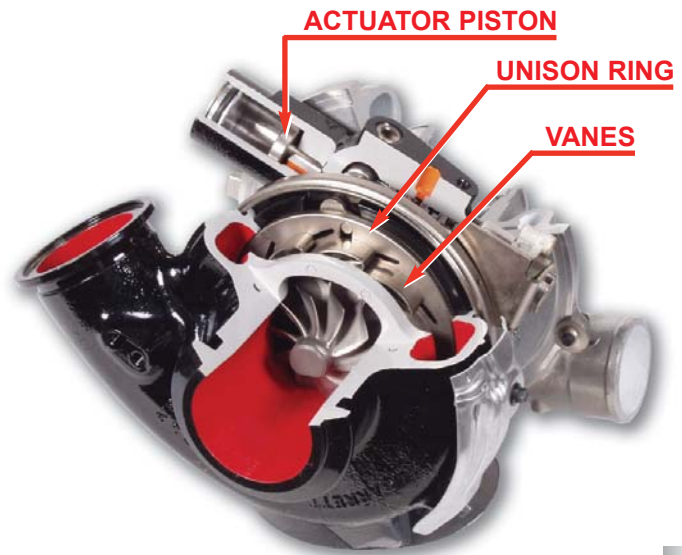

73

VGT Turbine Vanes Partially Closed

- During Engine operation at moderate engine speeds and load, the vanes are commanded partially open.
- The vanes are set to this intermediate position to supply the correct amount of boost to the engine for optimal combustion as well as providing the necessary back pressure to drive EGR.
- **Note: The VGT control valve piston is coupled to the vanes through a shaft and the unison ring.**

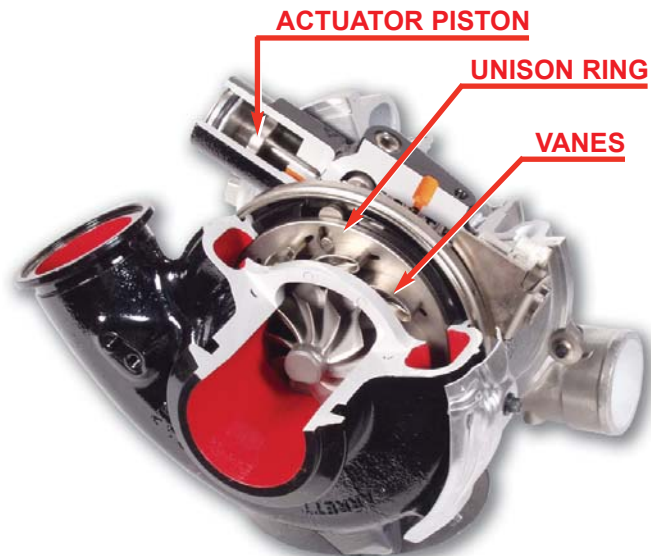

74

VGT Turbine Vanes Open

- During engine operation at high engine speeds and load, there is a great deal of energy available in the exhaust.
- Excessive boost under high speed, high load conditions can negatively affect component durability, therefore the vanes are commanded open preventing turbocharger overspeed.
- Essentially, this allows the turbocharger to act as a large turbocharger.

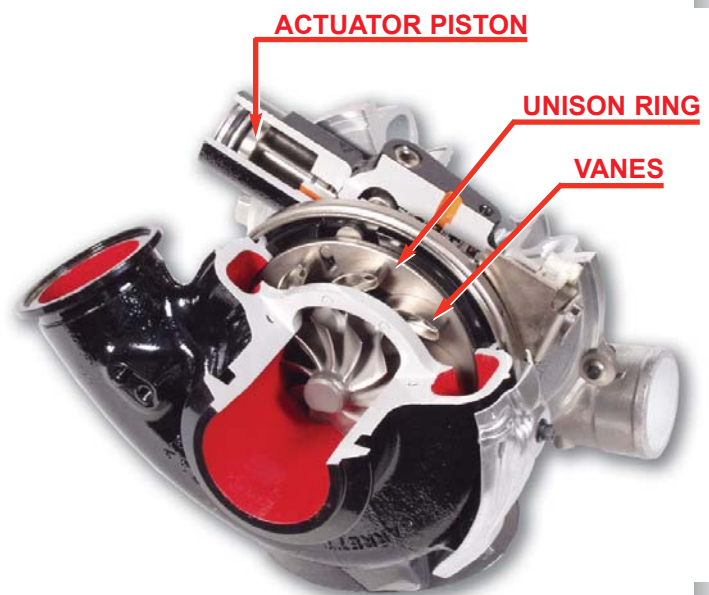

75

AIR MANAGEMENT SYSTEM

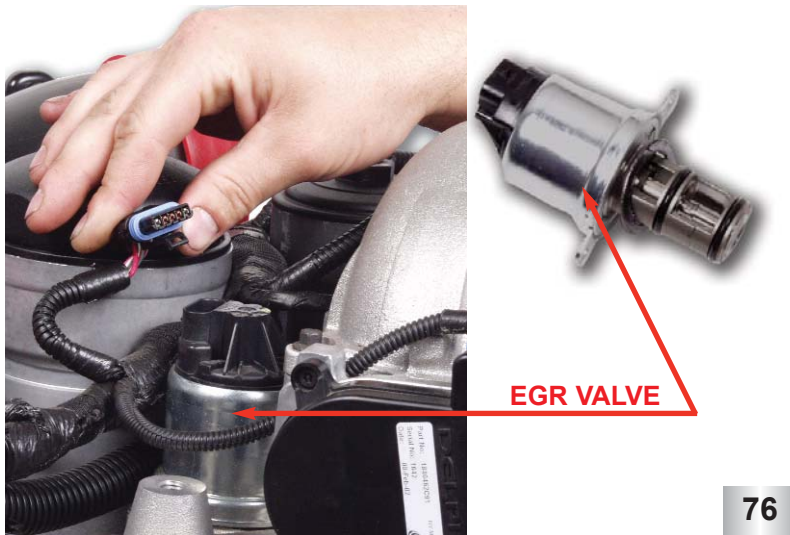

EGR Valve

- The PCM controlled EGR (Exhaust Gas Recirculation) valve adds cooled exhaust gases to the intake manifold to reduce NOx emissions.
- The EGR valve is opened during steady state throttle positions when exhaust back pressures are higher than intake manifold pressures (boost).

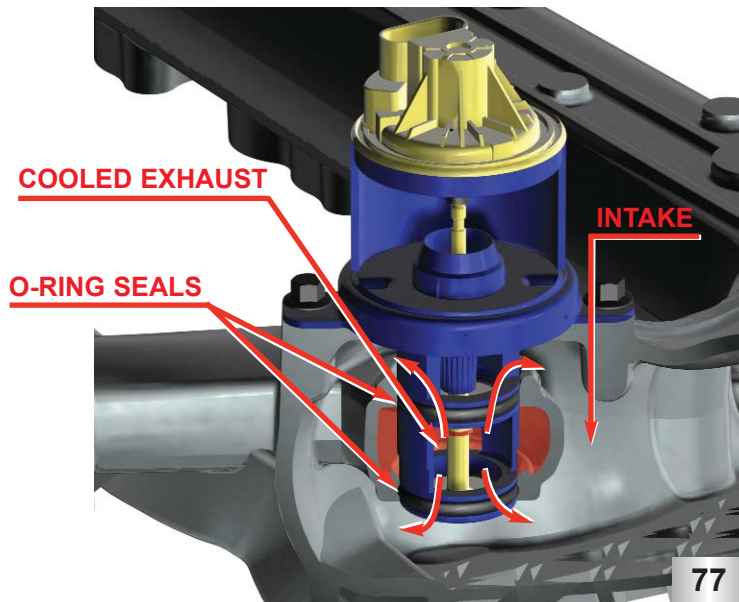

EGR Flow

- The EGR valve has two valves connected by a common shaft.
- Cooled exhaust gases come to the center of the valve through a passage in the intake manifold.
- When the valves open they allow exhaust gases to flow into the intake air stream from the top and bottom of the passage.

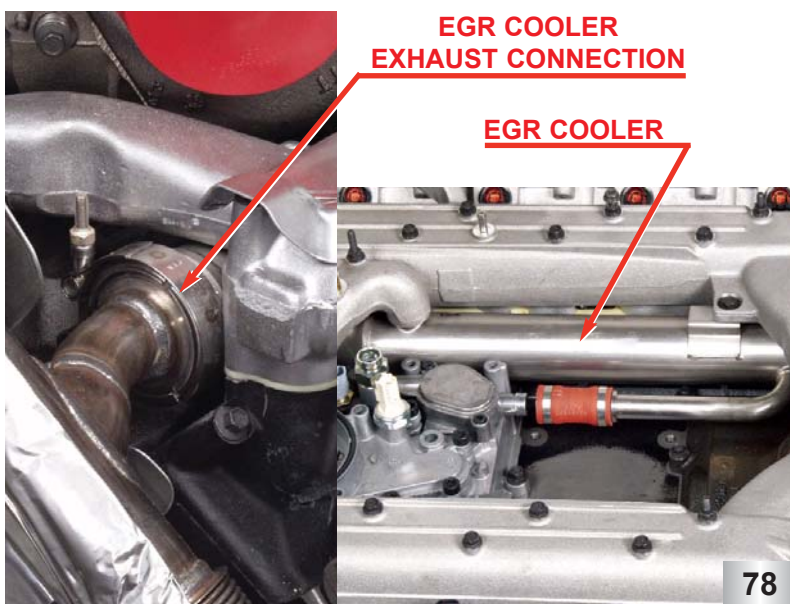

EGR Cooler

- The EGR cooler is a coolant to air heat exchanger that is used to cool the exhaust gases before they are sent to the EGR valve.
- The exhaust gasses are routed into the EGR cooler from the exhaust up pipes at the rear of the engine.
- The exhaust gasses are cooled by passing through metal tubes that are surrounded by engine coolant. Depending on conditions, the temperature drop across the cooler could be as much as 700°F.
- The cooled gasses are then routed to the EGR valve that is mounted in the intake manifold.

AIR MANAGEMENT SYSTEM

EGR Throttle

- All 2003.25 6.0L Power Stroke engines are equipped with a throttle body.
- Some early versions also have a throttle plate in the throttle body. Later versions will retain the throttle body, but not the throttle plate.
- The throttle was designed to assist with EGR operation, but later was determined unnecessary.
- The PCM software for controlling the throttle body was not added and the plate was removed.
- The throttle body may become operational for the 2004 model year.
- **Note:** All engines have the wiring plugged into the throttle body and position sensor even if the throttle plate is not present.

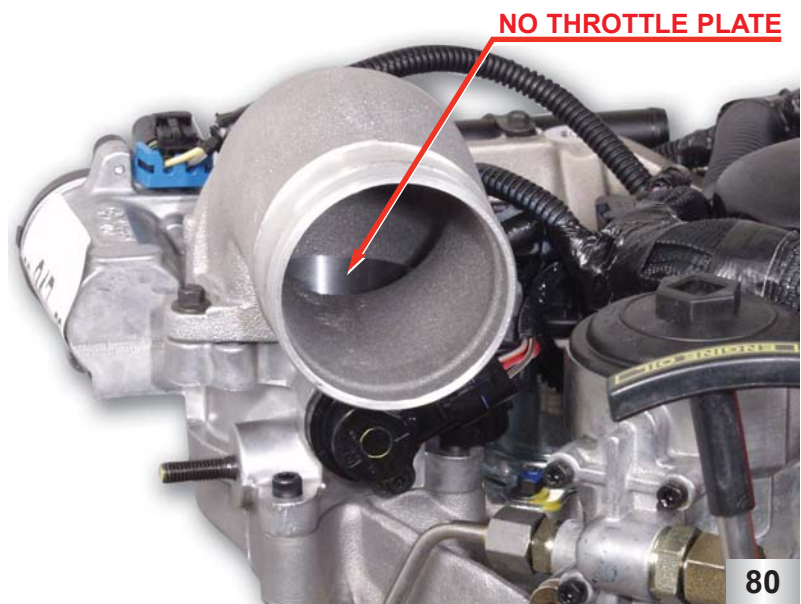
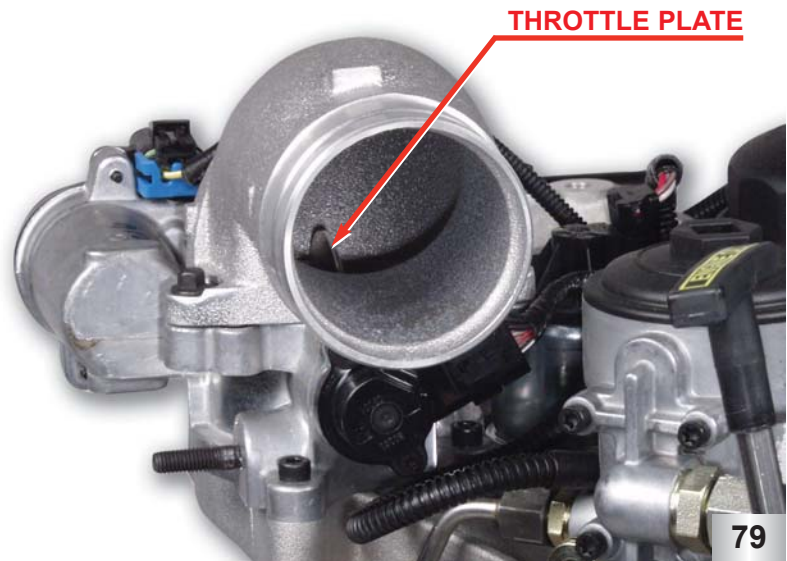

Intake Manifold

- The intake manifold on the 6.0L *Power Stroke* is made of aluminum and directs the flow of air to the intake ports in the cylinder heads.
- The Intake manifold provides a path for coolant from the EGR cooler to the front cover.
- There is a passage for EGR gasses to go to the EGR valve where they mix with compressed intake air.
- The manifold absolute pressure sensor (MAP) port and the intake air temperature 2 (IAT2) sensor are both mounted in the intake manifold.
- The passage at the rear of the manifold is to equalize pressure on both sides of the manifold.



FUEL MANAGEMENT SYSTEM

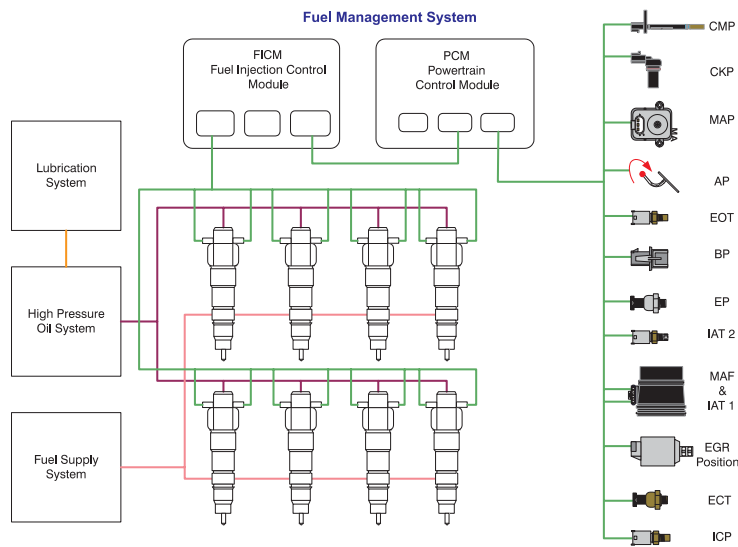

82

Fuel Management System Major Components

- Fuel Supply System
- High Pressure Oil System
- Lubrication System
- Sensors
- Injectors
- Electrical Components
- Actuators

83

Fuel Management System Features

- Emissions
- Noise
- Rate Control
- Timing Control
- No External High Pressure Lines
- IPR valve with integrated pressure relief

84

Generation II Fuel Management System Diagram

- The generation II fuel management system uses high pressure oil and electronics to actuate and control fuel injection into the cylinders.

Generation II Fuel Management System Major Components

- The fuel management system is comprised of several sub systems.
- Fuel Supply System.
- High Pressure Oil System.
- Lubrication System.
- Sensors.
- Injectors.
- Electrical Components.
- Actuators.

Generation II Fuel Management System Advantages

- Emissions and noise have been reduced through improvements in rate and timing control.
- No external high pressure oil lines exist.
- The high pressure system's pressure relief is located in the IPR (Injection Pressure Regulator).

FUEL MANAGEMENT SYSTEM

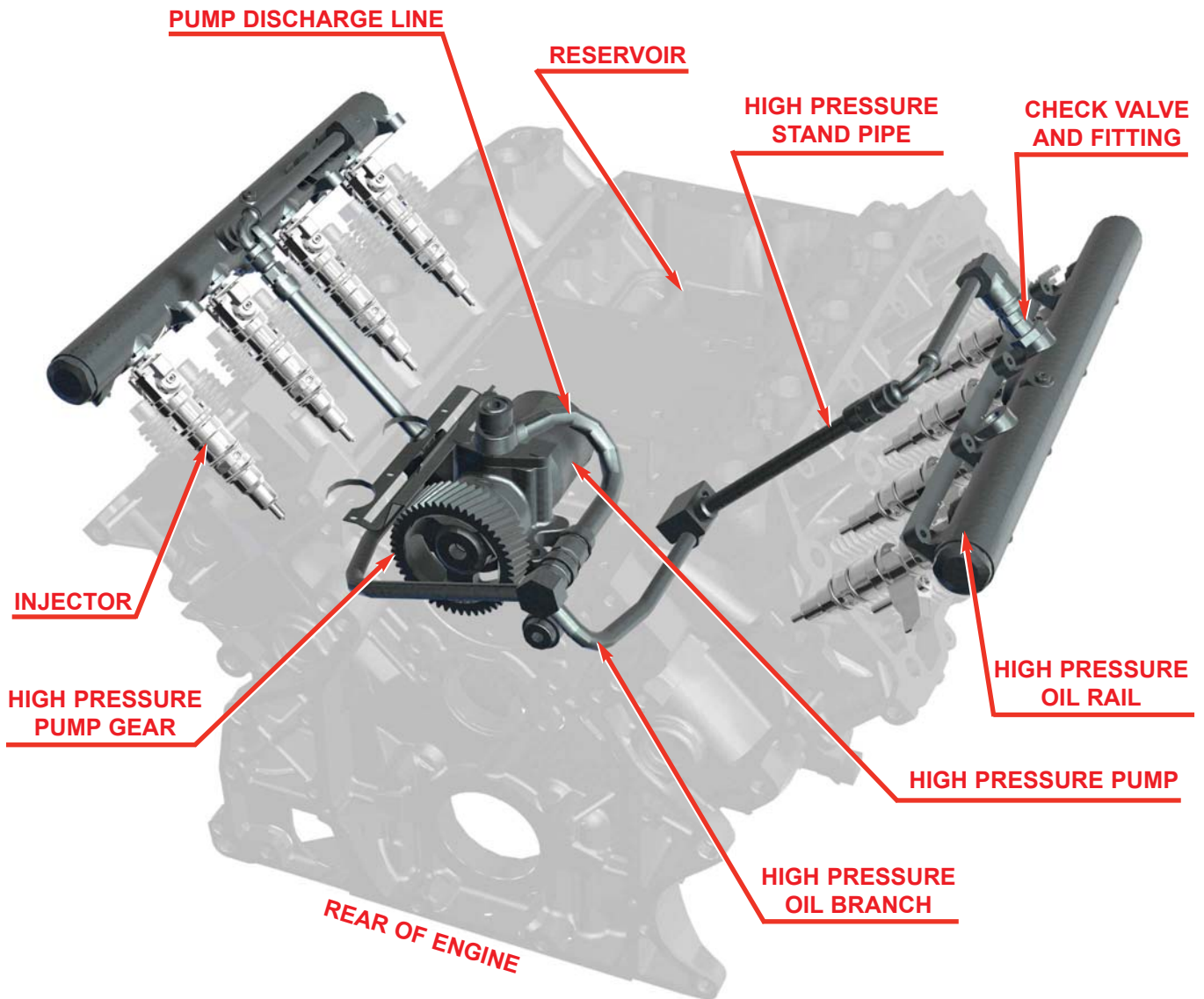

85

High Pressure Oil System Flow

- Oil reservoir is filled by the lube oil system and contains approximately 1 qt.
- High pressure pump is sealed inside the crankcase, and has only one (1) outlet.
- High pressure pump discharge line connects the pump to the left and right branches and to the IPR valve in the high pressure pump cover.
- High pressure oil stand pipe connects to the branch outlets and provides a path through the pushrod area to the high pressure lines.
- High pressure oil line connects the stand pipes to the high pressure oil rail.
- High pressure oil rail is bolted to the cylinder heads and acts as a reservoir for high pressure oil.
- Check valves incorporated in the inlet fitting for the high pressure oil rail, limit hydraulic disturbance/feed back from injector operation.
- Injectors deliver fuel when the spool valve is positioned to allow oil to enter the area above the intensifier piston.

High Pressure Oil System Schematic

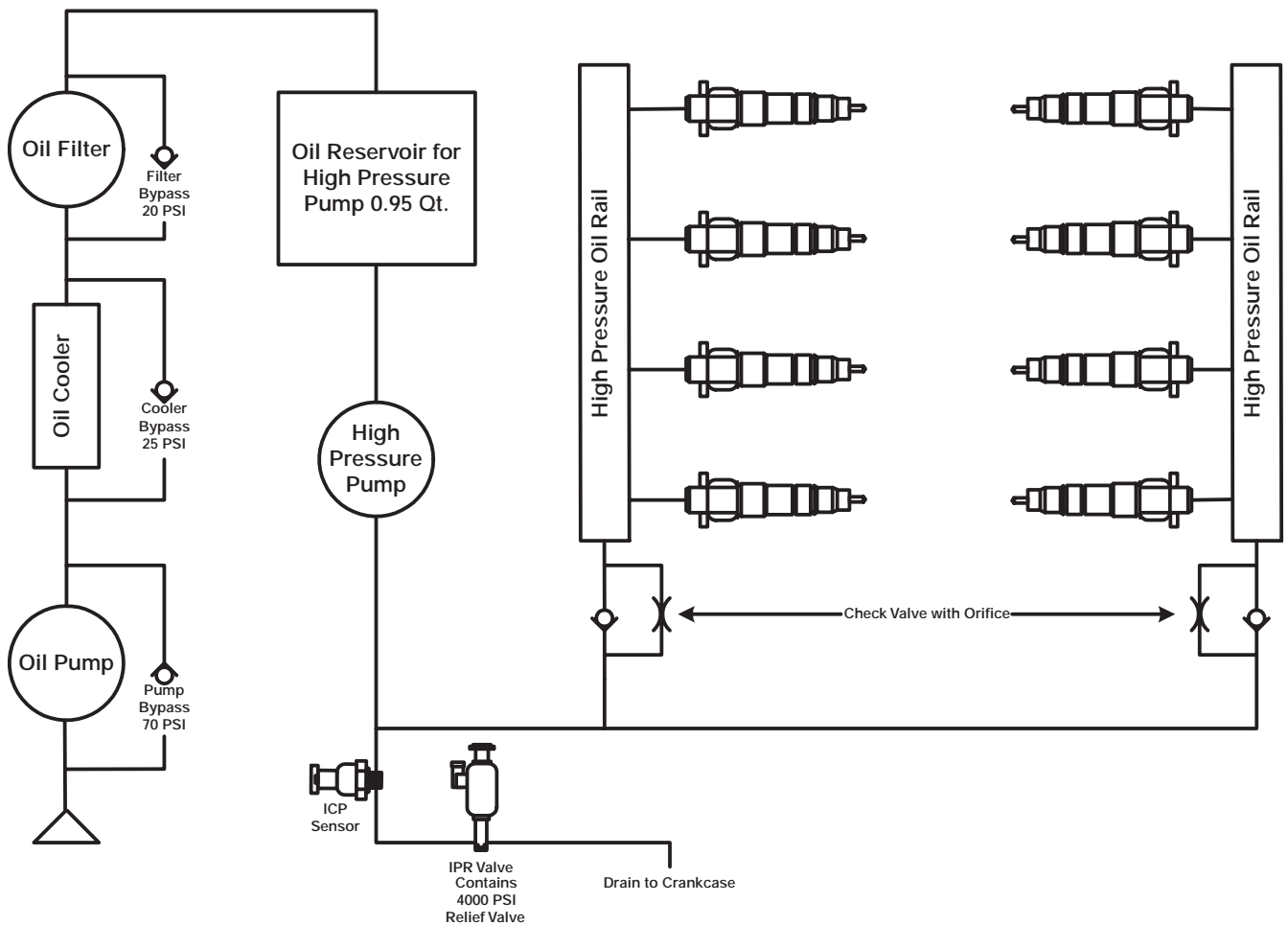

High Pressure Oil System Schematic

- After lube oil is cooled and filtered, some is directed to the reservoir.
- The reservoir provides oil to the high pressure pump.
- The IPR (Injection Pressure Regulator) is PCM controlled and contains the system's pressure relief valve which opens at 4000 psi.
- The plumbing from the pump to the high pressure oil rails for each head contains a check valve and orifice.
- The oil rails are not cast into the head but are removable and

fastened to the cylinder head and connected to the top of the injectors.

FUEL MANAGEMENT SYSTEM

High Pressure Pump & Cover

- The high pressure pump is installed inside the crankcase.
- The pump is a seven (7) piston swash plate style pump that is driven off of the rear gear train.
- Minor leakage from the pump will not create external oil leaks.
- Both banks of cylinders are supplied oil through one (1) pump outlet.

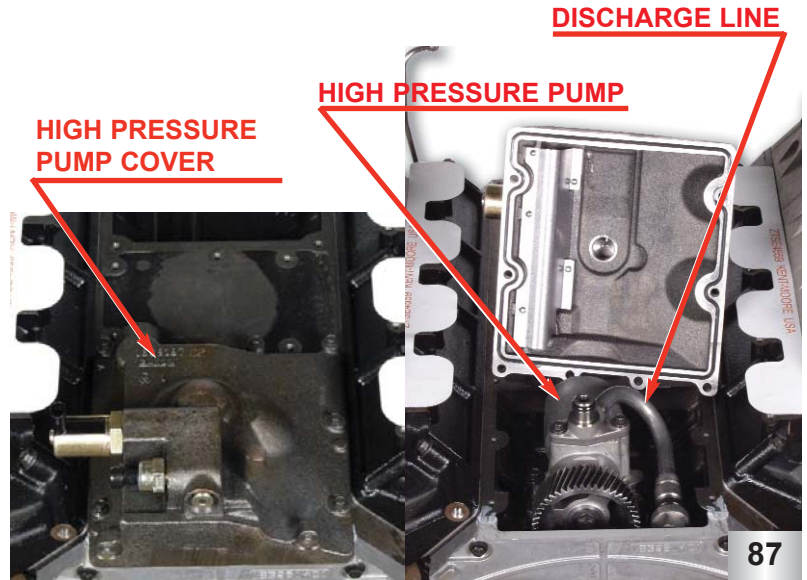

IPR (Injection Control Pressure Regulator) & ICP (Injection Control Pressure Sensor)

- The IPR and ICP are both installed into the high pressure pump cover, beneath the turbocharger turbine inlet pipes.

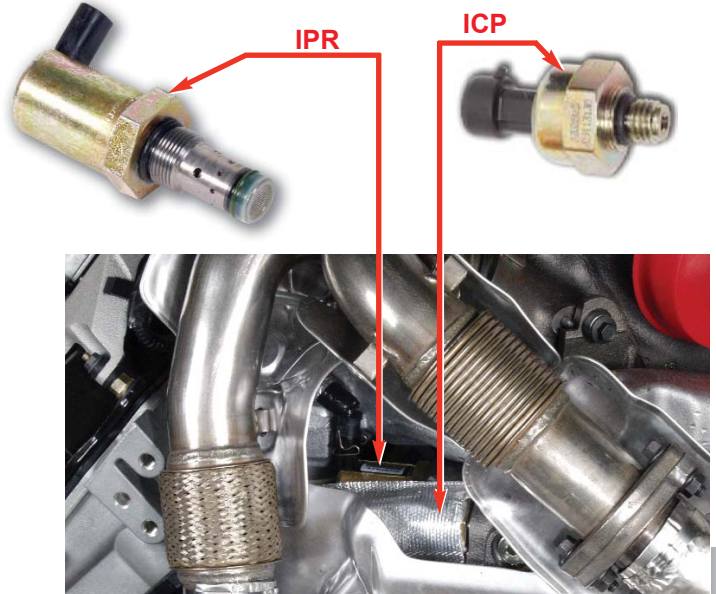

High Pressure Oil Rail with AWA Feature

- The high pressure oil rail has special AWA (Acoustic Wave Attenuation) features to dampen hydraulic noises.
- To accomplish this an AWA fitting is placed in the center of the high pressure oil rail and two specially designed end caps are used.

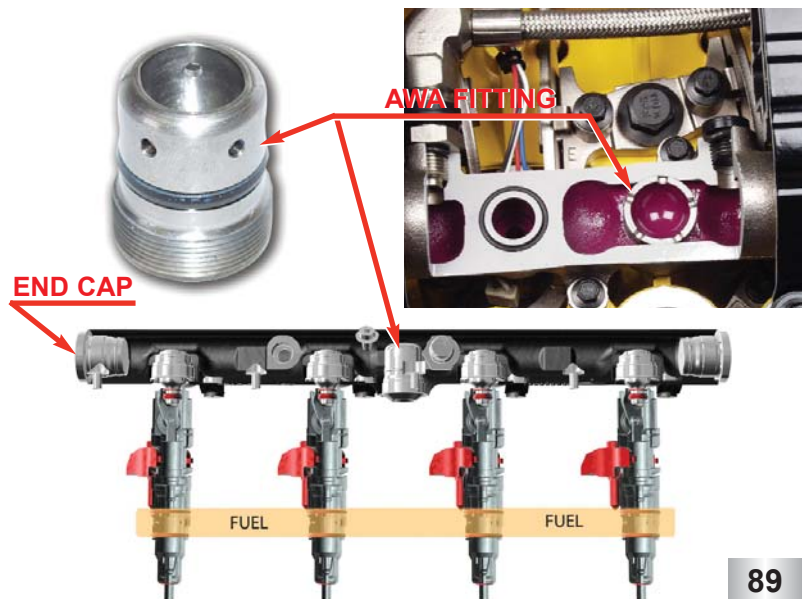

Fuel Injector Features

- Digital Valve
- 48 Volts
- 20 Amps/coil
- Short Coil On Times
- Self extracting hold down clamp

90

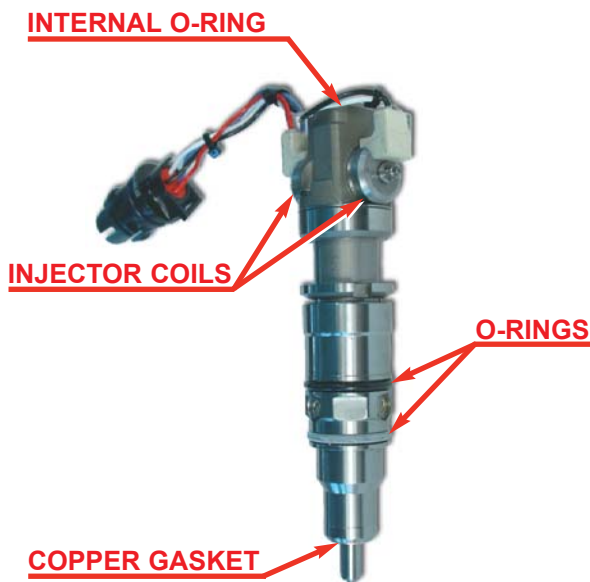

91

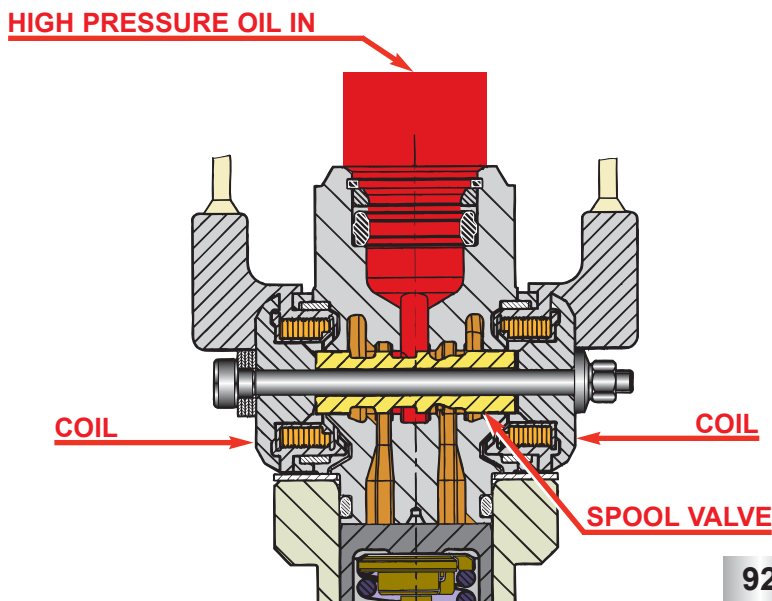

92

Fuel Injector Features

- The injector uses two (2) 48 volt 20 amp coils to control a spool valve that directs oil flow in and out of the injector.
- The injector coils are turned on for approximately 800 μ sec (micro second or millionth of a second).
- No special tools are needed to remove the injectors from their bore. The injector is slowly removed from its bore by removing the hold down clamp bolt.

Injector & O-rings

- The injector has two (2) replaceable o-rings on the outside of the body, one (1) internal non-replaceable o-ring in the top of the injector, and one (1) replaceable copper combustion gasket on the tip of the injector.
- The injector's two (2) coils have a single four (4) pin connector that passes through the rocker arm carrier.

Injector Coils & Spool Valve

- There is an open coil and a close coil on the injector that move the spool valve from side to side using magnetic force.
- The spool valve has two positions, when the valve is in the open position it allows oil to flow from the high pressure oil rail into the injector.
- When the valve is in the closed position it allows oil to drain from the injector back to the crankcase.
- The total movement of the valve is only .017".

FUEL MANAGEMENT SYSTEM

Intensifier Piston

- When the spool valve is in the open position, high pressure oil is allowed to enter the injector and pushes the intensifier piston and plunger downward.
- Since the intensifier piston is 7.1 times greater in surface area than the plunger, the injection force is also 7.1 times greater at the plunger than what the injection control pressure (ICP) is.

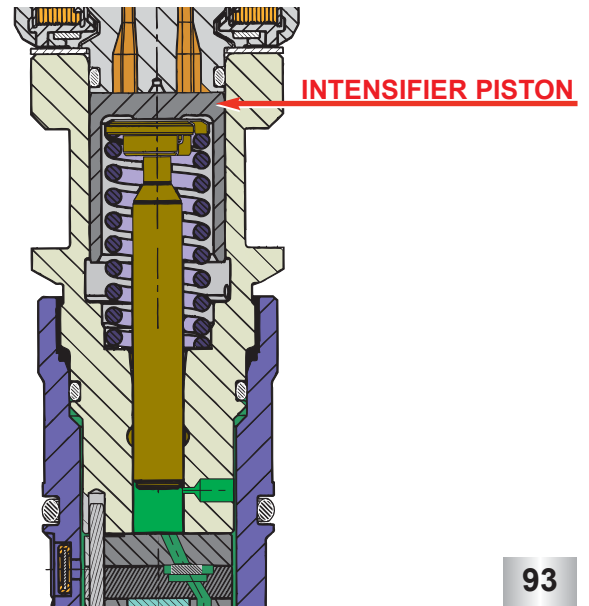

93

Plunger & Barrel

- The bottom of plunger and barrel of the injector is where the fuel injection pressure is built.
- When the plunger is pushed downward by the intensifier piston, it increases the fuel pressure in the barrel 7.1 times that of the ICP pressure.
- The plunger is coated with a tungsten carbide coating to reduce the possibility of scuffing and poor performance.

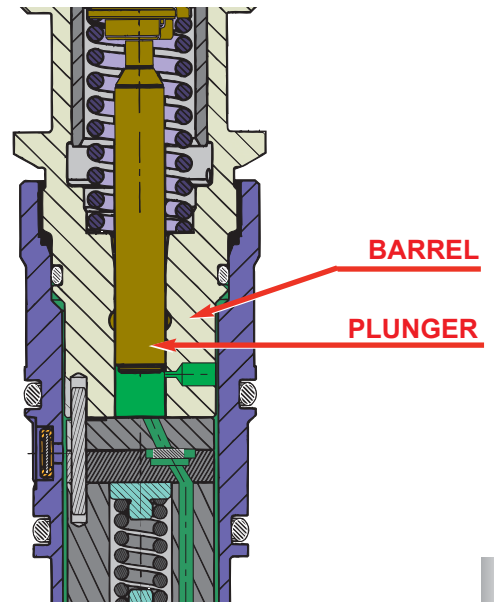

94

Injection Nozzle

- The injection nozzle needle is an inwardly opening type which lifts off its seat when pressure overcomes the VOP (Valve Opening Pressure) of approximately 3100 psi.
- Fuel is atomized at high pressure through the nozzle tip.

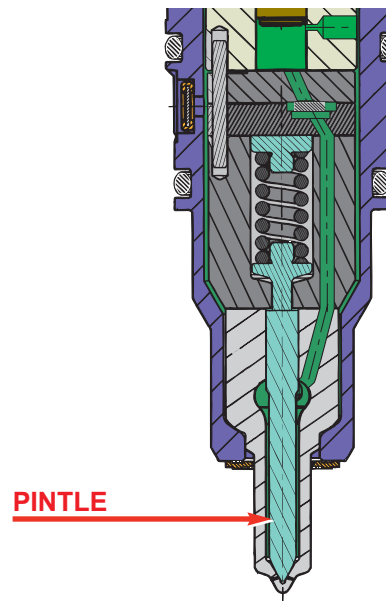

95

Three Stages of Injection

- Fill
- Main Injection
- End of Main Injection

96

Stages of Injection

- The injection cycle has three (3) stages.
- Fill.
- Main injection.
- End of main injection.
- During some conditions the injector will perform all three steps of the injection cycle two times per firing cycle. This is called pilot injection.

Fill Cycle

- During the fill stage, the spool valve is in the closed position.
- High pressure oil from the oil rail is dead headed at the spool valve.
- Low pressure fuel fills the port below the plunger.
- The needle control spring holds the needle on its seat so that fuel can not enter the combustion chamber.

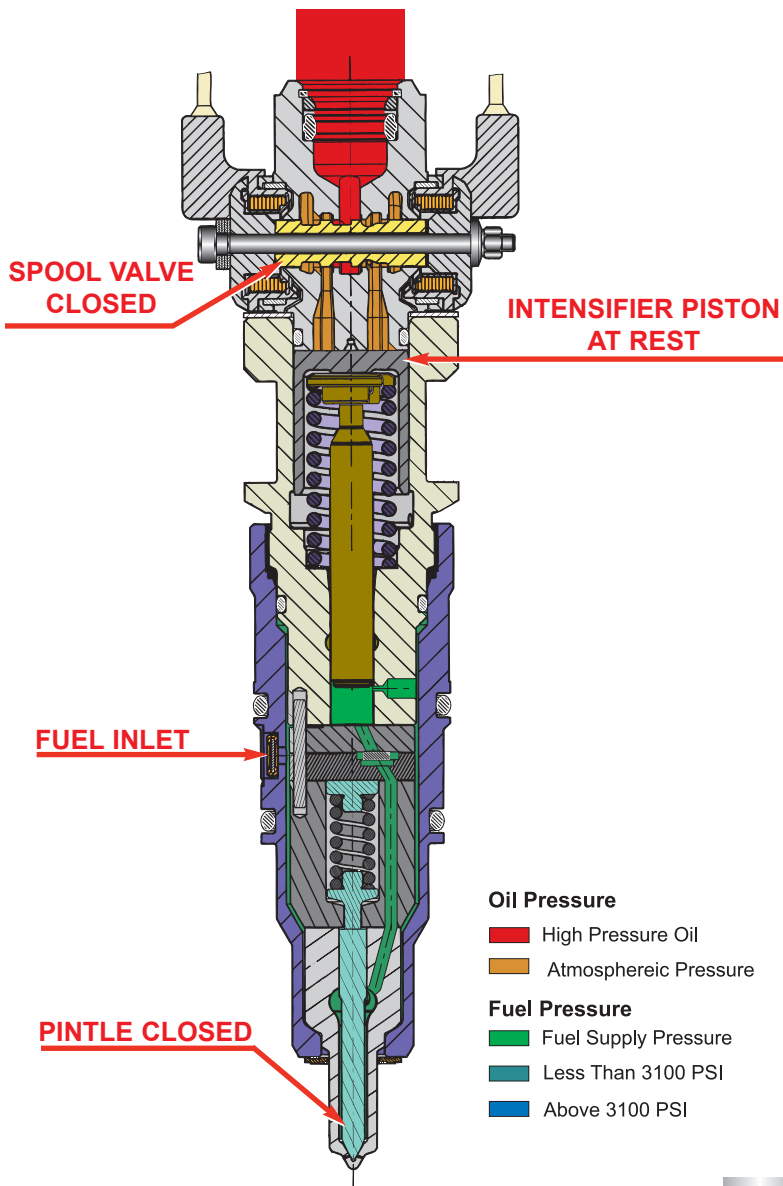

97

FUEL MANAGEMENT SYSTEM

Main Injection Step 1

- Pulse width controlled current energizes the open coil, magnetic force moves the spool valve to the open position.
- High pressure oil flows past the spool valve into the intensifier piston chamber.
- Oil pressure overcomes the intensifier piston spring force and the intensifier starts to move.
- Fuel inlet check ball seats due to an increase of fuel pressure under the plunger.
- Fuel pressure starts to build once the plunger passes the fuel spill port of the barrel.
- Force on the nozzle needle begins to build.

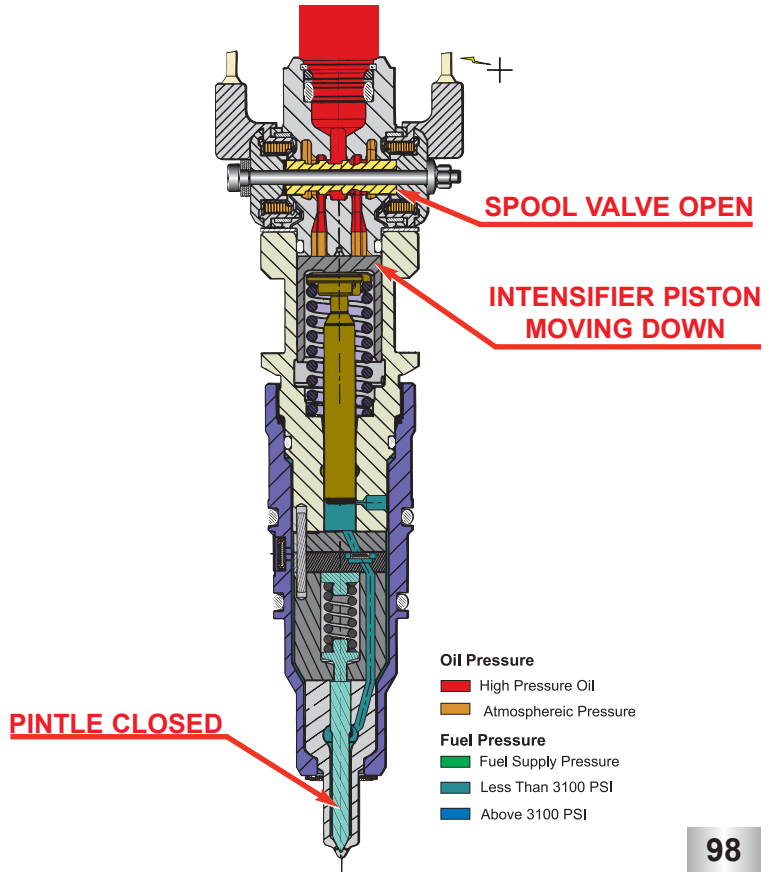

98

Main Injection Step 2

- The pulse width controlled current is shut off after 800 μ sec (micro second or millionth of a second), but the spool remains in the open position.
- High pressure oil from the rail continues to flow past the spool valve.
- The intensifier piston and plunger continue to move and pressure increases in the barrel.
- When fuel pressure rises above the VOP (Valve Opening Pressure) of about 3100 psi, the nozzle needle lifts off of its seat and injection begins.

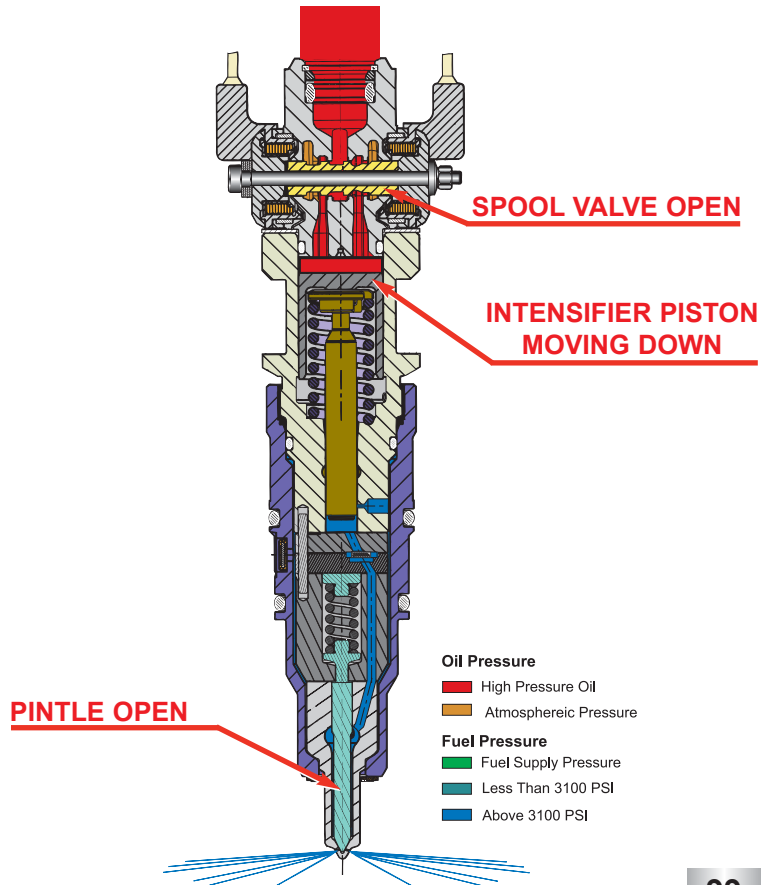

99

FUEL MANAGEMENT SYSTEM

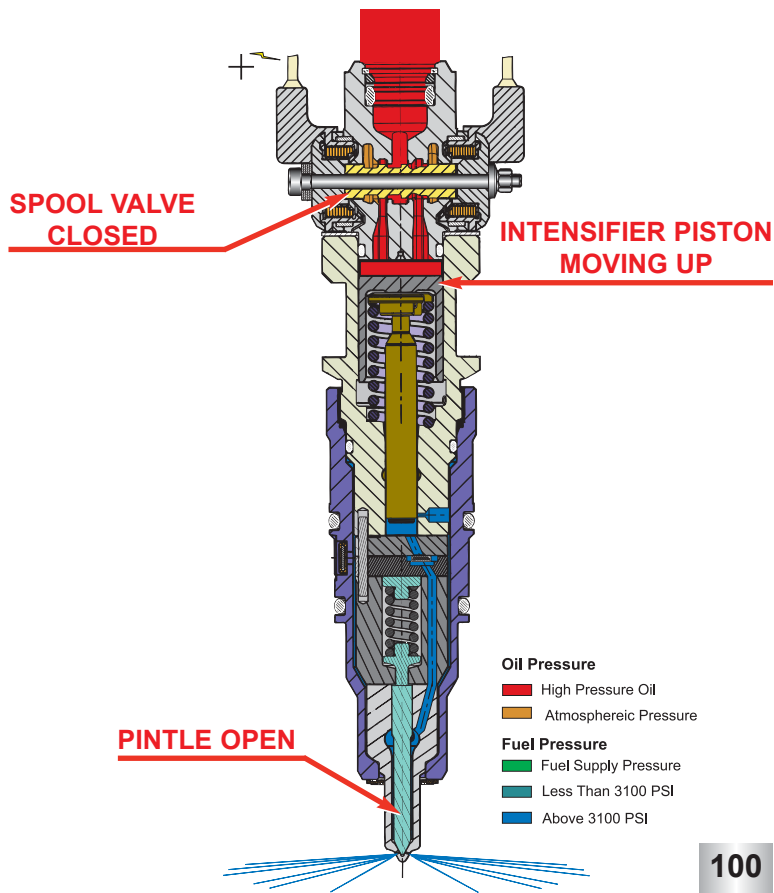

100

End of Main Injection Step 1

- When the IDM (Injector Drive Module) determines that the correct injector on time has been reached (meaning that the correct amount of fuel has been delivered), it sends a pulse width controlled current to the close coil of the injector.
- The current energizes the close coil. Magnetic force moves the spool valve to the closed position.
- High pressure oil is dead headed against the spool valve.

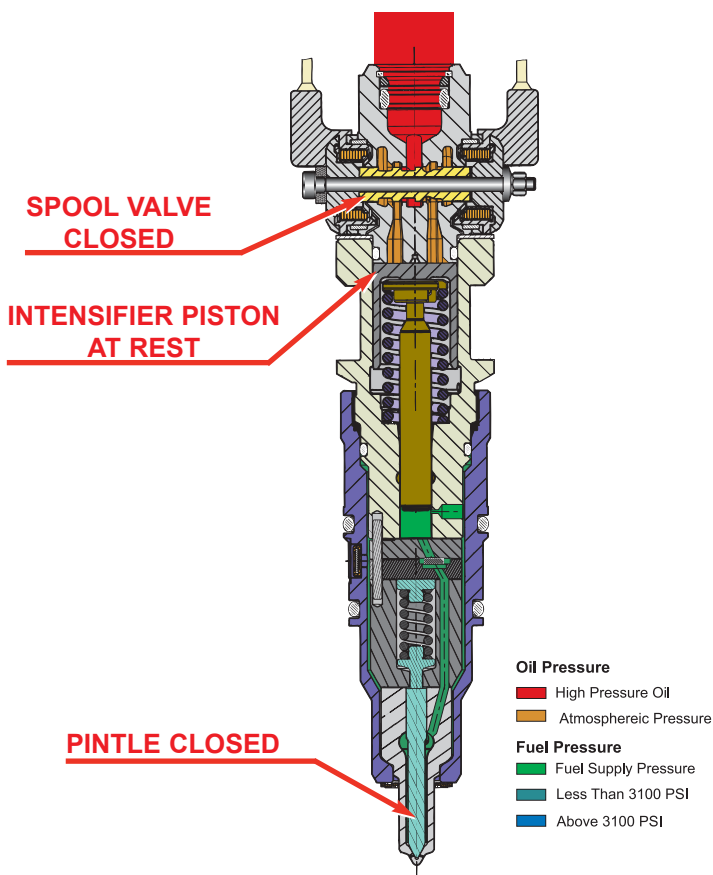

101

End of Main Injection Step 2

- The pulse width controlled current is shut off after 800 μ sec (micro seconds or millionth of a second), but the spool remains in the closed position.
- The intensifier piston and plunger begin to return to their initial position.
- Oil above the intensifier piston flows past the spool valve through the exhaust ports.
- Fuel pressure decreases until the nozzle needle control spring forces the needle back onto its seat.

**This page intentionally
left blank**

Electrical Components

- Sensors
- Actuators
- PCM
- FICM
- Glow plug System

102

Generation II Electrical Components Overview

- The PCM uses information from the sensors to decide which commands to send to the FICM, the actuators, and the glow plug system.

Sensor Overview

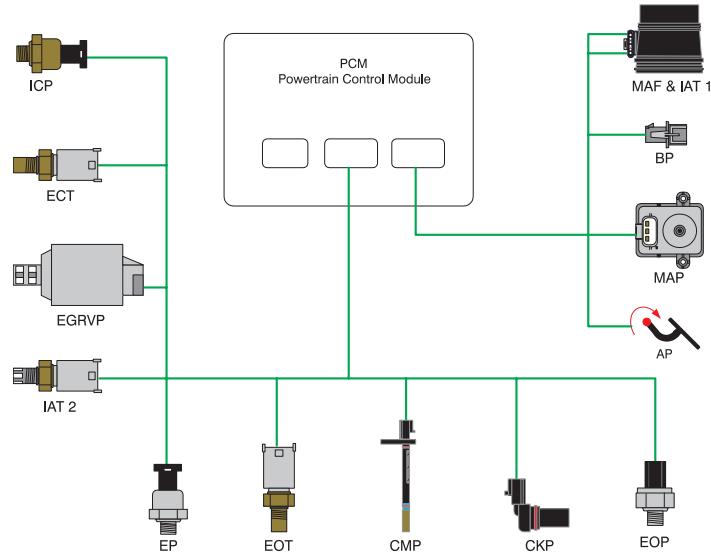

103

Sensors Overview

- The PCM sends a V_{ref} of 5.0 volts to the engine sensors except for CMP and CKP which generate voltage through the collapse of a magnetic field.
- The PCM uses 5 volts as the reference voltage to maintain consistency throughout all operating conditions.
- The V_{ref} is conditioned by the sensors then returned to the PCM for use in determining the fueling strategy.

ELECTRICAL COMPONENTS

Accelerator Position Sensor - Three Track Pedal

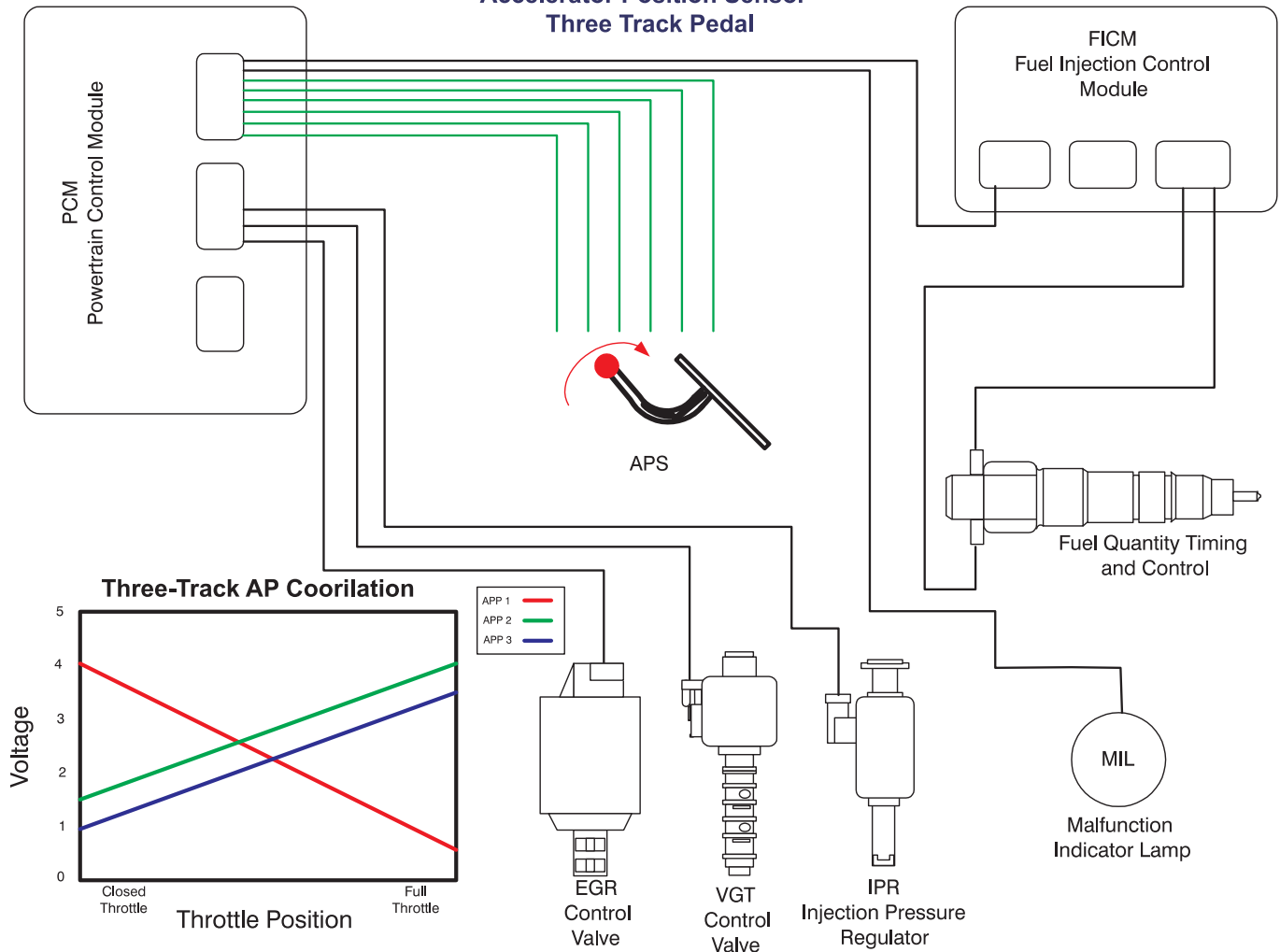

AP (Accelerator Pedal Position)

- The AP (Accelerator Pedal) is a three track pedal. The AP incorporates three potentiometers. Through out the movement of the AP the resistance values of the three potentiometers must agree. During the movement of the AP if one of the three potentiometer readings do not agree, the check engine light will illuminate and the vehicle will continue to perform as normal. If two signals from the AP are lost the PCM will allow the engine to idle only and illuminate the check engine light.
- The three-track pedal is a safety feature. The three track pedal takes the place of the Idle Validation Switch allowing for limited system failure and still maintaining performance.



ELECTRICAL COMPONENTS

Barometric Pressure Sensor

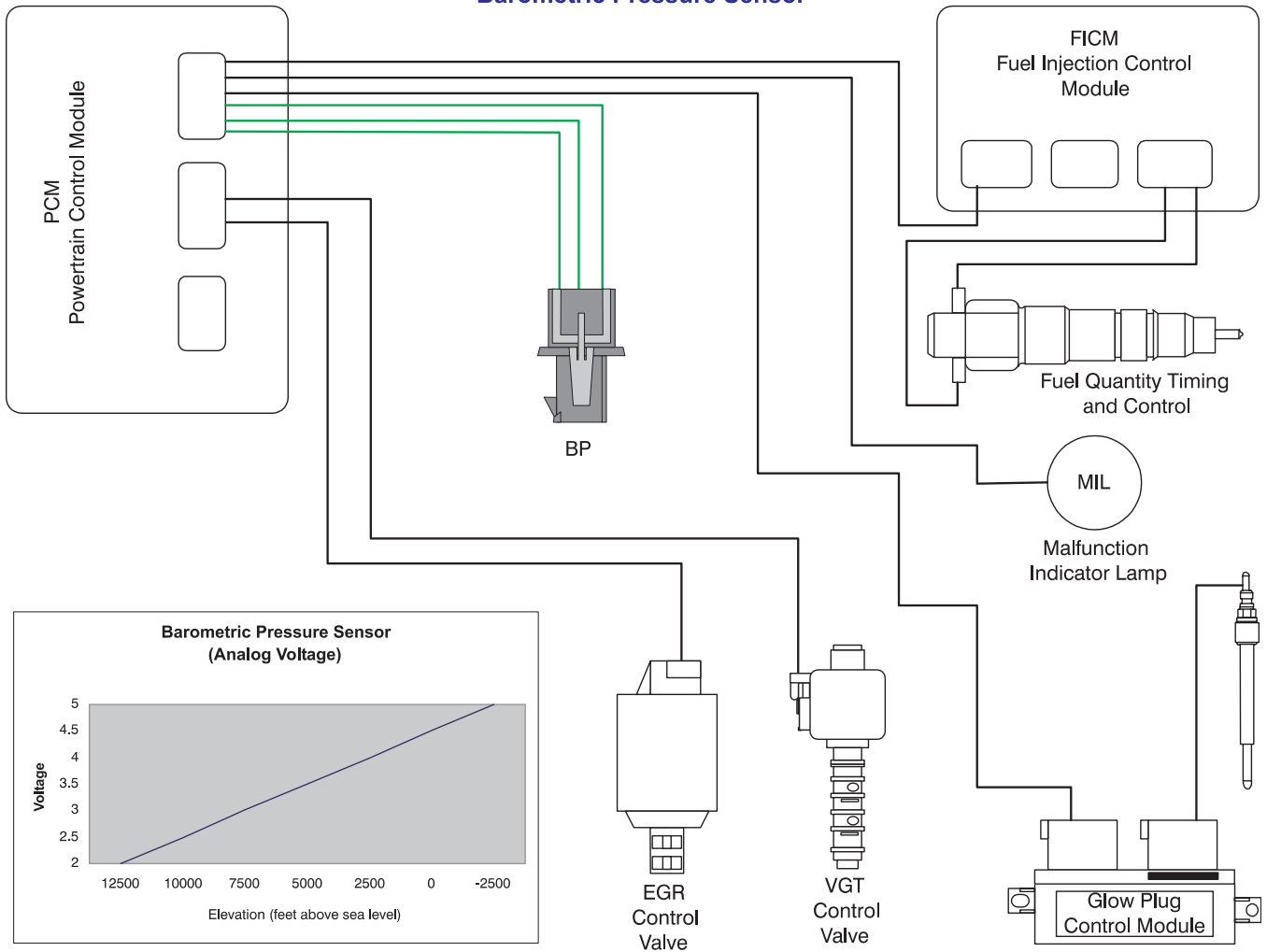

105

Baro (Barometric Pressure)

- The BP sensor is a three (3) wire variable capacitance sensor.
- The PCM supplies a 5 volt reference signal which the BP sensor uses to produce a linear analog voltage signal that indicates pressure.
- The primary function of the BP sensor is to provide altitude information so that the PCM can adjust timing, fuel quantity, glow plug on time, and VGT control.



ELECTRICAL COMPONENTS

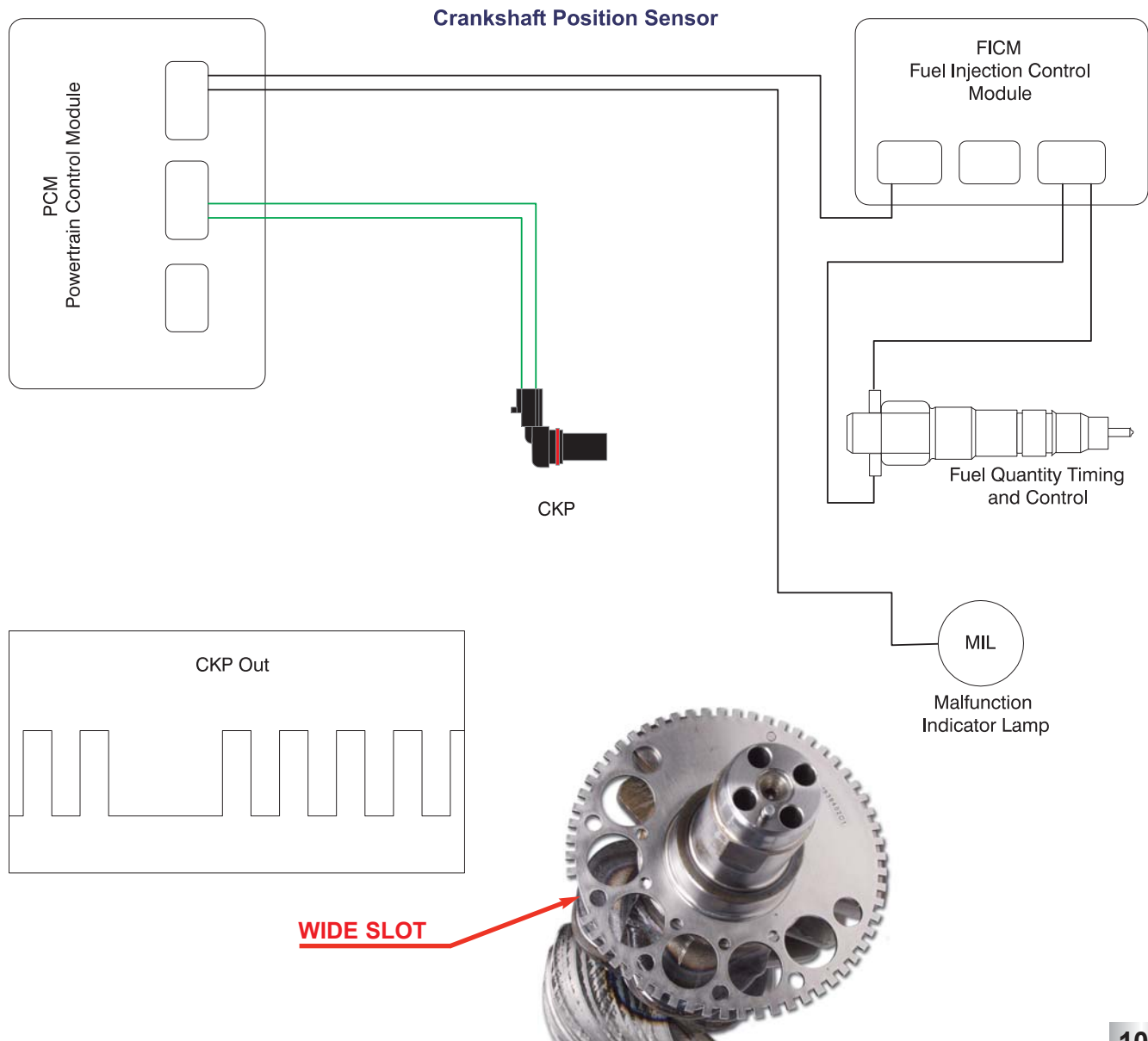

106

CKP (Crankshaft Position)

- The crankshaft position signal source is a magnetic pickup sensor mounted in the right front side of the engine block.
- The sensor reacts to a target wheel positioned on the crankshaft. The target wheel is a 60 minus 2 tooth steel disk with 58 evenly spaced teeth and a slot that's width is equivalent to removing 2 teeth (minus 2 slot) that is the SYNC gap.
- The sensor will produce pulses for each tooth edge that breaks the magnetic field created by the permanent magnet that is in the

end of the sensor.

- Crankshaft speed is derived from the frequency of the CKP sensor signal.
- Crankshaft position can be determined by the synchronization of the CMP peg signal to the CKP minus 2 slot signal.
- Diagnostic information on the CKP input signal is obtained by performing accuracy checks on frequency, and/or duty cycle with software strategies.
- The PCM needs both the CKP and CMP signal to calculate engine speed and position. The CKP

creates a signal that relates to crankshaft speed and position relative to TDC (Top Dead Center). The CMP creates a signal relative to which stroke the piston is currently on (compression or exhaust).



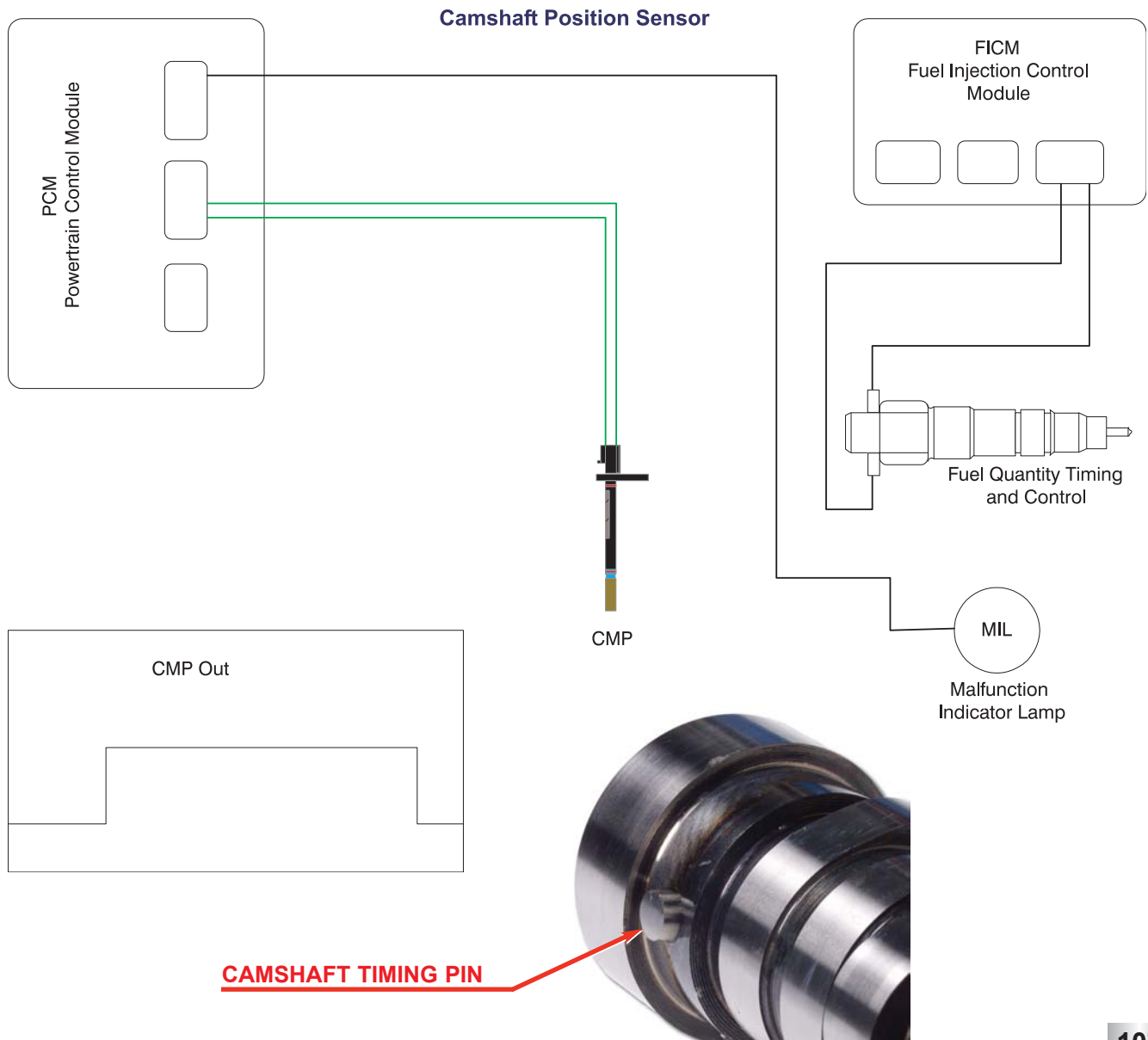

CMP (Camshaft Position)

- The camshaft position signal source is a magnetic pickup sensor mounted on the left front side of the engine block.
- The sensor reacts to a peg, pressed into the camshaft at the front of the engine.
- The peg will pass the sensor once per camshaft revolution, the sensor will produce a single pulse correspondingly.
- Camshaft speed is derived from the frequency of the CMP sensor signal.
- Diagnostic information on the CMP input signal is obtained by performing accuracy checks on signal levels, frequency, and/or duty cycle with software strategies.
- The ECM needs both the CKP and CMP signal to calculate engine speed and position. The CMP creates a signal that the PCM uses to indicate a particular bank.
- The CMP contains a permanent magnet which creates a magnetic field, when the magnetic field is broken by the peg on the camshaft a signal is created.
- A conditioned CMPO (Camshaft Position Output) is sent from the PCM to the FICM so that the FICM can perform fueling calculations.
- The PCM conditions the signal and sends it out as TACH signal for body builder use.



ELECTRICAL COMPONENTS

Engine Coolant Temperature Sensor

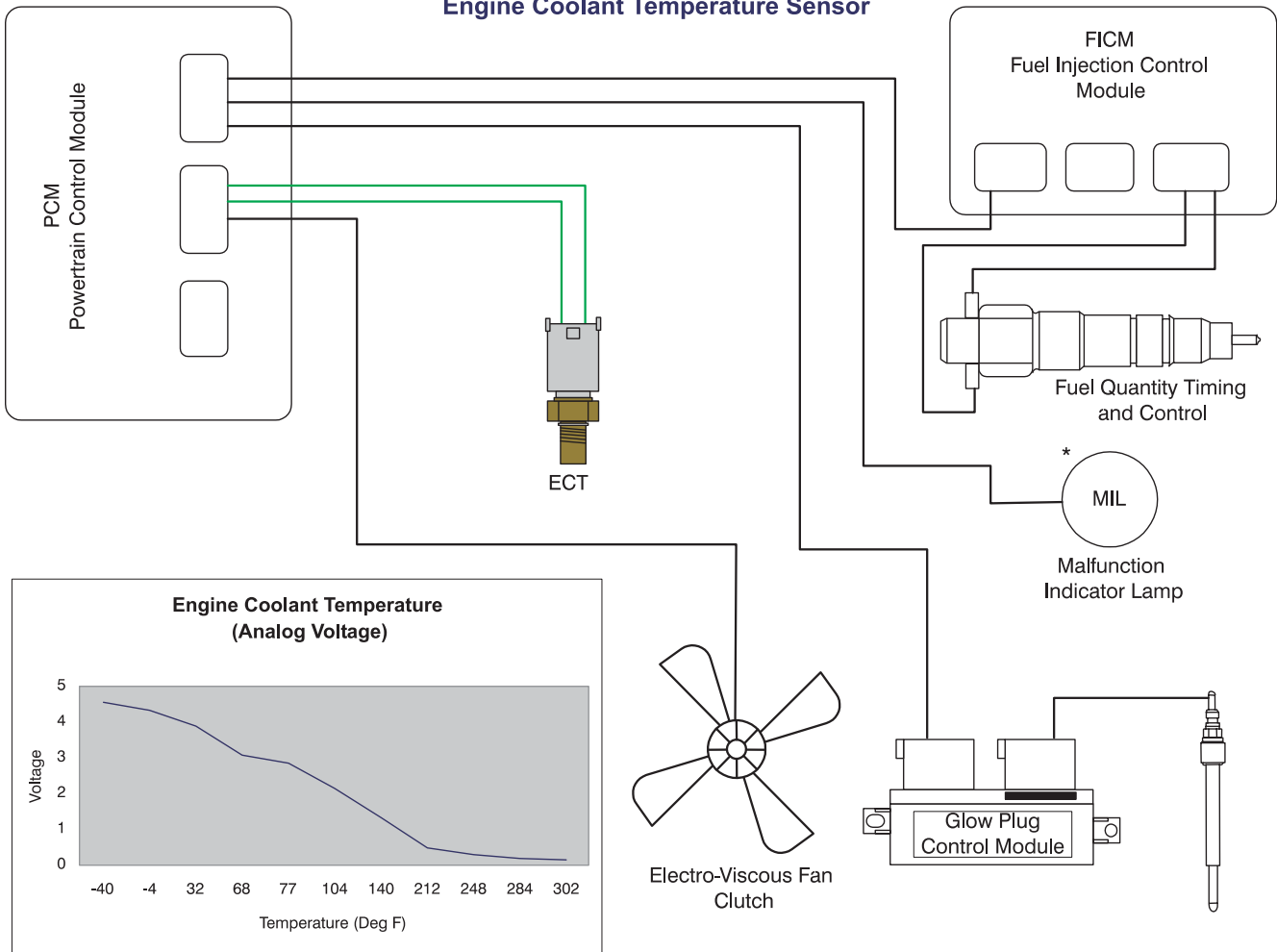

* 49 State Only

108

ECT (Engine Coolant Temp.)

- The ECT sensor is a two (2) wire thermistor sensor.
- The PCM supplies a 5 volt reference signal which the ECT sensor uses to produce an analog voltage.
- The ECT sensor changes resistance when exposed to different temperatures.
- When the temperature of the coolant decreases, the resistance of the thermistor increases and the signal voltage increases.
- When the temperature of the coolant increases, the resistance of the thermistor decreases and the signal voltage decreases.

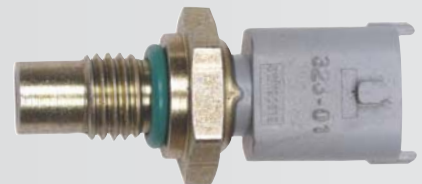

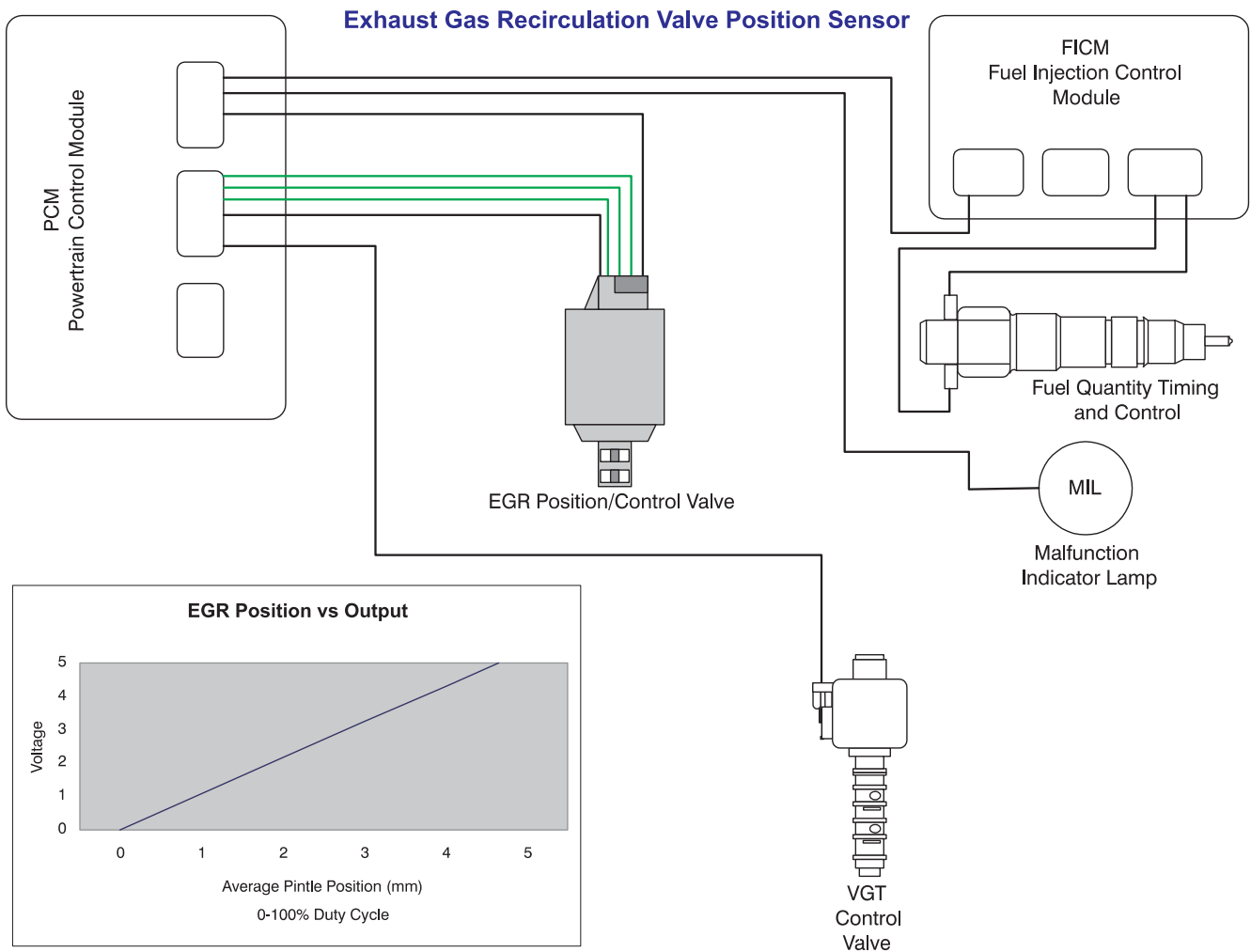

EGRVP (Exhaust Gas Recirculation Valve Position)

- The EGRVP sensor is a three (3) wire potentiometer type sensor.
- The PCM supplies a 5 volt reference voltage that the EGRVP uses to produce a linear analog voltage that indicates the amount of movement of the valve.
- The PCM monitors EGRP as the engine is operating to modulate the EGR valve.
- This is a closed loop function which means that the PCM continuously monitors the EGRVP to ensure proper valve operation.

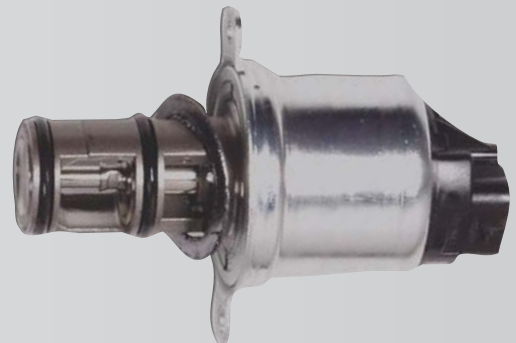

ELECTRICAL COMPONENTS

Engine Oil Pressure Switch

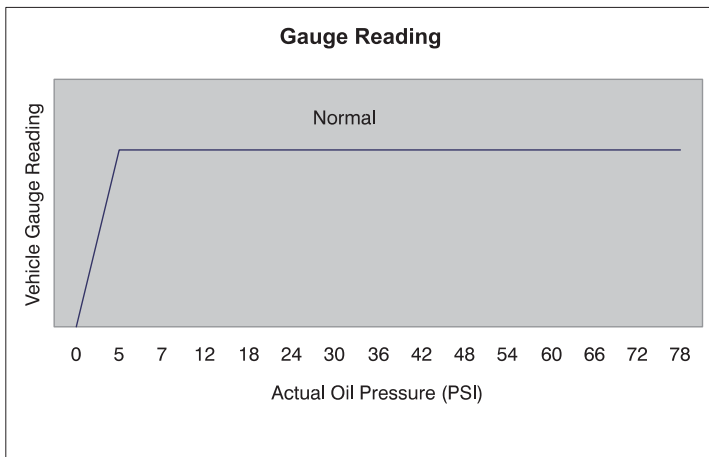
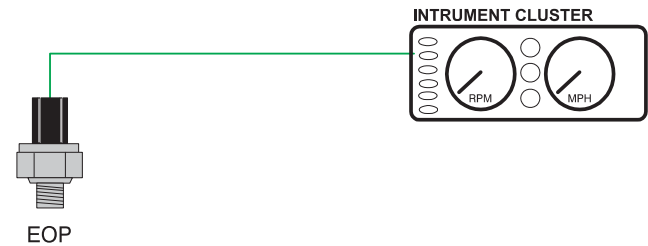

110

EOP (Engine Oil Pressure Switch)

- The EOP (Engine Oil Pressure Switch) is a switch that closes a circuit to ground after engine oil pressure reaches approximately 5-7psi.
- This switch controls the oil pressure gauge on the instrument panel. When pressure is above 7psi the gauge will read normal and if the pressure drops below 6 psi the gauge will show 0.
- The information from the switch is not fed back to the PCM in any way and is to be used as a reference only.



ELECTRICAL COMPONENTS

Engine Oil Temperature Sensor

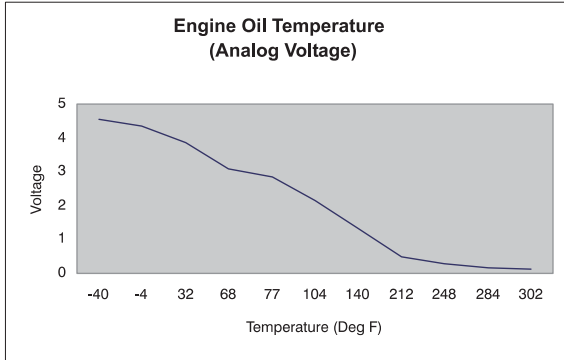
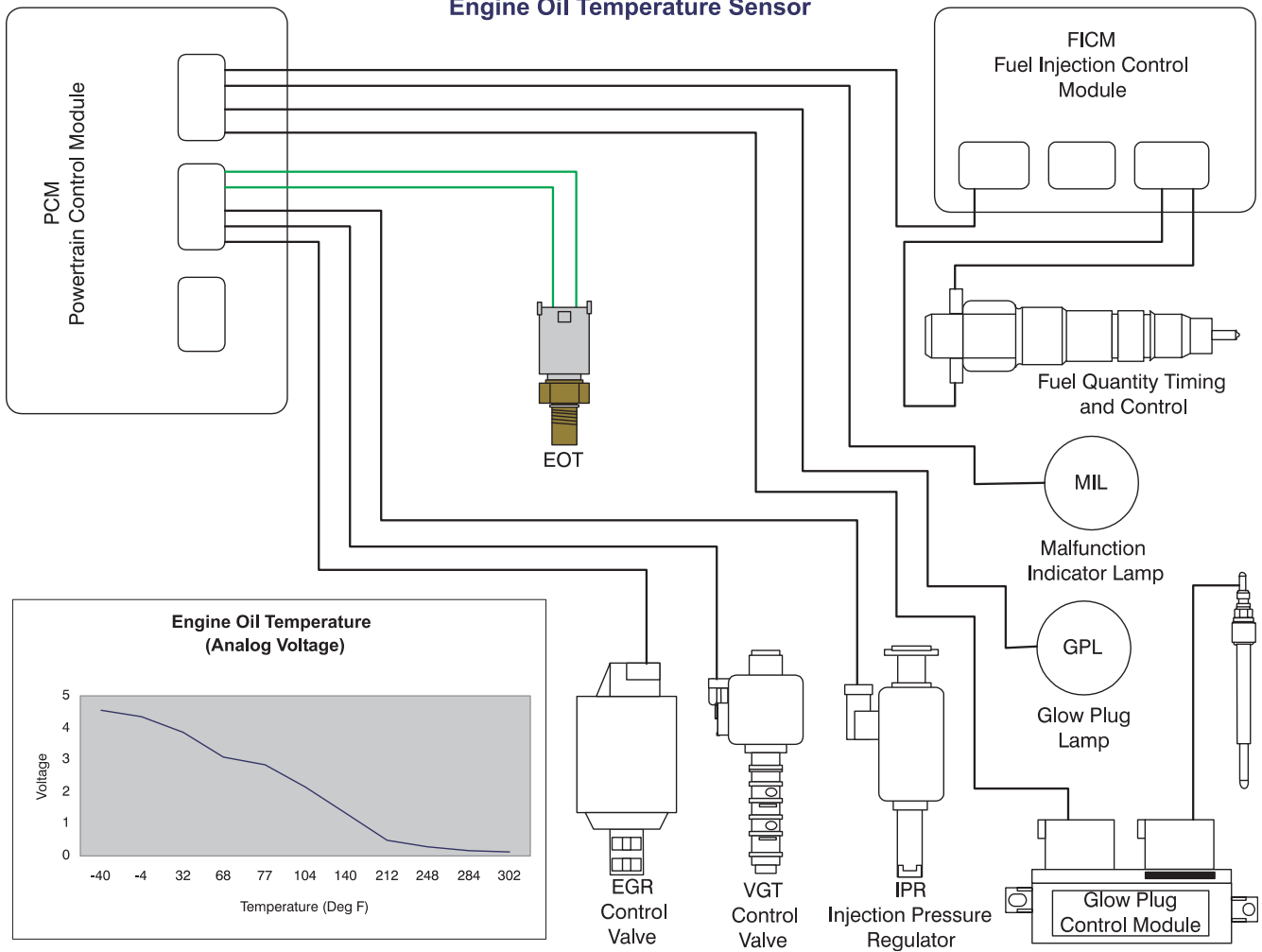

EOT (Engine Oil Temperature)

- The EOT sensor is a two (2) wire thermistor type sensor.
- The PCM supplies a 5 volt reference signal which the EOT sensor uses to produce an analog voltage that indicates temperature.
- The PCM monitors engine oil temperature via the EOT sensor signal to control, EGR, glow plugs, VGT, and fuel quantity and timing throughout the operating range of the engine.
- The EOT signal allows the PCM to compensate for oil viscosity variations due to temperature

changes in the operating environment, ensuring adequate power and torque are available for all operating conditions.

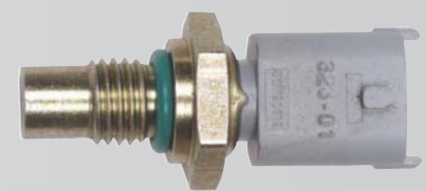

ELECTRICAL COMPONENTS

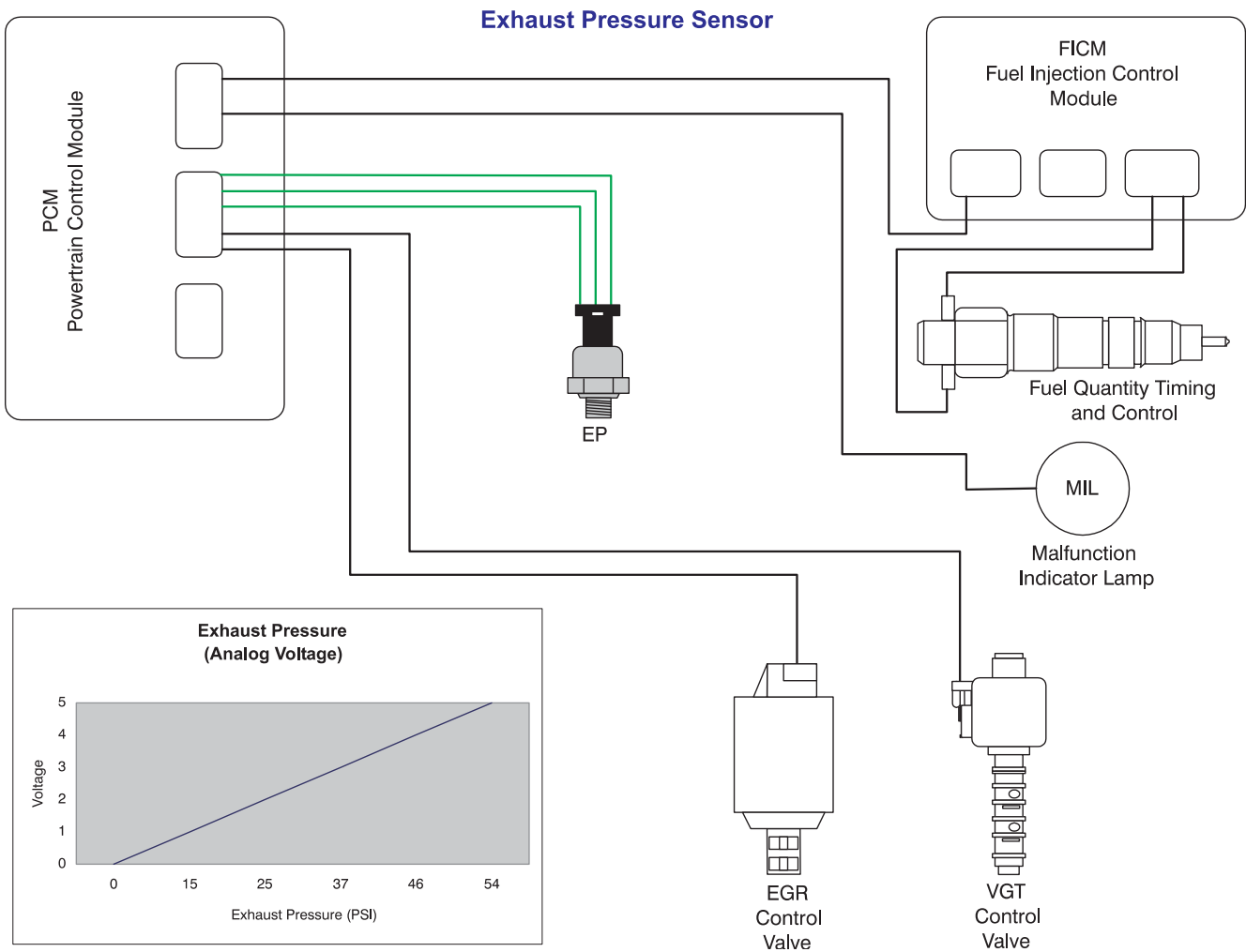

112

EP (Exhaust Pressure)

- The EP sensor is a three (3) wire variable capacitance sensor.
- The PCM supplies a 5 volt reference signal which the EP sensor uses to produce a linear analog voltage that indicates pressure.
- The EP measures exhaust back pressure so that the PCM can control the VGT and EGR system.

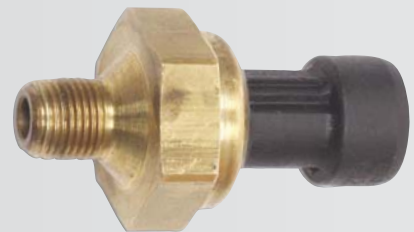

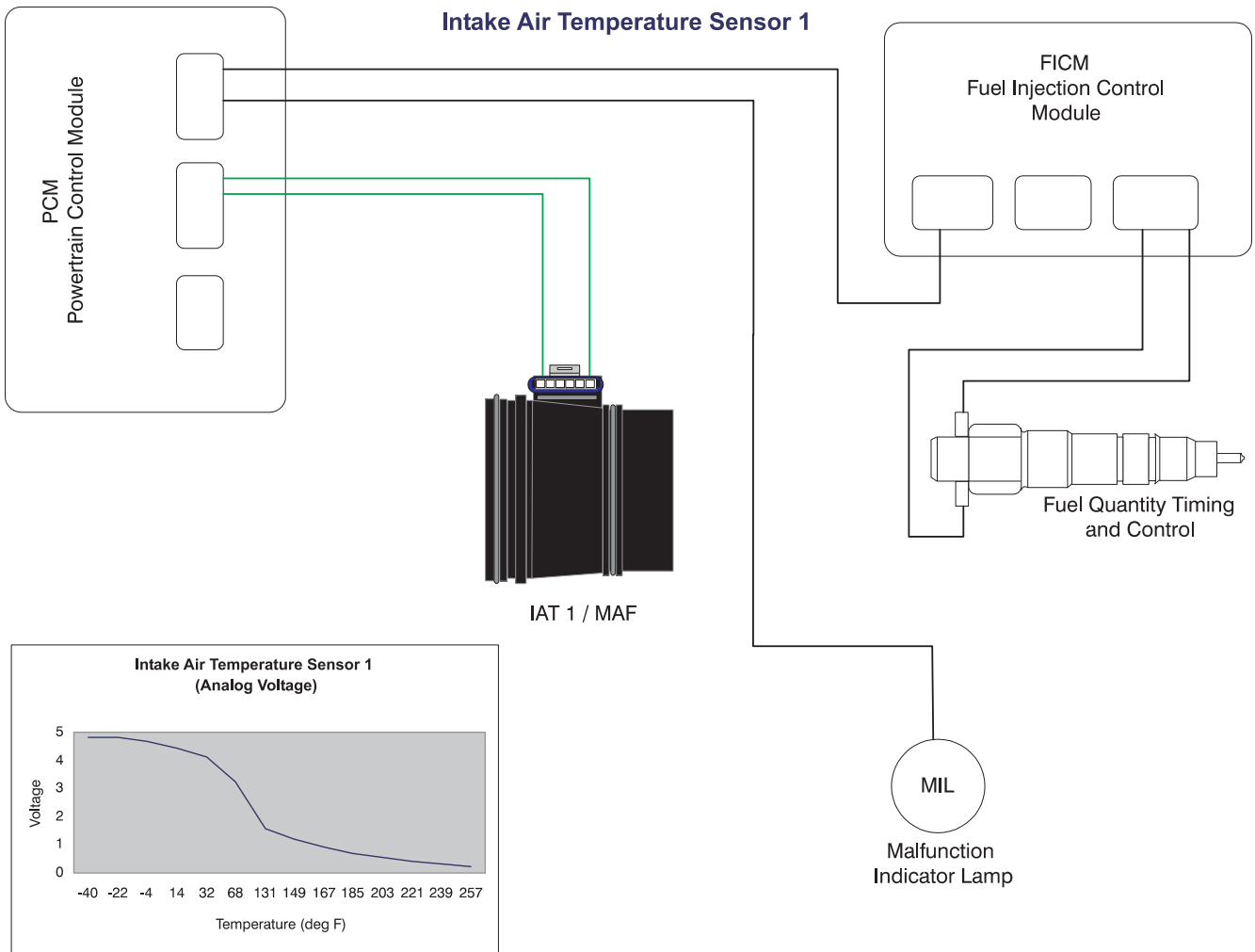

IAT1 (Intake Air Temperature #1)

- The Intake Air Temperature1 (IAT1) sensor is a two wire thermistor sensor that is located inside the Mass Air Flow (MAF) sensor
- The PCM supplies a 5 volt reference signal which the IAT1 uses to produce an analog voltage that indicates the intake air temperature.
- The IAT1 sensor's primary function is to measure intake air temperature to control the timing and fuel rate when cold starting. The continuous monitoring by the IAT1 sensor limits smoke emissions.
- The MAF/IAT1 sensor is mounted in the intake air piping after the air filter.



ELECTRICAL COMPONENTS

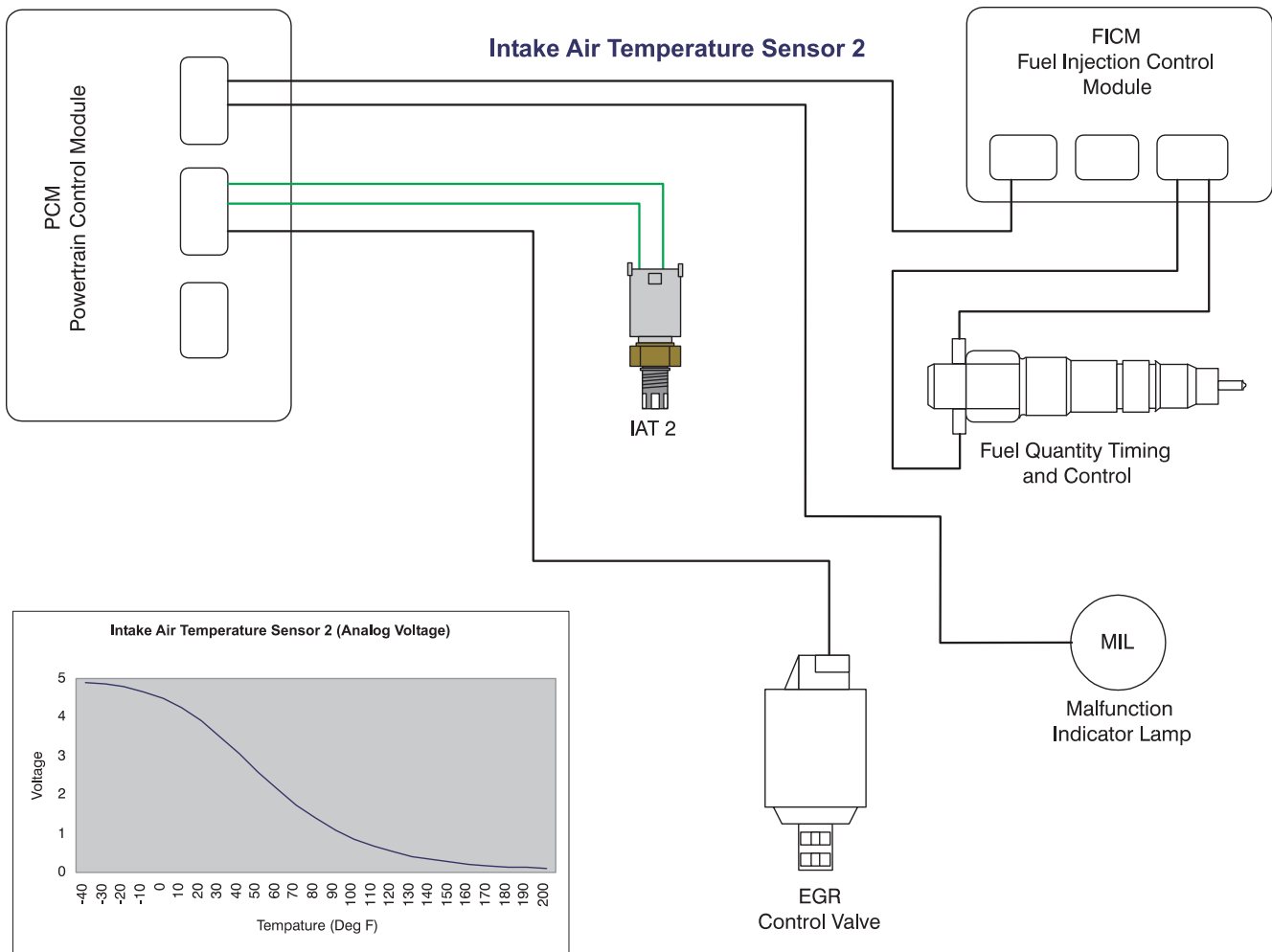

114

IAT2 (Intake Air Temperature #2)

- The IAT2 sensor is a two (2) wire thermistor type sensor.
- The IAT2 sensor changes resistance when exposed to different air temperature.
- When temperature decreases, the resistance of the thermistor increases. This causes the signal voltage to increase.
- When the temperature increases, the resistance of the thermistor decreases. This causes the signal voltage to decrease.
- The primary function of the IAT2 sensor is to provide a feedback signal to the PCM indicating manifold air temperature.
- The PCM supplies a 5 volt reference signal which the IAT2 sensor uses to produce an analog voltage that indicates temperature.
- The PCM monitors the IAT2 signal to determine if the temperature is satisfactory.
- During engine operation, if the PCM recognizes that the IAT2 signal is lower or higher than the expected value it will set a Diagnostic Trouble Code (DTC) and illuminate the amber malfunction indicator lamp on the dash.

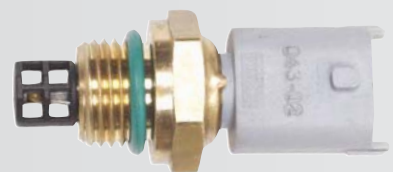

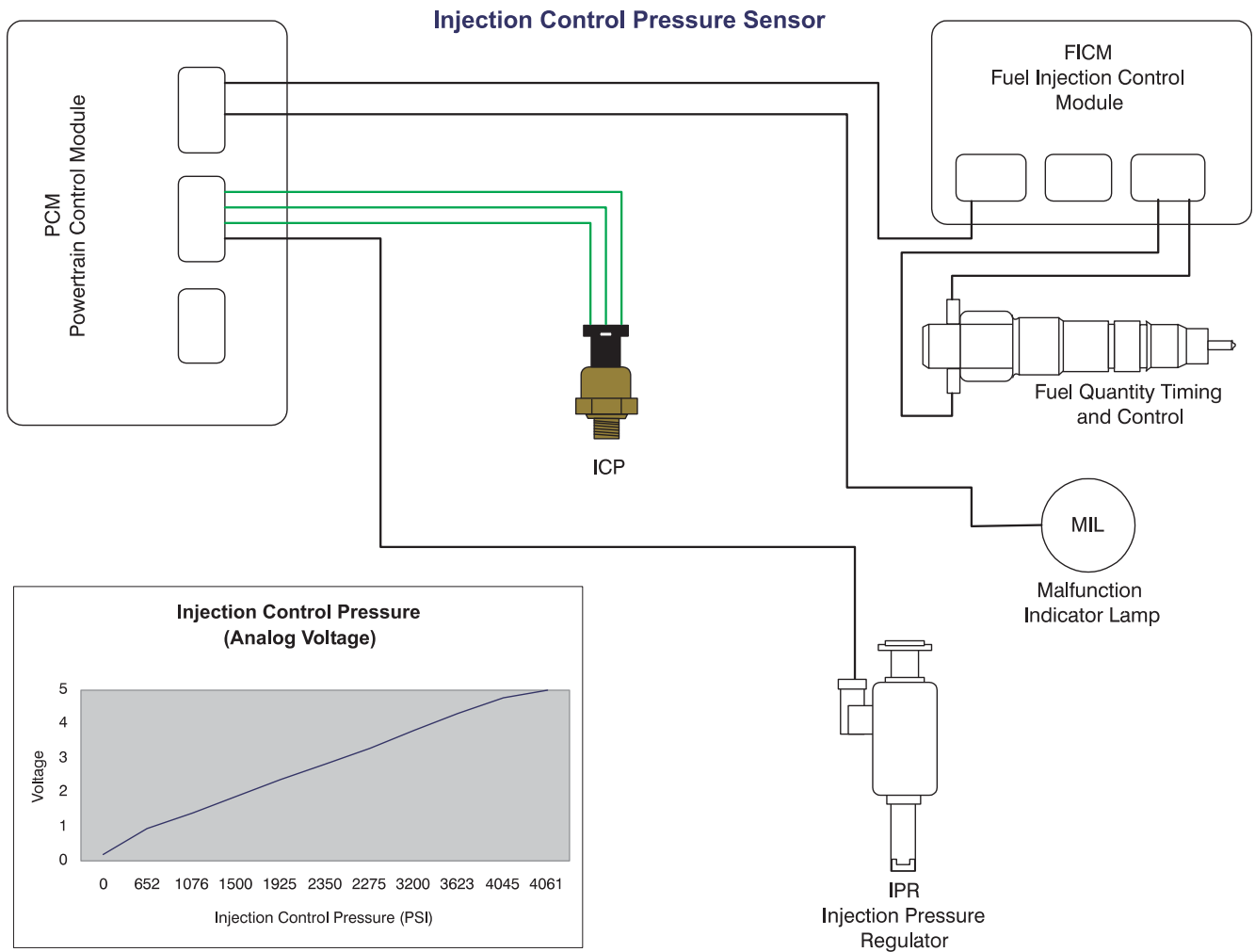

ICP (Injection Control Pressure)

- The ICP sensor is a three (3) wire variable capacitance sensor.
- The PCM supplies a 5 volt reference signal which the ICP sensor uses to produce a linear analog voltage that indicates pressure.
- The primary function of the ICP sensor is to provide a feedback signal to the PCM indicating ICP.
- The PCM monitors ICP as the engine is operating to modulate the IPR. This is a closed loop function which means the PCM continuously monitors and adjusts for ideal ICP determined by conditions such as load, speed, and temperature.
- The PCM monitors the ICP signal to determine if the performance of the hydraulic system is satisfactory.
- During engine operation, if the PCM recognizes that the ICP signal is lower or higher than the value the IPR is trying to achieve the PCM will set a Diagnostic Trouble Code (DTC) and illuminate the amber malfunction indicator lamp on the dash.
- The ICP signal from the PCM is one of the signals the FICM uses to command the correct injection timing.

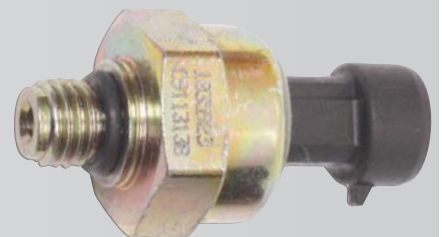

ELECTRICAL COMPONENTS

Mass Air Flow Sensor

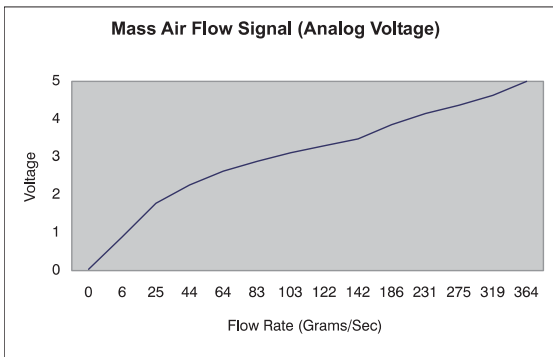
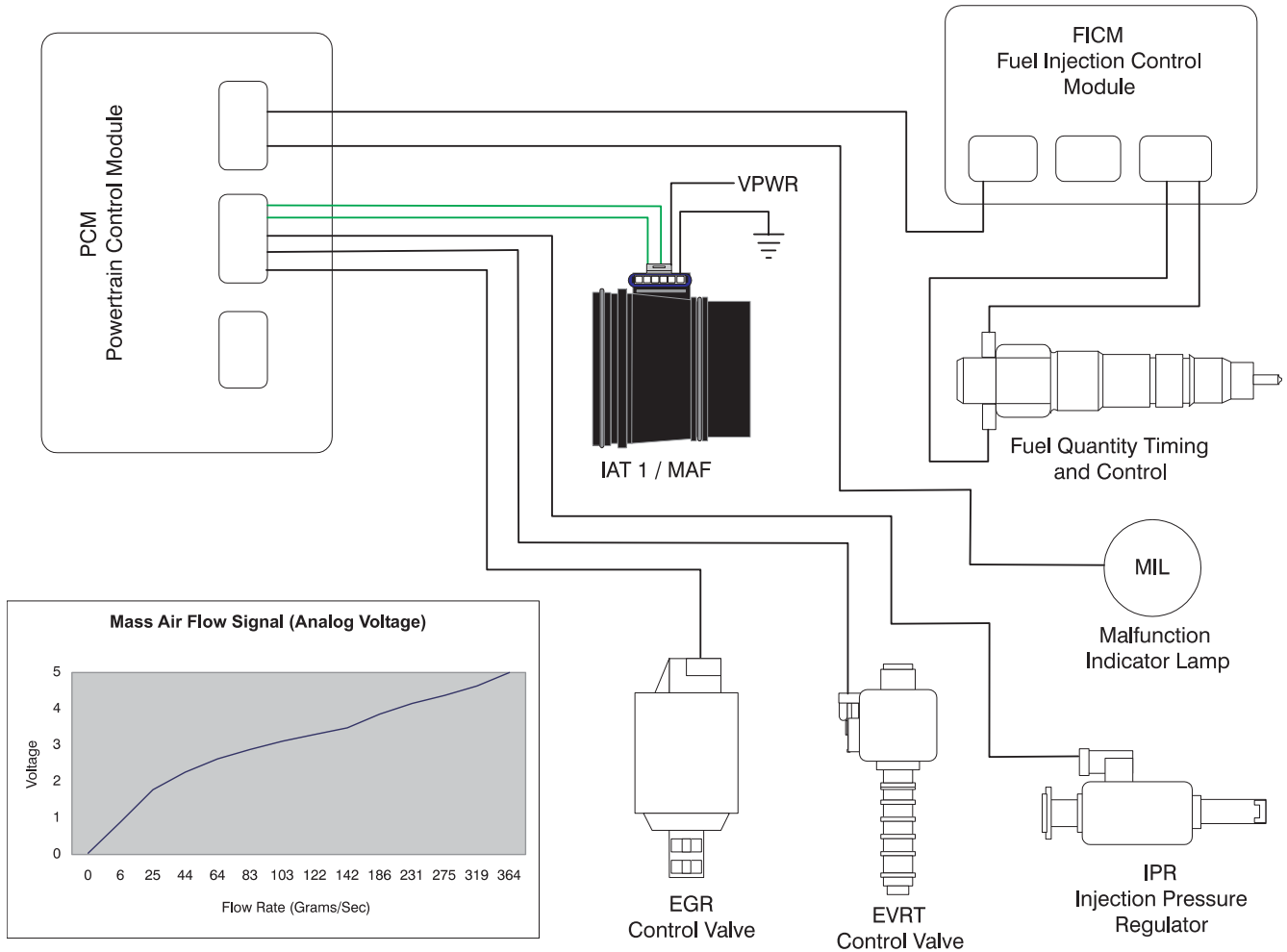

MAF (Mass Air Flow)

- The Mass Air Flow (MAF) sensor uses a hot wire sensing element to measure the amount of air entering the engine. Air passing over the hot wire causes it to cool. This hot wire is maintained at 200°C (392°F) above ambient temperature as measured by a constant cold wire.
- The current required to maintain the temperature of the hot wire is proportional to the air mass flow.
- The MAF sensor then outputs an analog voltage signal to the PCM proportional to the air mass.



ELECTRICAL COMPONENTS

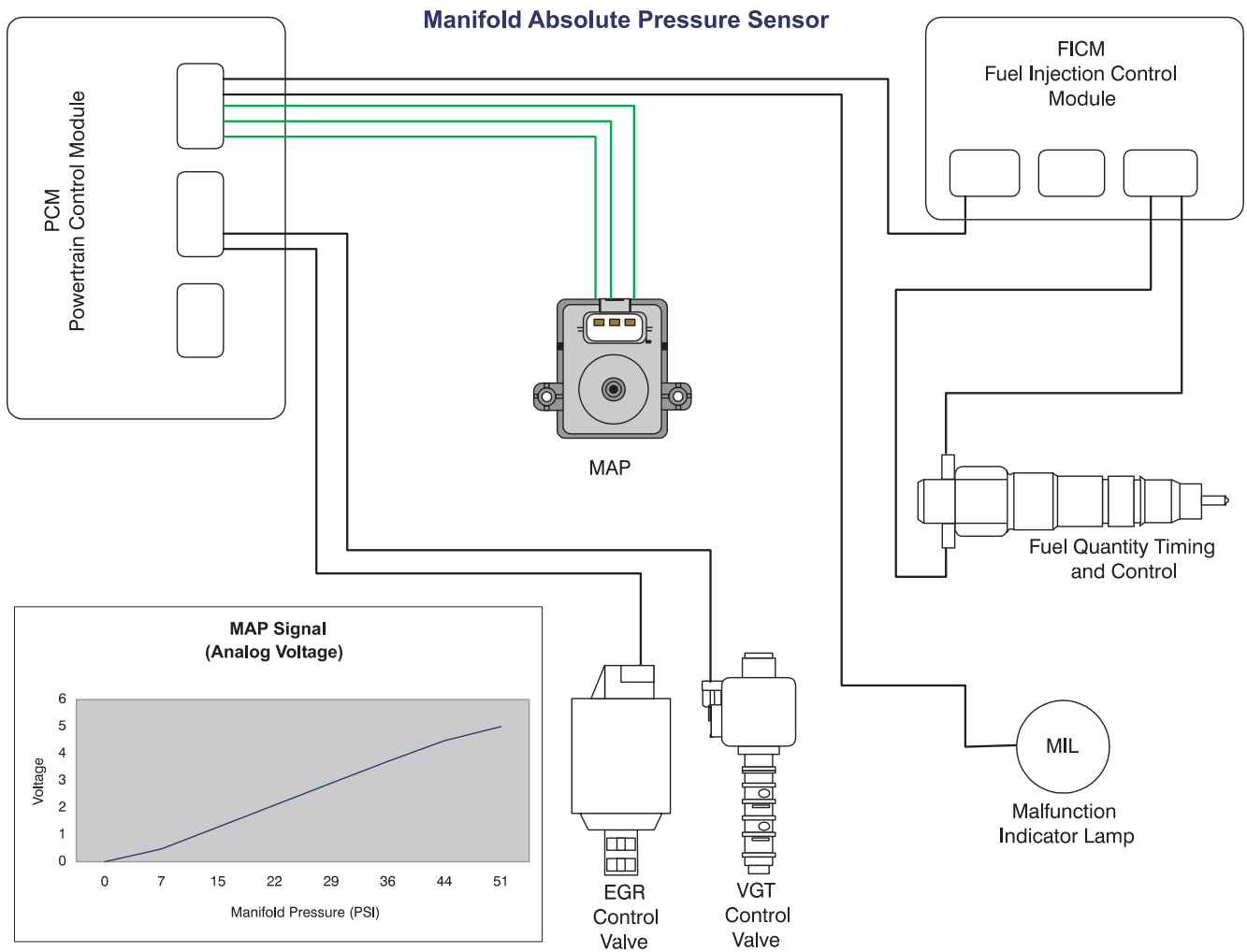

117

MAP (Manifold Absolute Pressure)

- The MAP sensor is a three (3) wire variable capacitance sensor.
- The PCM uses the MAP sensor signal to assist in the calculation of EGR duty cycle.
- The PCM measures the MAP signal to determine intake manifold (boost) pressure.



ELECTRICAL COMPONENTS

Actuators

- Actuators convert electrical output from the PCM to hydraulic, mechanical, or electronic work.
- The 6.0L *Power Stroke* uses four (4) actuators: Injection Pressure Regulator, Exhaust Gas Recirculation Valve, Variable Geometry Turbocharger Control Valve, and Glow Plug Control module.

IPR (Injection Pressure Regulator)

- The IPR (Injector Pressure Regulator) is a duty cycle controlled valve that the PCM uses to control ICP (Injection Control Pressure).
- The IPR is a valve that blocks the path to drain for oil coming out from high pressure pump. As duty cycle signal increases at the IPR the restriction to drain increases, thus increasing ICP.
- When the valve is disconnected it is in its open or drain state and the engine should not start.
- The IPR valve also contains the pressure relief valve for the high pressure oil system.

EGR (Exhaust Gas Recirculation) Valve

- The EGR (Exhaust Gas Recirculation) valve is used to mix cooled exhaust gasses with intake air to lower emissions and noise.
- The EGR valve is duty cycle controlled, the higher the duty cycle the more the valve opens.
- When the valve is disconnected it is in its closed state.

Actuators

- Injection Pressure Regulator (IPR)
- Exhaust Gas Recirculation Valve (EGR)
- Variable Geometry Turbocharger Control Valve (VGTCV)
- Glow Plug Control Module (GPCM)

118

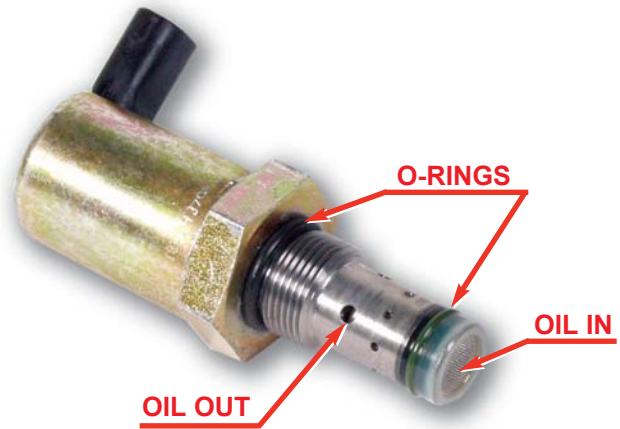

119

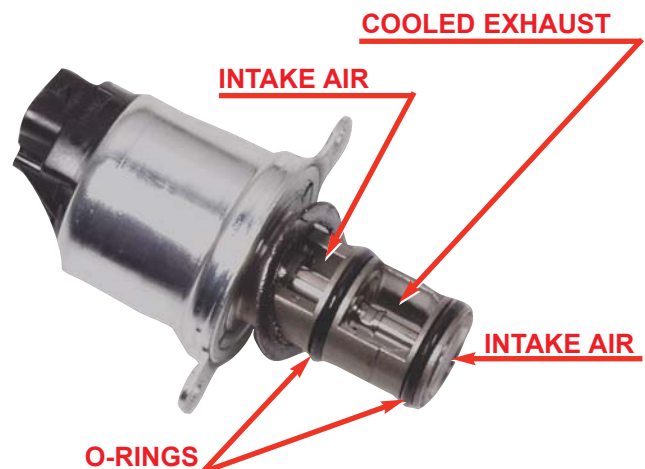

120

ELECTRICAL COMPONENTS

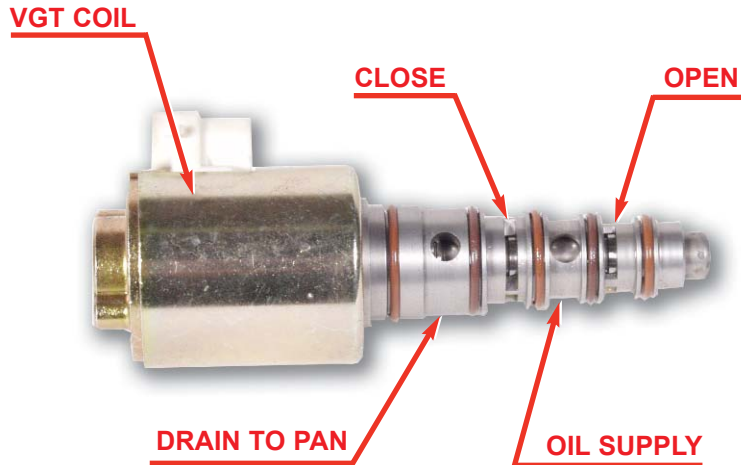

121

VGTCV (Variable Geometry Turbocharger Control Valve)

- The VGTCV (Variable Geometry Turbocharger Control Valve) is a duty cycle controlled valve that directs oil flow to the piston that controls the vanes in the turbocharger.
- The valve controls pressure to both the open and close side of the piston.
- If the valve is disconnected the turbocharger vanes will remain in a open state.

Other Electrical Components

- Fuel Injection Control Module (FICM)
- Powertrain Control Module (PCM)
- Glow Plug System

122

Other Electrical Components

- Other electrical system components include the FICM, PCM, and the glow plug system.

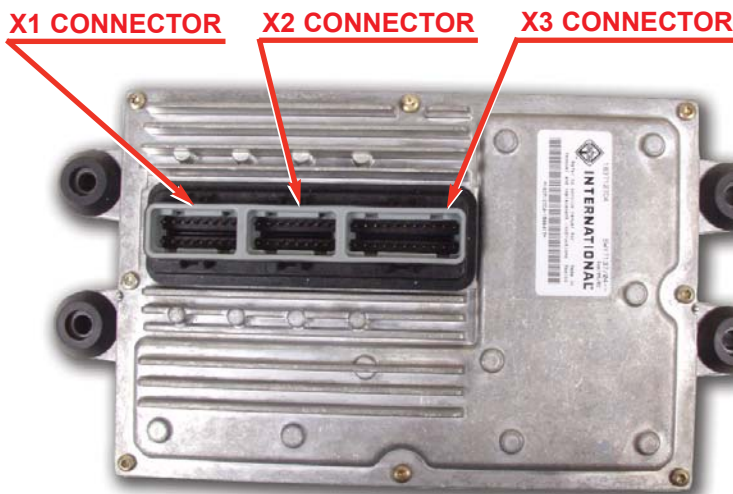

123

FICM (Fuel Injection Control Module)

- The FICM (Fuel Injection Control Module) receives Information from the PCM (like volume of fuel desired, RPM, EOT, ICP and others) and uses those signals to calculate injector start of injection and duration.
- After calculating injector fuel delivery time the IDM sends a 48 volt 20 amp pulse to the correct injector so that the correct amount of fuel will be delivered to the cylinder at the correct time.

ELECTRICAL COMPONENTS

PCM (Powertrain Control Module)

- The Powertrain Control Module (PCM), which is mounted behind the battery on the drivers side inner fender panel, uses sensor inputs to control actuators and send fueling commands to the FICM.
- The PCM controls the fuel and air management systems on the 6.0L *Power Stroke*.



Glow Plug System

- The glow plug system is used to warm the air in the cylinders to enhance cold weather startability and reduce start up smoke.
- The glow plug system is PCM controlled.

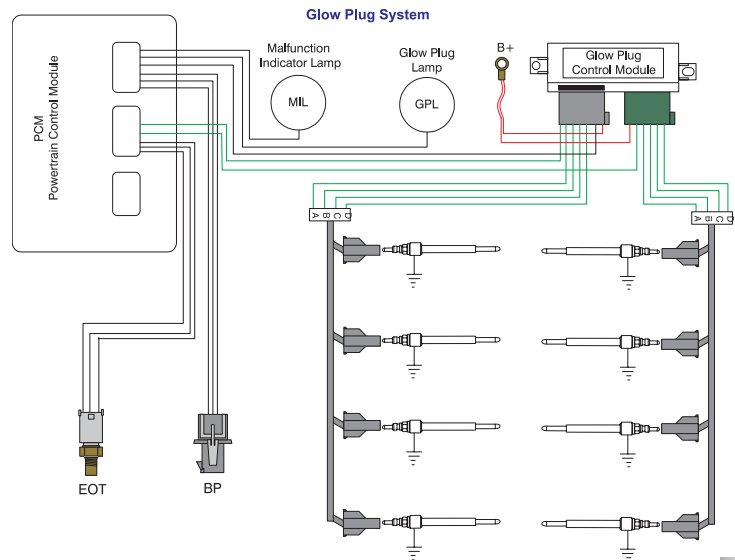

GPCM (Glow Plug Control Module)

- The GPCM (Glow Plug Control Module) is a unit that controls the glow plugs in order to warm the air in the cylinders.
- The GPCM uses a glow plug enable signal to turn the glow plugs on for a time controlled by the PCM.
- The GPCM is capable of diagnosing a problem with one glow plug and then sending a diagnostic signal to the PCM.
- It also has the ability to turn off one glow plug if a short is detected in that circuit.

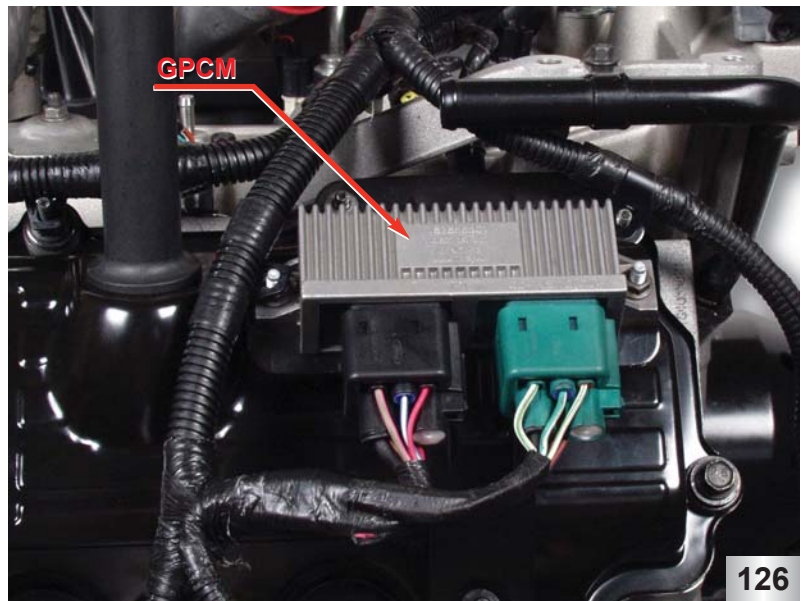

ELECTRICAL COMPONENTS



127

Glow Plug

- The glow plug is used to heat the air in the cylinder.
- Inside the plug are two (2) coils (resistance) connected in series, one to create heat and one to control heat at its peak.



128

Glow Plug Sleeve

- The glow plug sleeve is used to protect the glow plug from engine coolant and is made of stainless steel.



129

Glow Plug Buss Bar

- Each bank of glow plugs is connected to the wiring harness via a glow plug buss bar.
- The glow plug buss bar has four connectors attached to a single metal rail.
- The entire rail must be removed to gain access to any of the glow plugs on that bank.

ELECTRICAL COMPONENTS

Glow Plug System Diagnostics

- One way to verify diagnostic data from the GPCM is to measure the amperage draw with an inductive amp probe.
- Once the glow plug system has been commanded on by the PCM (when engine temperature is warm you may need to trick the system into a cold condition) for about 40 sec., the glow plug amperage should be stable. Each glow plug should draw between 10-12 amps.
- When testing the glow plug system, it is best to measure one bank of glow plugs at a time. The bank with the lower current draw would be the bank with the bad glow plug and/or wiring concerns.

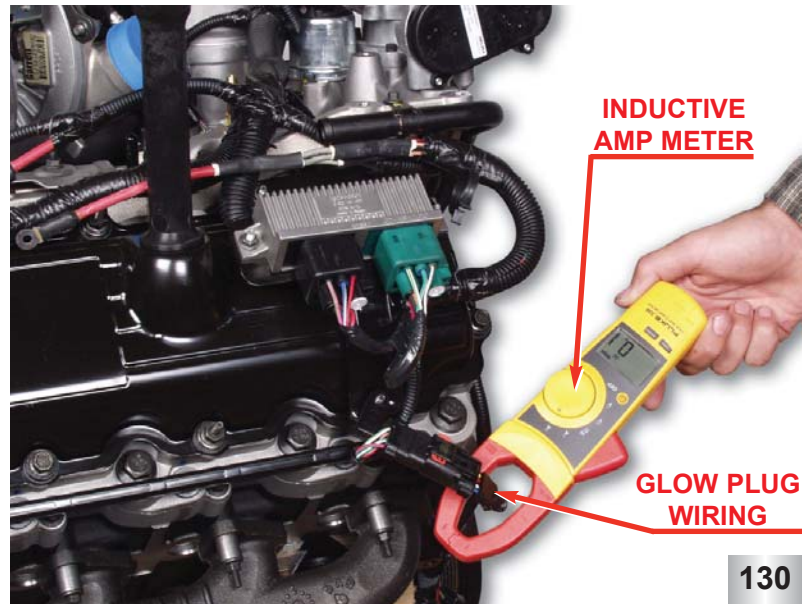

UNIQUE SERVICE PROCEDURES

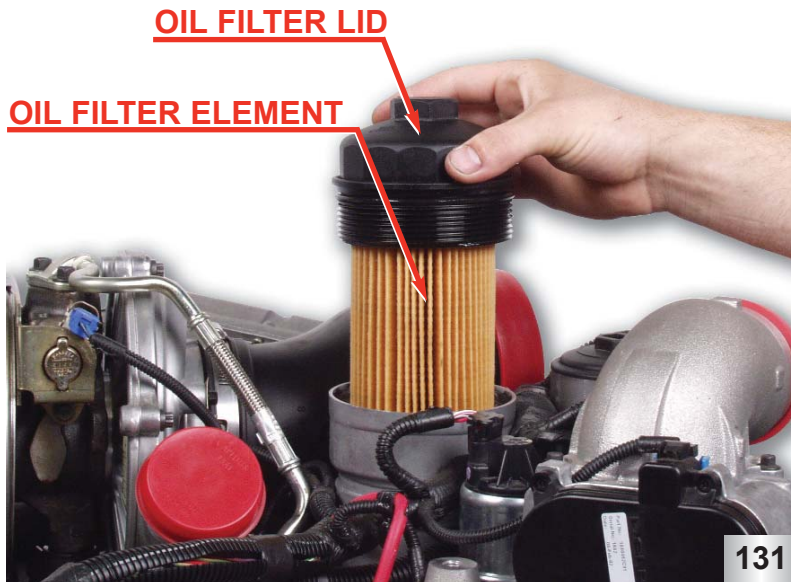

Oil Filter: Replacement

- First loosen the oil filter cap which will open the oil filter drain and allow the oil from the filter housing to drain into the crankcase.
- Drain the oil from the oil pan.
- After all of the oil has drained from the oil pan remove the oil filter and discard it in the appropriate location.
- **Note: The oil filter snaps into the oil filter lid.**
- Install the new oil filter element and tighten the oil filter cap to the recommended torque. This will close the oil filter drain.
- Refill crankcase with correct volume of recommended oil.

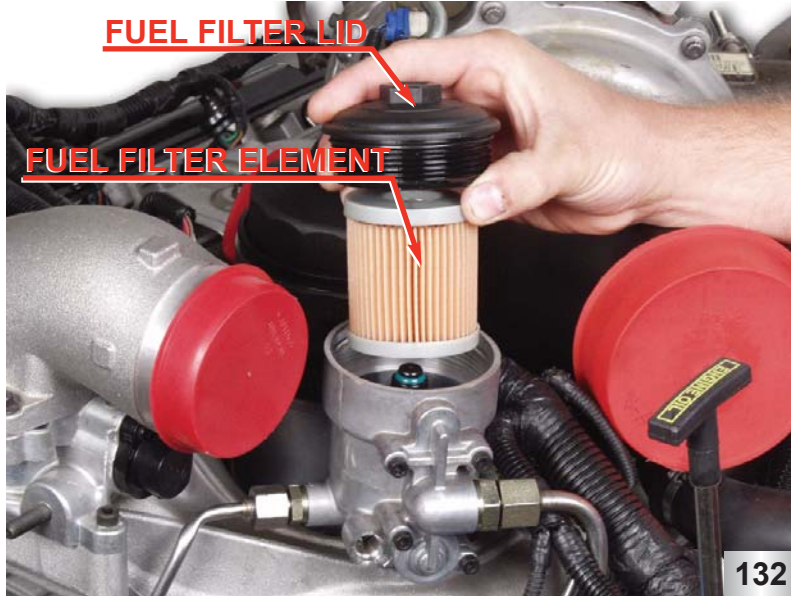

Fuel Filter: Replacement

- Remove the fuel filter lid and lift the filter element out of the housing and discard in the appropriate location.
- To avoid fuel spills, use a suction gun or similar device to remove the remaining fuel from the fuel filter housing.
- Install the new filter and tighten the fuel filter lid to the specified torque.
- **Note: Before starting the vehicle, cycle the key to the on position and let the fuel pump run a full cycle 3 times to ensure the fuel filter housing is full of fuel before starting the vehicle.**



Injector: Removal

- After removing the valve cover(s), disconnect the snap to connect fitting for the high pressure oil line leading to the high pressure oil rail using tool #303-755.
- Remove the eight (8) high pressure oil rail bolts that mount the oil rail to the rocker arm carrier.
- Pull the oil rail straight up to remove it.
- **Note: Do not pry against the valve cover sealing surface to remove the rail.**
- **Note: Oil will come out of the rail when the rail is removed.**

UNIQUE SERVICE PROCEDURES

Injector Removal: cont.

- The injector connectors on the 6.0L *Power Stroke* are locked into the rocker arm carrier.
- To disconnect the external engine wiring harness from the injector push in on the spring loaded metal clip on the harness.
- To remove the injector connector from the rocker arm carrier use a twelve (12) point 19mm socket. Place the open end of the socket over the connector and push inward lightly to disengage the locks and then pull the connector out of the rocker carrier.

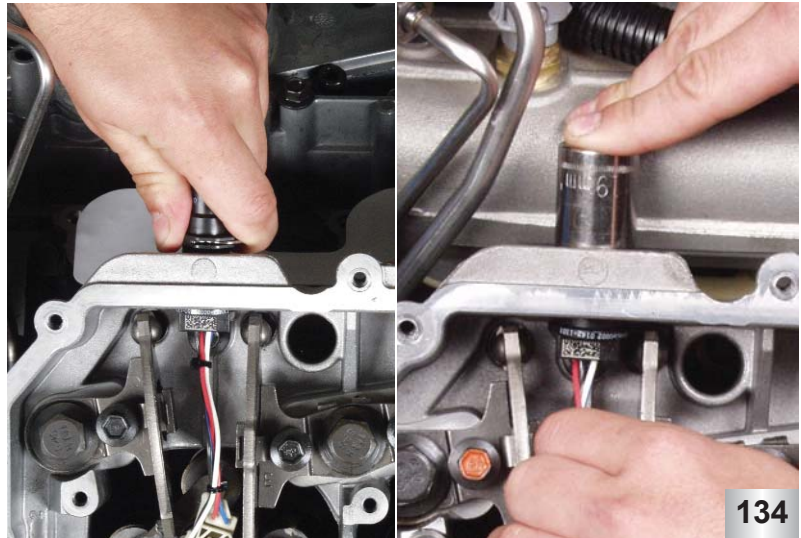

Injector Removal: cont.

- To remove the injector loosen the T40 torx socketed bolt that holds the injector in place this will also unseat the injector from it's bore.
- **Note: Do not use air tools to remove the injector.**
- Carefully lift the injector from the bore.
- **Note: Do not pry on the injector coils to remove the injector they may be damaged and are not replaceable. Also watch for rocker arm to injector interference.**
- **Note: Make sure that the copper gasket at the bottom of the injector has not fallen into the injector bore.**

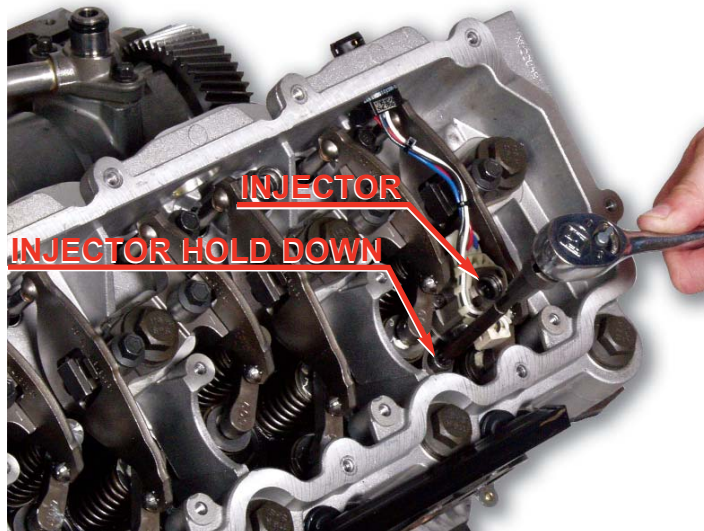

Injector O-ring: Replacement

- Once the injector has been removed, carefully remove the external o-rings.
- **Note: Be careful not to scratch the injector body during removal or the replacement o-rings may not seal.**
- Carefully install new o-rings on the injector body.
- **Note: If the o-ring is cut or nicked during assembly it will have to be replaced.**
- **Note: Do not pull on the wires while working with the injector.**

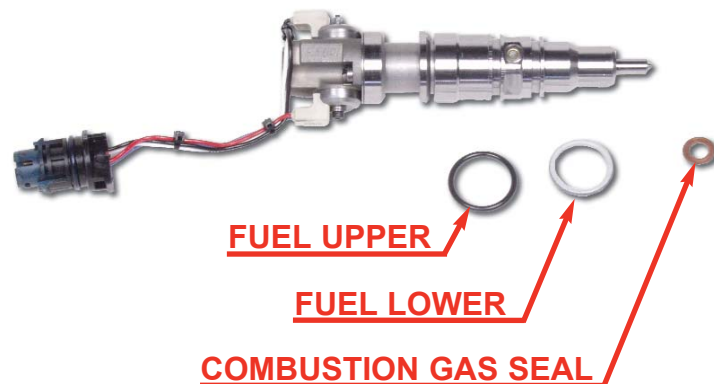

UNIQUE SERVICE PROCEDURES



137



138

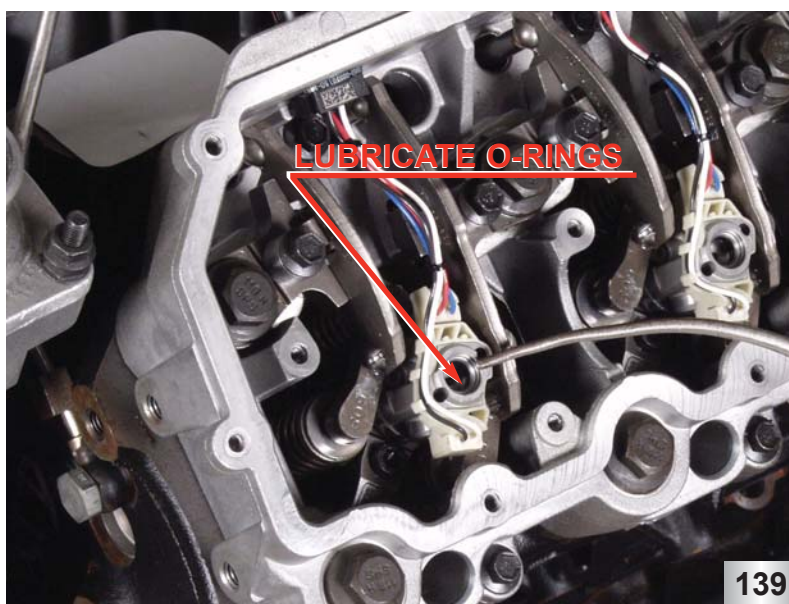

139

Injector O-ring Replacement: cont.

- To install the copper gasket to the injector tip use a twelve (12) point 9mm deep well socket so that pressure is applied evenly around the gasket during installation.
- **Note: If the gasket is mis-shaped or damaged during installation it must be replaced.**
- The internal upper o-ring is not removable. If the internal o-ring is leaking the entire injector assembly must be replaced.

Injector Installation

- Before installing the injector, the o-rings should be lubricated with clean engine oil.
- Place the injector into the bore with the injector hold down on the injector.
- **Note: Make sure that the copper washer does not fall off the tip of the injector during installation, engine damage could result if the gasket is not in place.**
- Using the hold down bolt to seat the injector in the bore, slowly tighten the bolt to the specified torque.
- **Note: Again do not use air/electric tools to install injectors.**

Injector Installation: cont.

- Before installing the high pressure oil rail to the rocker carrier, lubricate the internal o-ring that the oil rail jumper tube contacts.
- Place the oil rail over the injectors and seat it by hand. The oil rail should then be tightened as specified.
- **Note: Anytime injectors are changed Ford lubricity additive should be added to the fuel filter and fuel tank.**

UNIQUE SERVICE PROCEDURES

Cylinder Head - Rocker Carrier: Removal

- Before removing the rocker arm carrier the glow plug and injector connectors must be removed from the carrier.
- The rocker arm carrier is held in place with the cylinder head bolts.
- There are also five (5) small bolts that hold the cylinder head in place.
- **Note: If one or more of the cylinder head bolts are removed (required for rocker arm carrier replacement) then the cylinder head gasket and all cylinder head bolts must be replaced.**
- When reinstalling the carrier be sure to realign the rocker fulcrums as shown below.

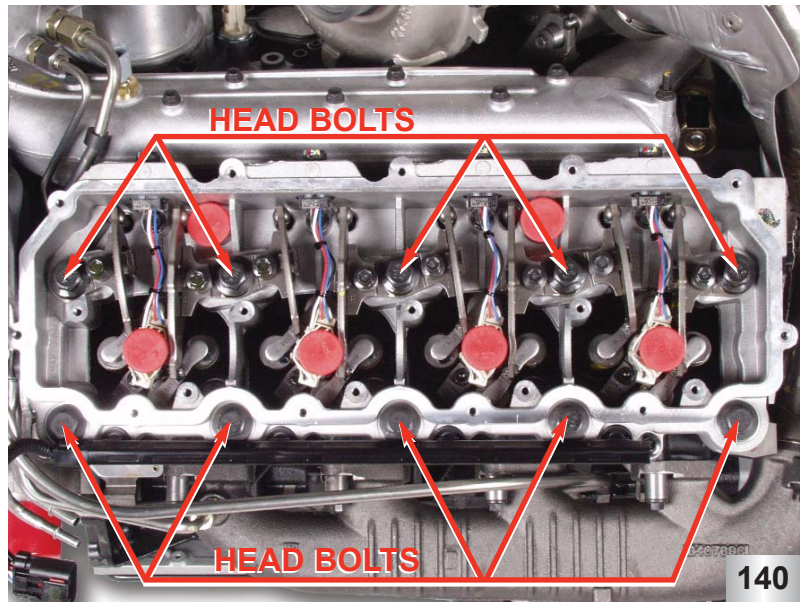

Rocker Arms / Bridges

- The rocker arms must be installed in their original position during reassembly.
- The valve bridges that connect the two (2) mating valves must be installed in their original position and orientation during reassembly.
- **Note: If the rocker arms and/or valve bridges are not correctly installed, premature valve train wear may result.**

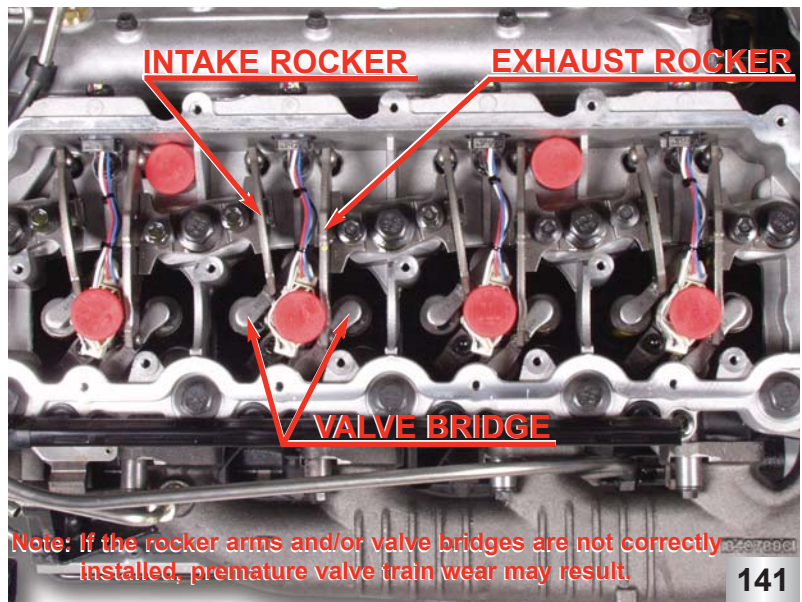

Cylinder Head - Rocker Fulcrums

- To remove the rocker arm fulcrums first remove the corresponding head bolt and then the small fulcrum retaining bolt.
- **Note: If one or more of the cylinder head bolts are removed (required for rocker arm carrier replacement) then the cylinder head gasket and all cylinder head bolts must be replaced.**
- When reinstalling the fulcrums make sure the alignment dowel is in place and not damaged to insure that the fulcrum is properly aligned for correct valve train geometry.
- First install the small fulcrum bolt, then the head bolt and torque to specifications.

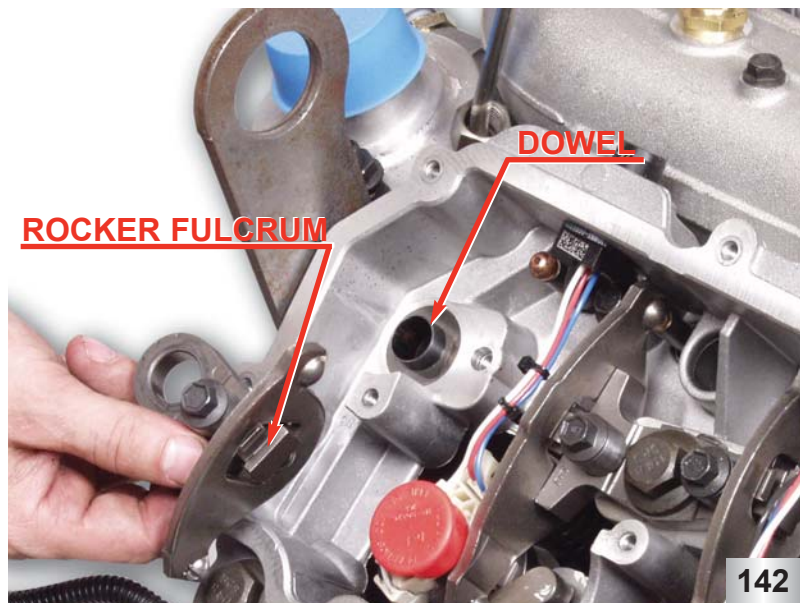

UNIQUE SERVICE PROCEDURES

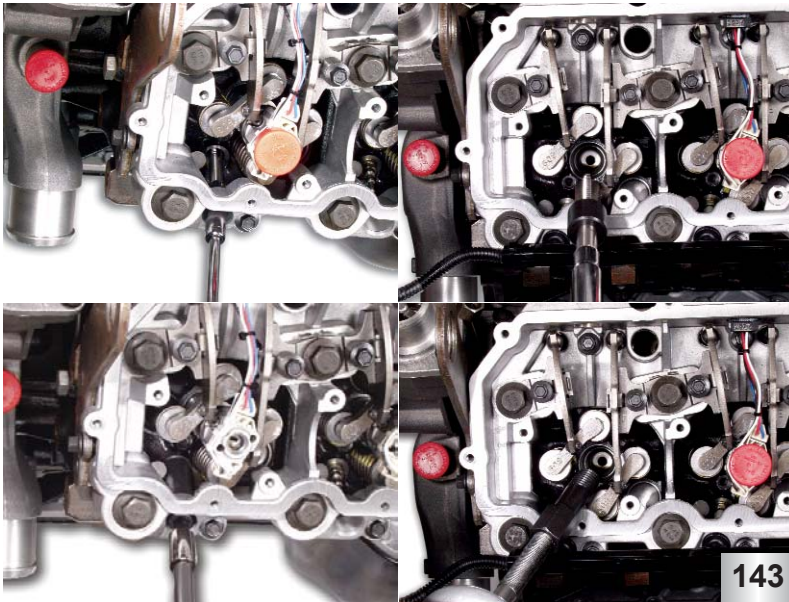

Glow Plug / Injector Sleeve: Removal

- Place the tap (part of tool #303-764) into the glow plug sleeve and cut threads into the sleeve.
- Remove the tap and insert the puller (part of tool #303-764) into the glow plug sleeve.
- Turn the puller clockwise until the sleeve is removed.
- Injector sleeve removal is similar to glow plug sleeve removal except that tool #303-768 is used.

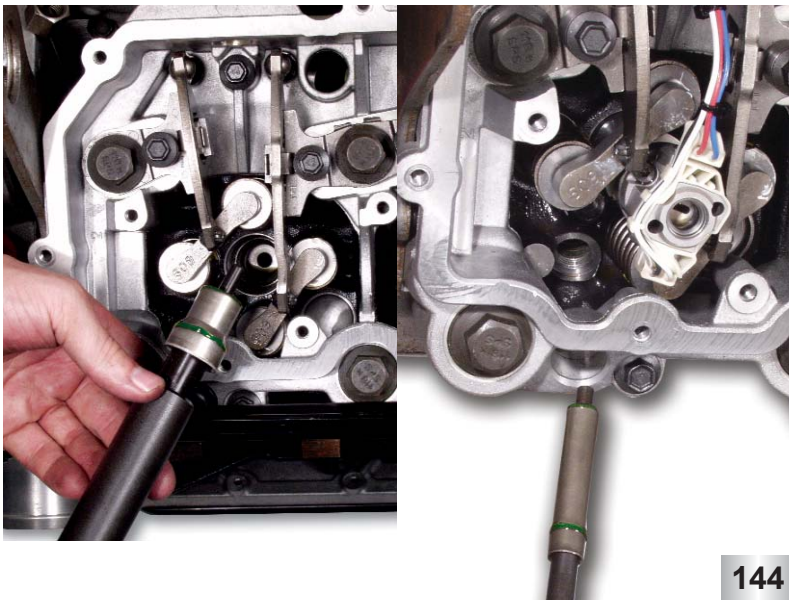

Glow Plug / Injector Sleeve: Installation

- Instructions for injector and glow plug sleeves are similar so the instructions are combined.
- First clean out any sealant from the bore before installing a new sleeve.
- Apply sealant (Loctite #620 green in color) to the two (2) locations that the sleeve contacts the cylinder head.
- **Note: Refer to service manual for proper location of sealant application.**
- Use the special tool (tool #303-767 for injector sleeve or tool #303-763 for glow plug sleeve) to drive the sleeve into its bore.



EGR Valve: Removal

- To remove the EGR valve, remove the two mounting screws from the intake manifold.
- Rotate the valve so that the mounting tabs on the valve align with the EGR valve puller (tool #303-760).
- Position the other two (2) legs of the puller on the bolt bosses of the intake manifold and turn the forcing screw clockwise.
- When reinstalling the valve check the o-rings for cuts and nicks.

UNIQUE SERVICE PROCEDURES

EGR Cooler: Removal & Installation

- Before removing the EGR cooler you must first drain the coolant from the cooling system.
- To disconnect the hose that supplies coolant to the EGR cooler, rotate it and pull till the tabs release.
- Both the inlet and outlet for exhaust gasses are sealed with metal gaskets.
- The coolant connections are sealed with o-rings.

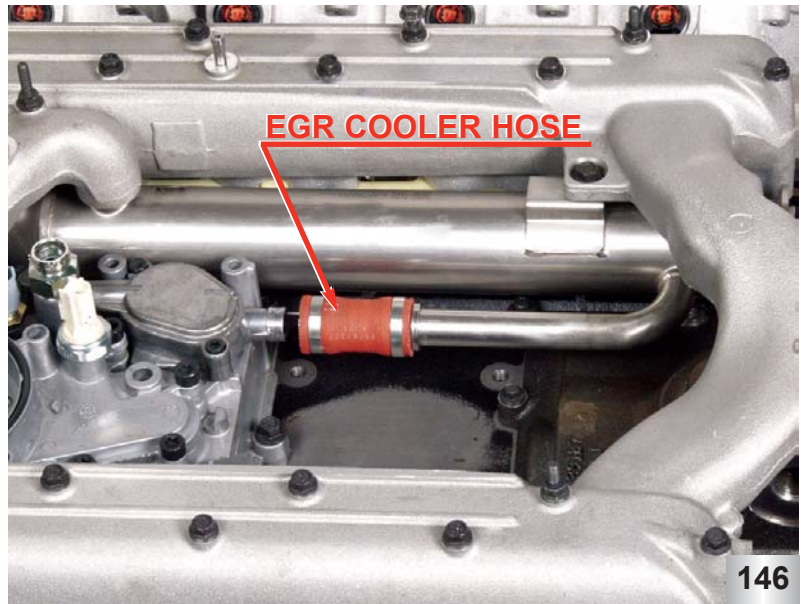

Turbocharger Oil Supply: Removal

- Use tool #303-755 to remove the oil feed to the turbocharger that is connected to the oil filter base.
- The connection at the turbocharger is a bolted flange and is sealed with a gasket.

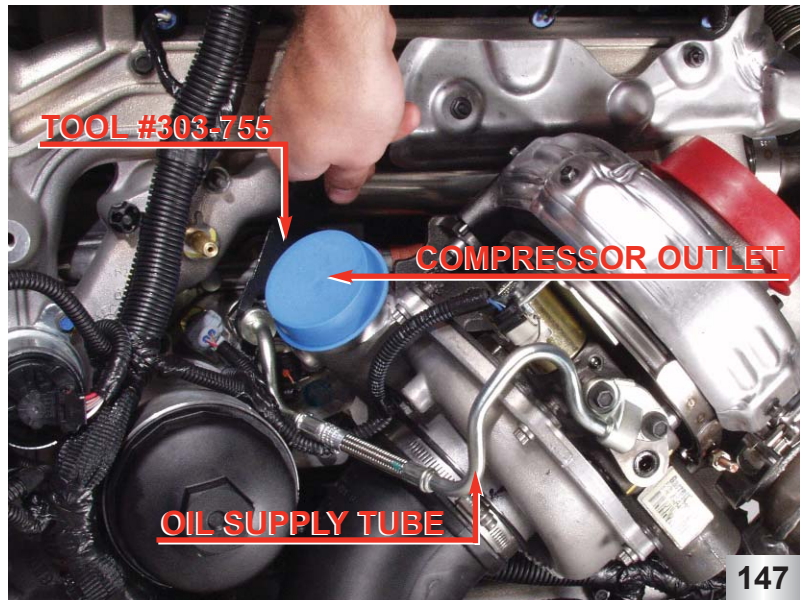

Crankcase Ventilation: Removal / Oil Carryover

- To disconnect the crankcase ventilation tube from the engine, remove the air inlet tube from the compressor inlet and rotate the vent counter clockwise until it releases.
- **Note:** Since the 6.0L POWER STROKE uses a closed crankcase ventilation system, it is normal to see oil carry over in the intake air system.

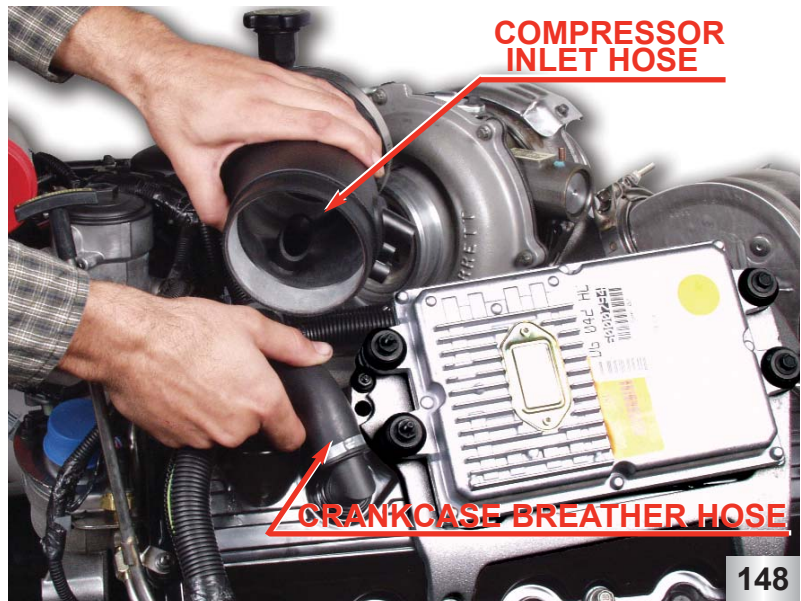

UNIQUE SERVICE PROCEDURES

**TURBO MOUNTING
PEDESTAL**

**TURBO OIL DRAIN
TUBE**

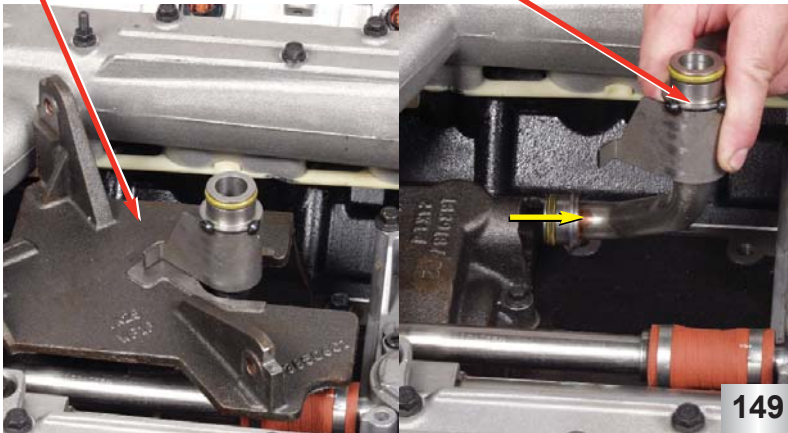

Turbocharger Oil Drain Tube: Removal

- The turbocharger oil drain is located under the turbocharger and is sealed with o-rings.
- To remove the drain tube pull it forward, out of the high pressure pump cover.

INTAKE PORTS

GASKET LOCATING TAB

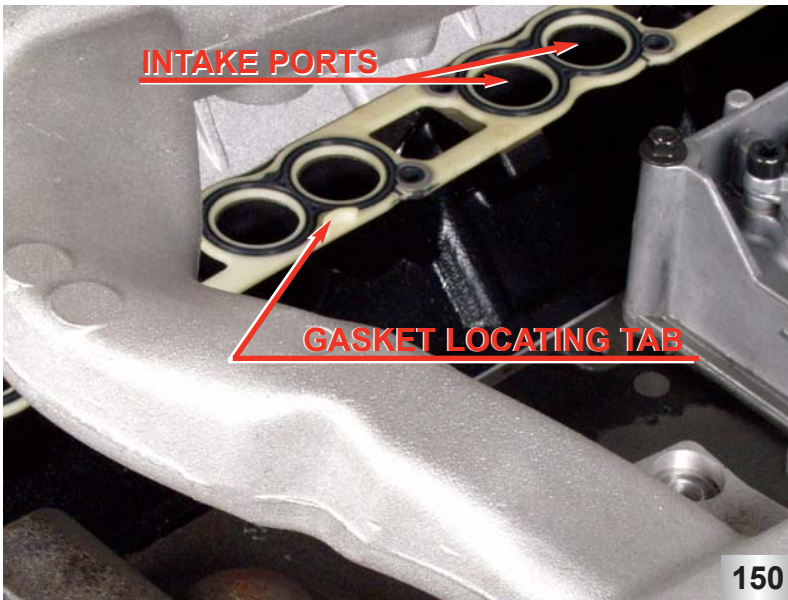

Intake Manifold

- When reinstalling the intake manifold, the locating tabs on the intake manifold gasket should face up and toward the center of the engine.
- There is a port on the intake manifold for cooling system deaeration that returns to the coolant reservoir.

TOOL #303 769

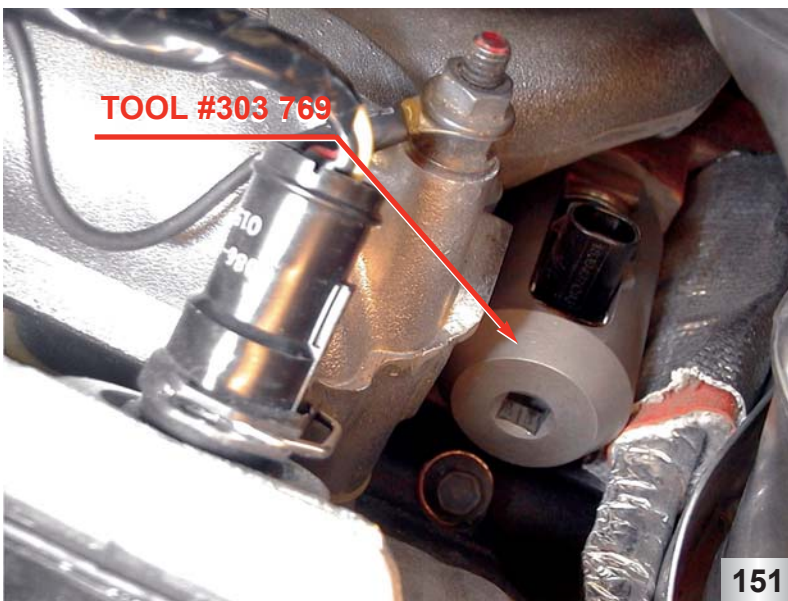

IPR Valve: Removal

- To remove the IPR valve use the IPR socket tool #303-769 and turn counterclockwise.
- **Note:** The connector for the IPR might hit the cylinder head. If this occurs the coil body can be repositioned on the valve.

UNIQUE SERVICE PROCEDURES

High Pressure Pump Cover: Removal

- After removing the bolts that hold the high pressure pump cover to the crankcase, pull the cover straight up to disengage it from the high pressure pump discharge tube.
- When reinstalling the cover, be sure to lubricate the discharge tube o-ring before installing the cover.

HIGH PRESSURE PUMP COVER

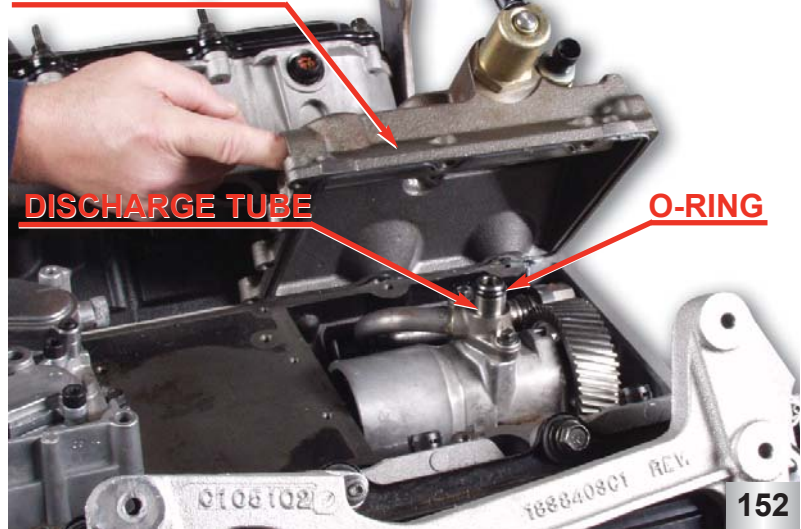

Front Cover: Removal

- The point where the crankcase and main bearing carrier meet, is sealed to the front cover gasket with a dab of RTV sealant that must be cut to remove the front cover gasket.

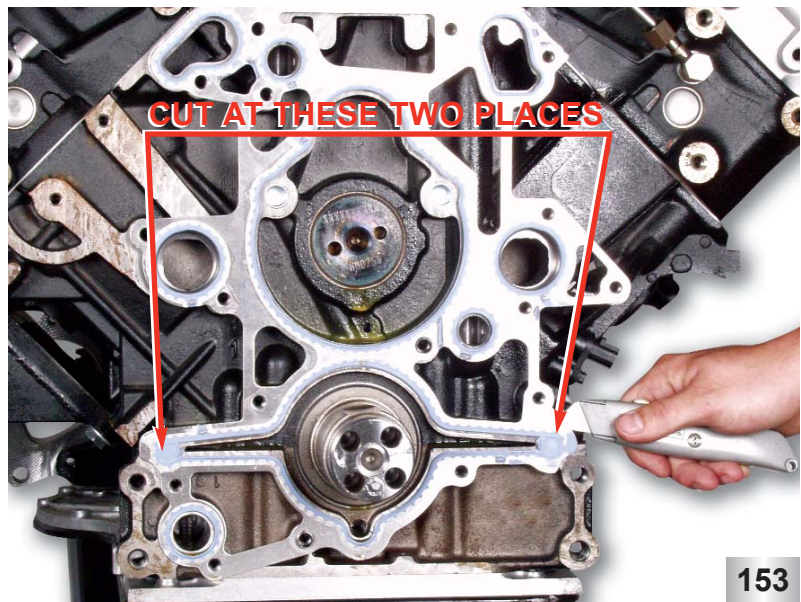

Front Cover: Dowel Locations

- The front cover is located to the crankcase with dowels.
- **Note:** If the dowels are missing or damaged the front cover could be misaligned and damage to the cover or oil pump could result.

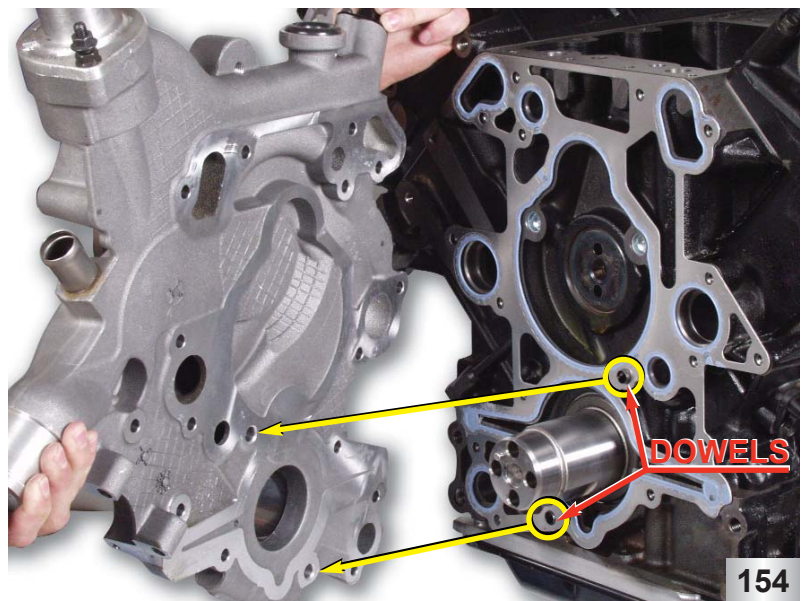

UNIQUE SERVICE PROCEDURES

Front Cover: Gerotor Oil Pump

- The lube oil pump is located to the front cover by dowels and sealed with a push in place gasket.

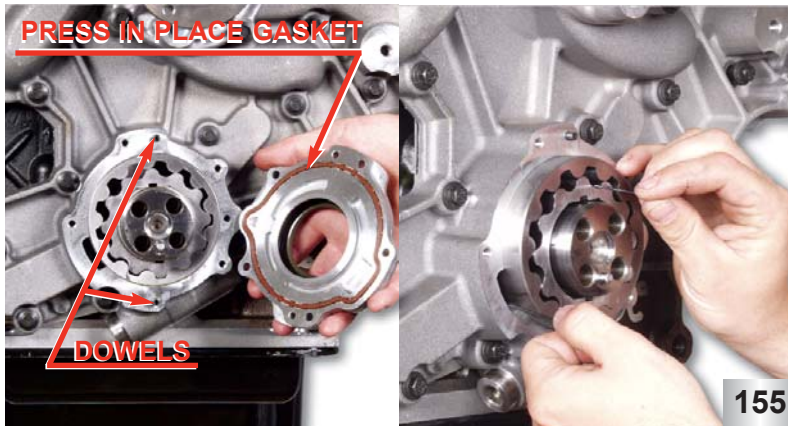

Front Cover: Sealant Application

- When installing the front cover the joint between the crankcase and main bearing carrier needs a dab of RTV sealer applied.
- **Note:** If too much sealant is applied it could get into the lube oil system.

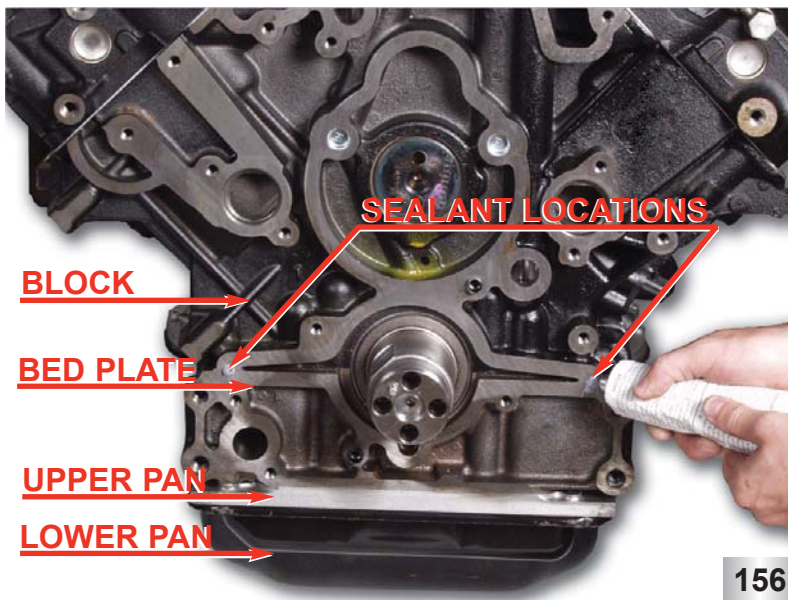

Glow Plug / Buss Bar: Removal

- In order to access the glow plugs, the glow plug buss bar must be removed.
- To remove the glow plug buss bar pull out on the bar evenly.
- After the buss bar has been removed, the glow plugs can be accessed through the rocker carrier.
- To reinstall the buss bar push evenly on the bar to seat the o-rings on each connection.
- **Note:** Do not hit the buss bar with a hammer, damage may occur.

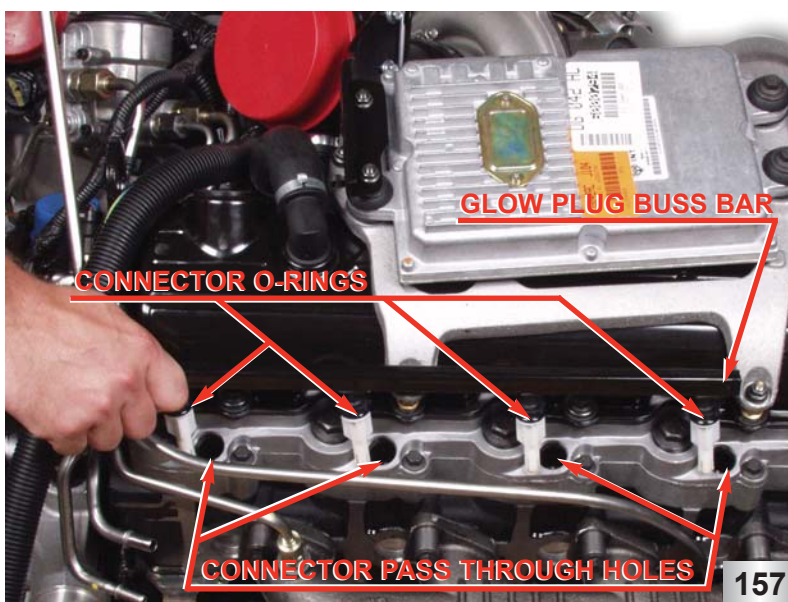

UNIQUE SERVICE PROCEDURES

Crankshaft Rear Seal Dust Cover

- There is a metal plate pressed onto the primary flange of the crankshaft.
- This plate acts as a dust shield for the rear seal and the mounting surface for the flexplate/flywheel.
- The plate must be removed before the rear cover can be removed.
- It can be removed with a common “finger type” gear puller.

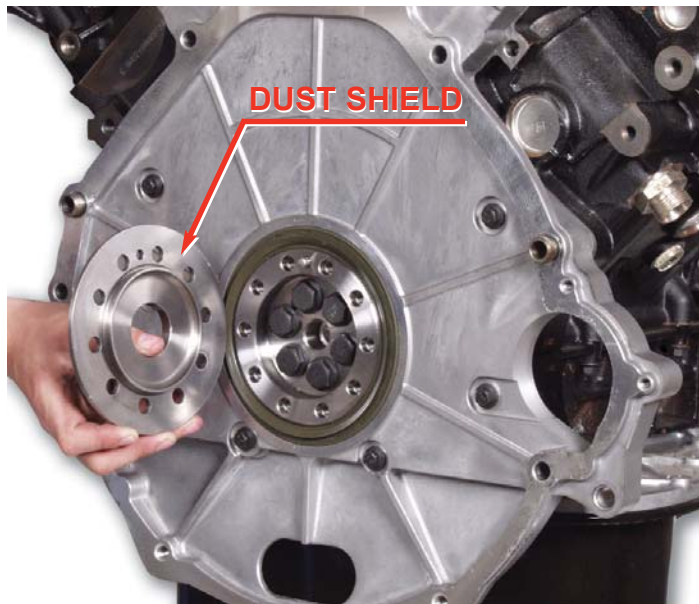

158

Crankshaft Primary Flange

- The crankshaft primary flange is bolted to the rear of the crankshaft and it provides the sealing surface for the rear seal.
- The flange is machined after being bolted to the crankshaft.
- **Note:** Do not remove the six bolts in the primary flange. If the bolts are removed the crankshaft will have to be replaced or repeated seal damage will occur.

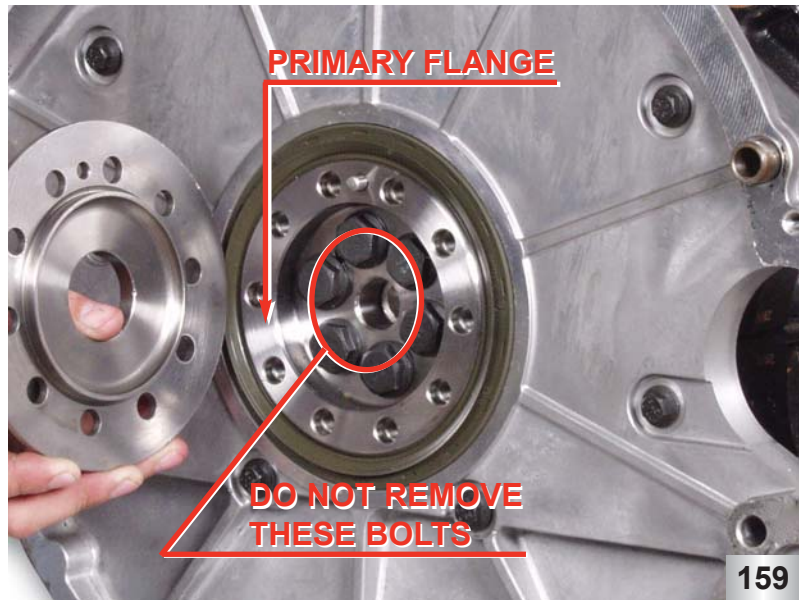

159



160

Air in Fuel

- Air in the fuel supply system can cause rough run, white smoke and low power.
- To check for air in the fuel system, remove the return line (to tank from fuel pump module) from the fuel pump module.
- Install a 1/4" ID hose to the fuel pump module and place the other end of the hose into a diesel fuel safe container.
- Turn the ignition to the on position. The fuel pump will run for approx. 20 sec.. Continue to cycle the key to the on position until fuel flows from the attached hose.
- Start the engine, run at WOT, and observe the returning fuel for air.
- If air is present, the fuel will appear white, foamy, or non-transparent. If no or very little air is present in the fuel, the fuel exiting the return hose will appear clear/transparent.
- Were to look?
 - a) Fuel pick up in the fuel tank.
 - b) Fuel supply line entering the fuel pump module from the fuel tank.
 - c) Fuel return line entering the fuel pump module from the engine.
 - d) Combustion leaks past the copper washer on the injector.



161

High Boost/High EP at WOT no Load

- If high boost (consistently over 14 psi MGP) and high exhaust pressure (consistently over 23 psi EP) is present at WOT no load, the VGT or VGT control valve may be at fault.
- To verify that the VGT is not being commanded to a closed position, disconnect the wiring at the VGT control valve and run the engine at WOT.
- If the readings do not return to normal then the VGT or VGT control valve are at fault.

GENERAL DIAGNOSTICS

ICP Pressure Low During Crank

- If you have no (0 psi) ICP pressure during crank it could be the result of: major high pressure oil leak, lack of oil supply to the high pressure pump, bad high pressure pump, or the gear on the high pressure pump is loose. Use PC/ED ICP diagnostics to determine root cause.
- If ICP during crank is between 200-300 psi and does not change as IPR duty cycle increases, the IPR valve may not be receiving V-power or a ground signal from the PCM. If V-power and PCM signal are present then the IPR may be at fault. Use PC/ED IPR Diagnostics to determine root cause.



Power or Ground Issues

- When diagnosing a power or ground issue be aware that there is a 12 way connector that feeds power and/or ground to the following components.
- FICM
- IPR
- EGR
- The 12 way connector is located in the rear left hand corner of the engine compartment.

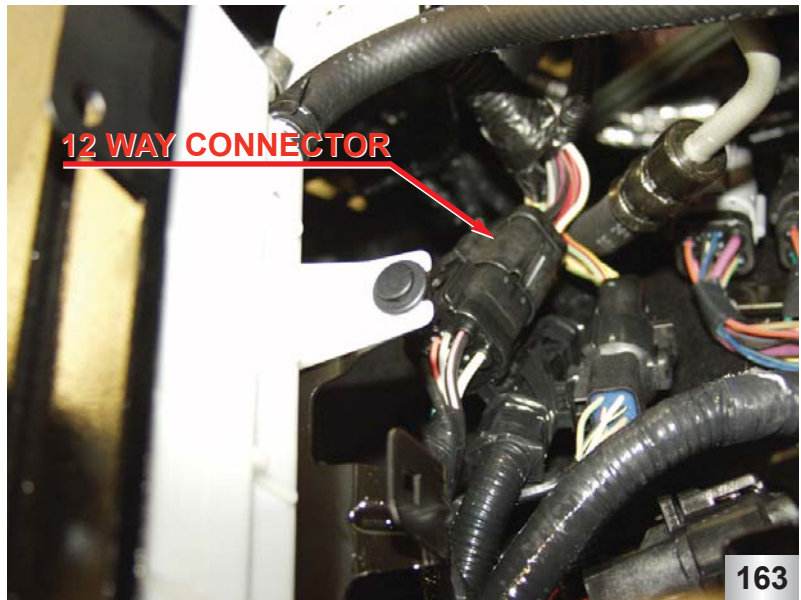

Injector I/O Test

- There is now a new test incorporated into the WDS.
- This test allows the technician to disable one injector at a time and monitor pids to identify weak injectors.
- While disabling injectors watch the Mfdes pid. The injector(s) that have the least effect on Mfdes while being disabled could be the weak injector.

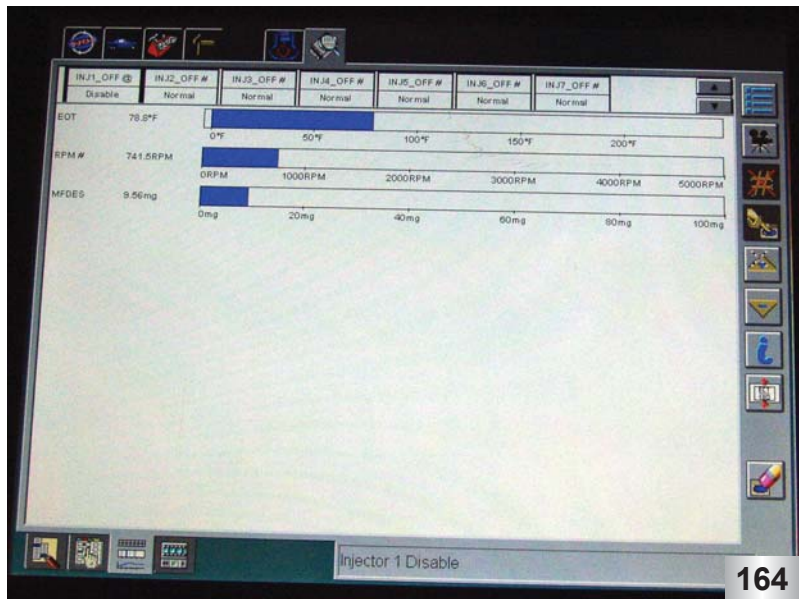

GENERAL DIAGNOSTICS

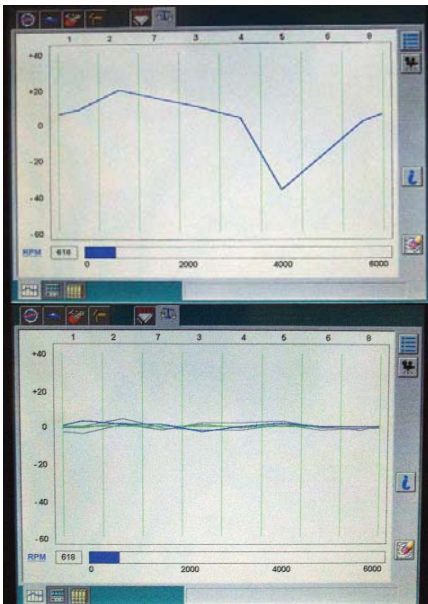

#5 INJECTOR OFF

ALL INJECTORS ON

165

Cylinder Balance Test

- The cylinder balance test is now available for the 6.0L *Power Stroke*.
- The cylinder balance test measures the increase of engine RPM during each firing cycle. It then compares the RPM of all cylinders to determine a weak cylinder.
- Further testing should be done to verify the weak cylinder (Relative compression, Injector disable, actual compression, etc.).



#5 GLOW PLUG REMOVED

GOOD ENGINE

166

Relative Compression Test

- The relative compression test is now available for the 6.0L *Power Stroke*.
- The relative compression test measures engine RPM during each compression stroke while cranking the engine. It then compares the RPM of all of the cylinders to determine if there is a cylinder that is weaker than the rest.
- Once a cylinder is determined to be weak a manual compression test should be run on that cylinder and a good cylinder to verify results.



NON AERATED OIL

AERATED OIL

167

Oil Aeration Test

- If oil aeration is suspected, install a valve and hose into the oil system at either the EOT or EOP sensor.
- **Note: All materials being used should be rated above 300 psi and 300°F.**
- Run the engine until the oil is at a normal operating temperature.
- Run the engine at high idle for approximately one minute and then return to idle.
- With engine at idle open the valve and drain a sample of oil into a clear container and observe for air or foam in the oil.
- **Caution: Oil will be hot and under pressure.**

GENERAL DIAGNOSTICS

Crankcase Pressure Test

- A new crankcase pressure orifice tool has been developed for the 6.0L *Power Stroke*.
- The new tool has a smaller orifice in the top so that more accurate readings could be taken with the 0-60" gauge on the gauge bar.
- When using the new tool on the 6.0L *Power Stroke* the maximum reading for a good engine is 8" of water.



Injector Buzz/No Buzz

- Every time the key is cycled to the on position, the injectors should buzz.
- If no buzz is heard one of the following conditions may be present:
 - a) No power or ground to the FICM or PCM.
 - b) No CAN communication between the FICM and the PCM.
 - c) V-ref shorted to ground.
 - d) Bad PCM or FICM.
 - e) All injectors bad or wiring to all injectors bad (not likely).
- If the injectors do buzz and all conditions are met for the engine to run but the injectors do not fire during crank, check the FICM logic power feed to the FICM.
- To check powers and grounds to the FICM you can bring up the following pids on the WDS:
 - FICMVPWR (FICM Vehicle Power battery voltage)
 - FICMMPWR (FICM Main Power or output voltage approximately 48 volts)
 - FICMLPWR (FICM Logic Power battery voltage)

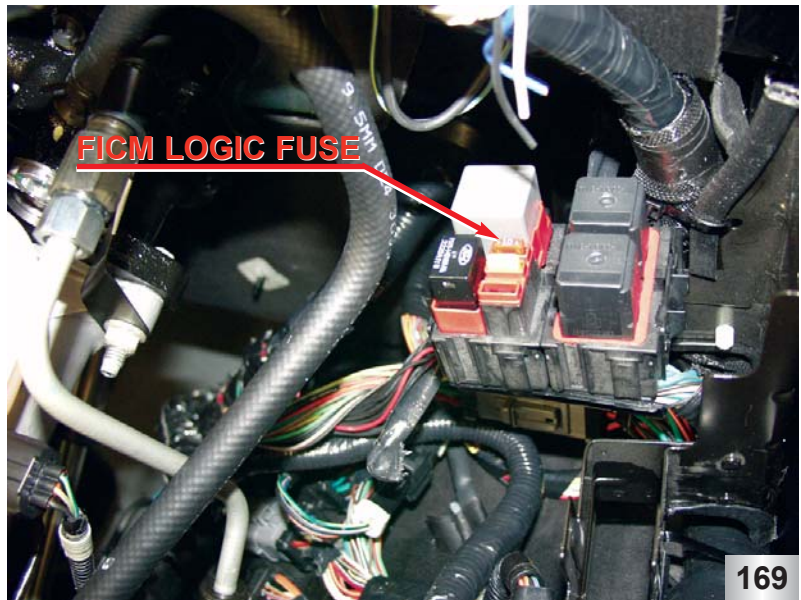

TABLE OF CONTENTS

Torque Charts84
Hard Start/No Start Diagnostics88
Performance Diagnostics89
Wiring Diagrams90
Diagnostic Codes94
Glossary97
Index100
Notes103

SPECIAL TORQUE CHART

COMPONENT	STANDARD	METRIC
Lower crankcase outer bolts	18 lbf/in	24 Nm
Oil cooler mounting bolts (M8)	16 lbf/ft	22 Nm
(M6)	89 lbf/in	10 Nm
Oil filter cap	18 lbf/ft	24 Nm
Oil filter housing bolts	11 lbf/ft	15 Nm
Oil filter stand pipe bolt (new)	53 lbf/in	6 Nm
(reinstallation)	27 lbf/in	3 Nm
Oil pan drain plug (see note 3)	18 lbf/ft	25 Nm
Oil pickup tube flange bolts	18 lbf/ft	24 Nm
Oil pump housing bolts	72 lbf/in	8 Nm
Oil pressure regulator plug	19-21 lbf/ft	26-29 Nm
Piston cooling jet (see note 4)	10 lbf/ft	13 Nm
Rocker arm fulcrum bolts	23 lbf/ft	31 Nm
Water pump bolts (M8)	17 lbf/ft	23 Nm
Water pump plugs	26-28 lbf/ft	35-38 Nm
Water pump pulley bolts	23 lbf/ft	31 Nm
Thermostat housing bolts	17 lbf/ft	23 Nm
Turbo exhaust adapter v-band clamp	80 lbf/in	9 Nm
Turbo oil supply bolts	18 lbf/ft	24 Nm
Turbo oil supply snap to connect fitting	8-13 lbf/ft	11-18 Nm
Turbo to mounting bracket bolts (see note 2)	28 lbf/ft	38 Nm
Turbo bracket to crankcase mounting bolts	23 lbf/ft	31 Nm
Valve cover bolts	71 lbf/in	8 Nm
Vibration damper (see note 5) (initial)	50 lbf/ft	68 Nm
(Final)	additional 90 degrees rotation	

STANDARD TORQUE CHART

Hex Flange Head

Thread Diameter	Torque lbf/ft	Torque Nm	Wrench Size (mm)
M6 x 1	8	11	8
M8 x 1.25	18	24	10
M10 x 1.5	36	49	13
M12 x 1.75	61	83	15
M16 x 2	154	208	21

Hex Head

M6 x 1	6	8	10
M8 x 1.25	15	20	13
M10 x 1.5	30	40	16
M12 x 1.75	51	69	18
M16 x 2	128	173	24

Pipe Thread

1/8" NPT	7	10.2
1/4" NPT	10	13.6
3/8" NPT	15	20.4
1/2" NPT	25	34.0
3/4" NPT	30	40.8

Special Torque Chart Notes

- 1) Tighten 2 M6 studs in front EGR cooler flange first then install M8 EGR cooler support bolt.
- 2) Apply High Temperature Nickel Anti-Seize Lubricant (F6AZ-9L494-AA) to threads of bolts prior to assembly.
- 3) Lightly coat o-ring with engine oil before installing.
- 4) Apply Threadlock 262 to bolt threads prior to assembly
- 5) Tighten bolts across center of crankshaft.
Always use new bolts in vibration damper!

- All Figures on next page.

SPECIAL TORQUE CHART

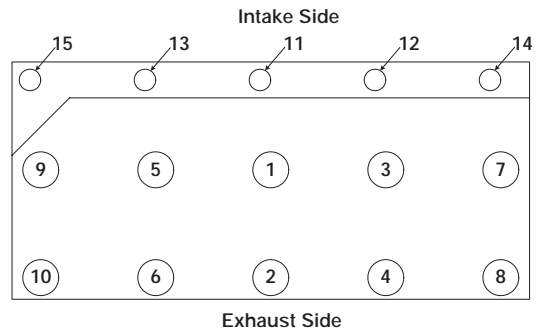

Figure A

Cylinder Head Bolts

- Step 1: Torque the M14 (1-10) cylinder head bolts to 65 lbf/ft (88 Nm) in the numerical sequence shown.
- Step 2: Torque the M14 cylinder head bolts 1, 3, 5, 7, & 9 to 85 lbf/ft (115 Nm) in the numerical sequence shown.
- Step 3: Tighten the M14 cylinder head bolts an additional 90° clockwise in the numerical sequence shown.
- Step 4: Tighten the M14 cylinder head bolts an additional 90° clockwise in the numerical sequence shown.
- Step 5: Tighten the M14 cylinder head bolts an additional 90° clockwise in the numerical sequence shown.
- Step 6: Torque the M8 (11-15) cylinder head bolts to 18 lbf/ft (24 Nm) in the numerical sequence shown.
- Final Step: Torque the M8 cylinder head bolts to 24 lbf/ft (32 Nm) in the numerical sequence shown.
- **Note: Always use new head bolts.**

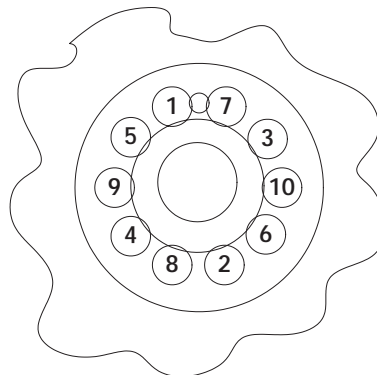

Figure B

Flywheel Bolts

- Step 1: Torque the bolts to 1-5 lbf/ft (1.4-7 Nm) in the numerical sequence shown above.
- Final step: Torque the bolts to 69 lbf/ft (94 Nm) in the numerical sequence shown above.

SPECIAL TORQUE CHART

High Pressure Oil Rail Bolts

- Step 1: Install bolts 1, 2 and 3 finger tight.
- Step 2: Press rail down until seated.
- Final step: Install remaining bolts and torque to 96 lbf/in (11 Nm) in sequence shown above.

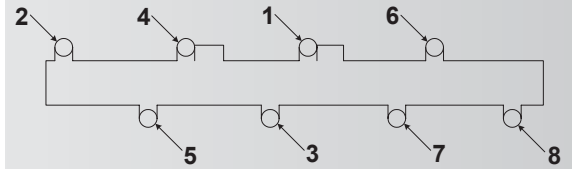

Figure C

Intake Manifold Bolts

- Step 1: Install bolts 1 through 8 finger tight.
- Step 2: Torque bolts 9 through 16 to 8 lbf/ft (11 Nm).
- Final step: Torque all bolts to 8 lbf/ft (11 Nm) in the numerical sequence shown.

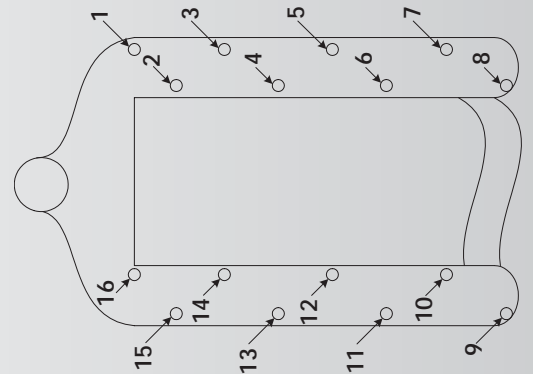

Figure D

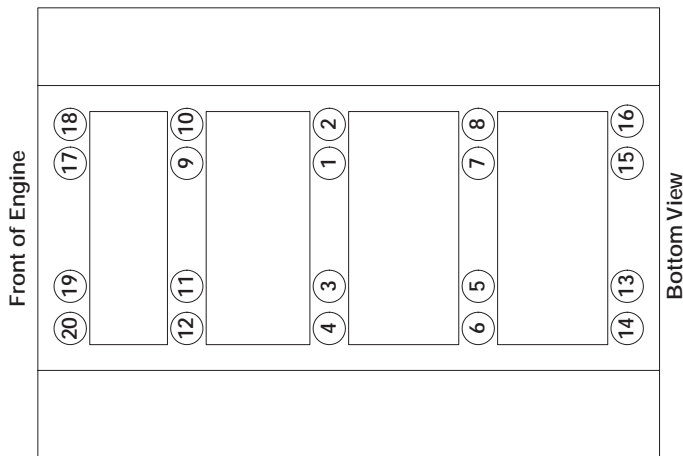

Figure E

Main Bearing Bolts

- Step 1: Torque the bolts to 110 lbf/ft (149 Nm) in the numerical sequence shown.
- Step 2: Torque the bolts to 130 lbf/ft (176 Nm) in the numerical sequence shown.
- Final step: Torque the bolts to 170 lbf/ft (231 Nm) in the numerical sequence shown.

HARD START/NO START DIAGNOSTICS

<p>F-Series/Excursion Powerstroke 2003.25 6.0L Power Stroke Diesel Engine Diagnostic Guide</p>	<p>-NOTE- IF CONCERN IS FOUND, SERVICE AS REQUIRED. IF THIS CORRECTS THE CONDITION, IT IS NOT NECESSARY TO COMPLETE THE REMAINDER OF THE DIAGNOSTIC PROCEDURE.</p>	<p>CUSTOMER NAME _____</p> <table border="1" style="width: 100%; border-collapse: collapse;"> <tr> <td style="width: 50%;">MODEL YEAR _____</td> <td style="width: 50%;">VEHICLE SERIAL NO.(VIN) _____</td> </tr> <tr> <td colspan="2">CHASSIS STYLE _____</td> </tr> </table>	MODEL YEAR _____	VEHICLE SERIAL NO.(VIN) _____	CHASSIS STYLE _____	
MODEL YEAR _____	VEHICLE SERIAL NO.(VIN) _____					
CHASSIS STYLE _____						
Customer Concerns (Please list in this box) _____						
DEALER NAME _____	P & A CODE _____	1863 CLAIM NUMBER _____ DATE _____				
ENGINE SERIAL NUMBER _____	ODOMETER _____	TYPE OF SERVICE _____				
VEHICLE GVW _____	TRANSMISSION _____	AMBIENT TEMPERATURE _____				
		PERSONAL <input type="checkbox"/> COMMERCIAL <input type="checkbox"/>				

NOTE: A hard start/ No start concern with EOT Temp. below 60F perform step 10 first.

1. Visual Engine/Chassis Inspection

<i>Fuel Oil Coolant Electrical Hoses Leaks</i>	
Method	Check
Visual	

2. Check Engine Oil Level

- Check for contaminants (fuel, coolant).
- Correct Grade/Viscosity.
- Miles/Hours on oil ,correct level.

Method	Check
Visual	

3. Intake/Exhaust Restriction

- Inspect air filter and inlet ducts.
- Inspect exhaust system.
- Check if air filter minder indicator has been illuminated

Method	Check
Visual	

4. Sufficient Clean Fuel

- Check if the WATER IN FUEL lamp has been illuminated.
- After verifying that there is fuel in the tank, drain a sample from fuel control module.
- Cetane rating between 40-50 is recommended for optimum start.

Method	Check
Visual	

5. Electric Fuel Pump Pressure

- Verify that the fuel pump has voltage and gnd. At key on.
- Measure fuel pressure at engine fuel filter housing test port with a (0-160 PSI) gauge at key on.

Fuel pump runs for 20 sec. at key on and pressure falls after key off.

Instrument	Spec.	Measurement
0-160 PSI Gauge	45 PSI min.	

If pressure falls low go to next step to verify no restriction

6. Electric Fuel Pump Inlet Restriction

- Measure restriction at fuel pump inlet.

Instrument	Spec.	Measurement
0-30 " Hg vacuum	6" Hg MAX	

If > 6" Hg restriction, check lines between pump and fuel tank.
If < 6" Hg, inspect both fuel filters. If filters are OK, check fuel regulator. If regulator and filters are OK, replace fuel pump.

7. Perform KOEO On-Demand Self Test

- Use scan tool. DTC's set during this test are current faults

Diagnostic Trouble Codes	
--------------------------	--

8. Retrieve Continuous Trouble Codes

- Use the scan tool.
- DTC's retrieved during this test are historical faults.

Diagnostic Trouble Codes	
--------------------------	--

9. KOEO Injector Electrical Self Test (Click Test)

- Use scan tool. Injector DTC's will be displayed at test end.
- All injectors will momentarily click, then each injector will click in sequence 1-8. Sequence repeats three times.

Injector Trouble Codes	
------------------------	--

If self test codes are retrieved, go to appropriate PPT test.

10. Scan Tool - Data List Monitoring

- Scan tool may reset below 9.5 volts.
- Select the parameters indicated from the scan tool parameter list and monitor while cranking engine.

Parameter	Spec.	Measurement
V PWR	8 volt min.	
FICMLPWR		
FICMVPWR		
RPM	100 RPM minimum	
ICP	3.5 mPa min. (500 PSI)	
ICP volts	.80 V min.	
FUEL PW	500 uS - 2 mS	
FICMSYNC	Yes/No	

A - V PWR - If low voltage condition is present, check battery, charging system, or power/gnd circuits to the PCM.

B - FICMLPWR - No/low voltage indicated could be caused by 12-way connector issue or logic power fuse.
Refer to Pinpoint S for detailed 12-way conn. diagnostics

C - FICMVPWR - No or low voltage indicated could be caused by 12-way connector issues.

D - RPM - Low RPM can be caused by starting/charging system issues. No RPM indicated while cranking could be CMP or CKP faults.

E - ICP - A minimum of 500 PSI (3.5 mPa) is required for the injectors to be enabled. No or low oil in the system, system leakage, injector O-Rings, faulty IPR, or high pressure pump could cause low pressure.

IPR duty cycle defaults to 14 % (300 PSI) w/o CKP signal.

F - ICP V - Voltage reading below spec indicates low ICP during crank.

G - FUEL PW - Pulse width defaults to 0 w/o CKP signal

H - FICMSYNC - No sync could be caused CMP or CKP faults.

Refer to PC/ED section 4 for detailed test procedures.

11. Glow Plug System Operation

GPCM Operation

- Glow Plug ON time is dependent on oil temperature and altitude. The Glow Plug Control Module (GPCM) comes on between 1 and 120 sec., and does not come on at all if oil temp is above 131 F.
- Using a scan tool , check Continuous and KOEO DTC's. If codes are present go to Pinpoint Test AF.
- Verify B+ voltage is being supplied to GPCM.
- Using the scan tool GPCTM and EOT pids, verify glow plug "on" time .
- Turn key to run position, measure voltage ("on" time)

(Dependent on oil temperature and altitude)

Relay on time	Spec.	Measurement
1 to 120 seconds	B +	

Wait to Start Lamp "on" time is independent from g/p "on" time

Glow Plug Resistance

- Disconnect the 4-pin connector at front of valve cover
- Measure each Glow Plug resistance to Bat. ground.
- Measure engine harness resistance to GPCM

Glow Plug Number	Glow Plug to Ground .1 to 2 ohms	Harness to GPCM connector 0 to 1 ohms
#1		
#3		
#5		
#7		
#2		
#4		
#6		
#8		

Time (seconds) vs EOT (°F)

- Add 5 seconds to glow plug on time when above 7000 feet in altitude, but not to exceed 120 seconds.

See PC/ED manual, Section 4A for more detail on all of the above test steps

When troubleshooting a Hard Start/No Start or Performance concern, this form must be filled out to the point of repair and returned to receive warranty credit and diagnostic time for the following parts: Fuel Injectors (9E527), regulator-injection control pressure(9C968), pump assembly high pressure oil (9A543), turbo charger assembly/pedestal (6K684), fuel pump (9350), FICM (12B599) and PCM (EEC)(12A650)

Labor operations listed more than once are a continuation of the diagnostic procedure and should be claimed only once.

What problems were found and what repairs were performed?

List Part Name, Number and Serial Number of parts replaced.

PERFORMANCE DIAGNOSTICS

 F-Series/Excursion Powerstroke 2003.25 6.0L Power Stroke Diesel Engine Diagnostic Guide	-NOTE- IF CONCERN IS FOUND, SERVICE AS REQUIRED. IF THIS CORRECTS THE CONDITION, IT IS NOT NECESSARY TO COMPLETE THE REMAINDER OF THE DIAGNOSTIC PROCEDURE.	CUSTOMER NAME <hr/> MODEL YEAR VEHICLE SERIAL NO.(VIN) <hr/> CHASSIS STYLE
---	--	---

Customer Concerns (Please list in this box)

DEALER NAME	P & A CODE						1863 CLAIM NUMBER	DATE	
	ENGINE SERIAL NUMBER				ODOMETER			TYPE OF SERVICE	
VEHICLE GVW	TRANSMISSION		AMBIENT TEMPERATURE					PERSONAL <input type="checkbox"/>	COMMERCIAL <input type="checkbox"/>

1. Visual Engine/Chassis Inspection

- Verify that there are no fluid or pressure leaks.
- Inspect all wire connections for damage.
- Inspect MAP hose,intercooler hose,and manifolds for leaks.

<i>Fuel Oil Coolant Electrical Hoses Leaks</i>	
Method	Check
Visual	

2. Sufficient Clean Fuel

- Check if WATER IN FUEL indicator has been illuminated.
- Drain sample from fuel control module housing.
- Cetane rating between 40-50 is recommended for optimum performance

Method	Check
Visual	

3. Check Engine Oil Level

- Check for contaminants (fuel, coolant).
- Correct Grade/Viscosity.
- Miles/hours on oil, correct level.

Method	Check
Visual	

4. Perform KOEO On Demand Test

- Use the scan tool.
- DTCs set during this test are current faults.

Diagnostic Trouble Codes	
---------------------------------	--

5. Retrieve Continuous DTC's

- Use the scan tool.
- DTCs retrieved during this test are historical faults.

Diagnostic Trouble Codes	
---------------------------------	--

6. KOEO Injector Electrical Self-Test

- Use the scan tool.
- All injectors will momentarily click, then individual injectors will click in sequence 1 through 8.

Injector Trouble Codes	
-------------------------------	--

» If self test codes are retrieved, go to appropriate PPT.

7. Intake Restriction

- Check filter minder switch/indicator.
- Measure vacuum on clean side of air inlet system at WOT with magnehelic gauge.

Instrument	Spec.	Check
Magnehelic/ Filter Minder	2"-25" H ² O	

8. EGR Position

- Perform with key on, engine off.
- Use scan tool to command Output State Control for EGR.
- Monitor EGR position sensor PID and calculate travel..

Instrument	Spec. Percent	Actual Percent
Scan tool	0% (0.6-1.2 V) Closed	_____ Closed
	90% - 100% (4.0-4.52 V) Open	_____ Open
	90% and 3.2 V Travel	_____ Travel

» Repair issue causing out of spec. values before continuing.

9. Exhaust Restriction

- Visually inspect exhaust system for damage
- Monitor EP with the scan tool with the engine temperature at 70° C (170° F) minimum at 3,800 RPM in park/neutral.

Parameter	Spec.	Measurement
EP	234 kPa (34 PSI) MAX ' @ 3800 RPM	

10a. Electric Fuel Pump Pressure

- Measure fuel pressure at engine filter housing test port.
- Road Test- engine at full load condition

Instrument	Spec.	Measurement
0-1.1 Mpa (0-160 PSI) Gauge	310-379 kPa (45-55 PSI) min.	

» If fuel pressure fails low, Go to step10b.
 » If pressure is above spec, check fuel return lines for restriction.
 If no restriction is present, replace fuel pressure regulator valve.

10b. Electric Fuel Pump Inlet Restriction

- Measure restriction at fuel pump inlet.

Instrument	Spec.	Measurement
0-30 " Hg vacuum	6" Hg MAX	

» If > 6" Hg restriction, check lines between pump and fuel tank.
 » If < 6" Hg, inspect both fuel filters. If filters are OK, check fuel regulator. If regulator and filters are OK, replace fuel pump.

10c. Fuel Aeration Test

- Install clear hose on fuel return line at fuel control module.
- Refer to shop manual for approved procedure.
- Run at WOT for 2 min. Return fuel should be free of bubbles.

Method	Check
Visual	

» If air is present in return fuel, inspect fuel system for leaks.

11. Perform KOER On Demand Test

- This will test the ICP, EGR and VGT performance.

KOER DTC	
-----------------	--

12a. Low Idle Stability (ICP Pressure)

- Check at low idle, EOT above 70° C (170° F)
- Monitor ICP and RPM with scan tool.

Parameter	Spec. @ 670 RPM	Measurement
ICP	4.5-5.5 Mpa ± .3MPa (650-800 PSI ± 45 PSI)	

Take reading before disconnecting ICP

If engine RPM is unstable, disconnect ICP sensor (ICP will default).
 » If RPM is still unstable, re-connect sensor and go to 12b.
 » If RPM smoothes out, the ICP sensor is at fault.

12b. Injection Pressure Regulator Test

- Check at low idle, EOT above 70° C (170° F)
- Monitor IPR with scan tool.

Parameter	Spec. @ 670 RPM	Measurement
IPR	30% MAX	

» If duty cycle is below MAX spec go to next step.
 » If duty cycle is above MAX spec, check for system leak with procedure in Hard Start/No Start section. Test 10c.

13. Boost Pressure Test

- Carefully inspect intercooler tubes/connections, turbocharger connections, and MAP hose for signs of damage or leaks.
- Perform boost test at 3300 RPM.
- Monitor MGP and RPM with scan tool.
- Road Test - select appropriate gear to obtain desired engine speed and full load on engine climbing hill or loaded truck..

3300 RPM		
Parameter	Spec. PSI G	Measurement
MGP	22 PSIG MIN	

» If test fails low, inspect turbo blades for damage.

14. Crankcase Pressure Test

- Measure at oil fill tube with 6.0L Crankcase Pressure Tester p/n 303-758, with engine at 70° C (170° F) minimum.
- Block breather tube on left valve cover.
- Measure at WOT with no load at 3,000 RPM.

Instrument	Spec.	Measurement
(0-60" H ² O) Magnehelic	8" H ² O MAX	

If more than 8" H²O, refer to base engine in Shop Manual

15. Oil Aeration Test

- Run engine at 3000 RPM for 1 minute.
- Take oil sample from the Oil Pressure Switch port at idle.
- Inspect sample for presence of air bubbles.

Method	Check
Visual	

» Excessive oil aeration can be caused by depleted oil additives, pick-up tube leak, front cover seal leak, or upper pan seal leak.

Note: If performance concern still exists, refer to Enhanced Injector Diagnostics in this section.

See PC/ED manual, Section 4A for more detail on all of the above test steps

When troubleshooting a Hard Start/No Start or Performance concern, this form must be filled out to the point of repair and returned to receive warranty credit and diagnostic time for the following parts:
 Fuel Injectors (9E527), regulator-injection control pressure(9C968), pump assembly high pressure oil (9A543), turbo charger assembly/pedestal (6K684), fuel pump (9350), FICM (12B599) and PCM (EEC)(12A650
 Labor operations listed more than once are a continuation of the diagnostic procedure and should be claimed only once.

What problems were found and what repairs were performed?

List Part Name, Number and Serial Number of parts replaced.

WIRING DIAGRAM (SINGLE ALT.)

Engine Mounted Components

SENSORS

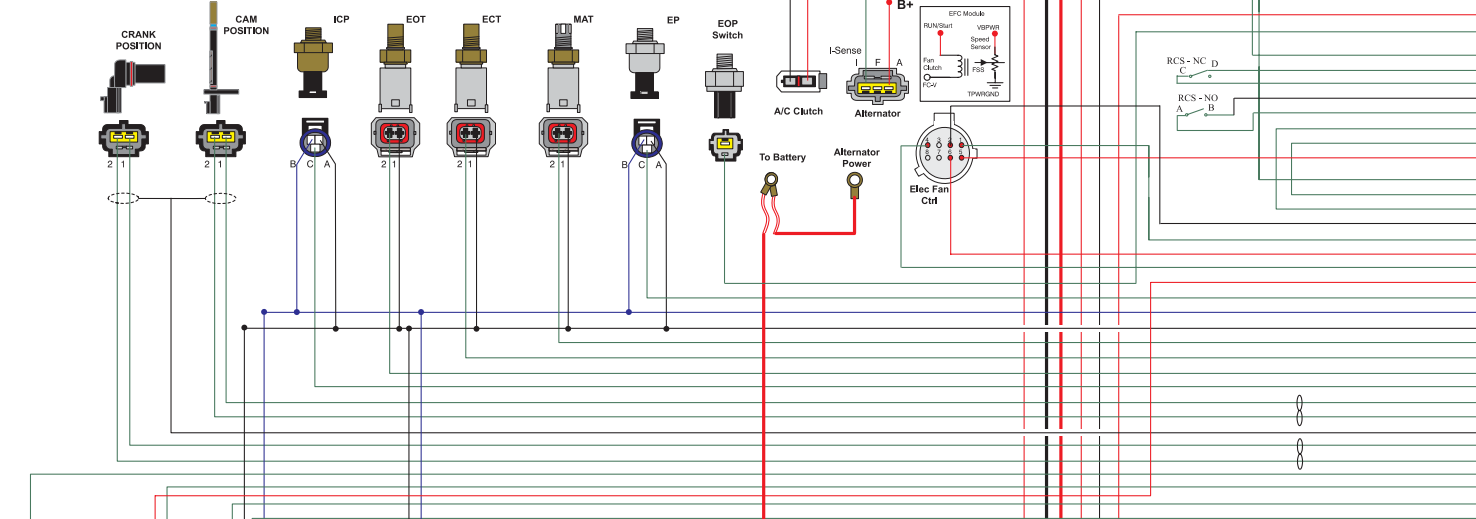

ACTUATORS

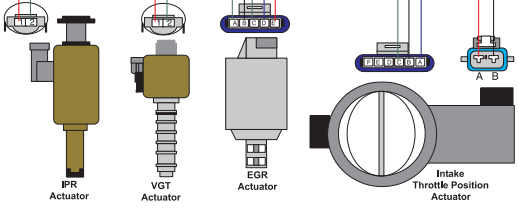

- (Orientation = Looking into terminals on connector)
- PURPLE = V inj (48 VOLTS)
 - Lt. BLUE = V ref (5 VOLTS)
 - GREEN = SIGNAL CIRCUIT
 - Dk Blue = Data Communication Link
 - BLACK = GROUND CIRCUIT
 - RED = 12 VOLTS (V Batt)
 - ★ ★ Gold Plated Pins

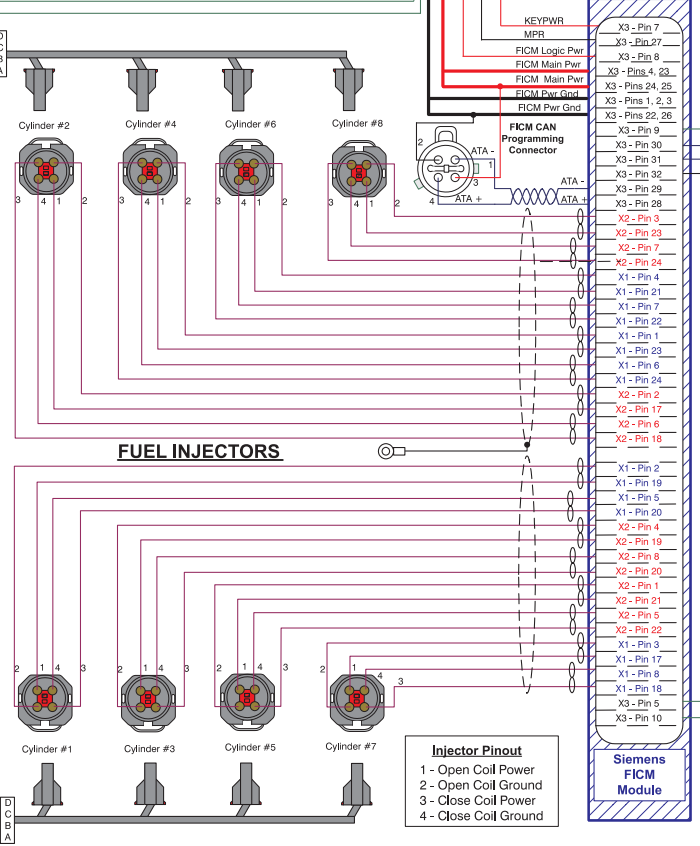

FUEL INJECTORS

- Injector Pinout**
- 1 - Open Coil Power
 - 2 - Open Coil Ground
 - 3 - Close Coil Power
 - 4 - Close Coil Ground

KEYPWR	X3 - Pin 7
MPR	X3 - Pin 27
FICM Logic Pwr	X3 - Pin 8
FICM Main Pwr	X9 - Pins 4, 23
FICM Main Pwr	X3 - Pins 24, 25
FICM Pwr Gnd	X3 - Pins 1, 2, 3
FICM Pwr Gnd	X3 - Pins 22, 26
	X3 - Pin 9
	X3 - Pin 30
	X3 - Pin 31
	X3 - Pin 32
	X3 - Pin 29
	X3 - Pin 28
	X2 - Pin 3
	X2 - Pin 23
	X2 - Pin 7
	X2 - Pin 24
	X1 - Pin 4
	X1 - Pin 21
	X1 - Pin 7
	X1 - Pin 22
	X1 - Pin 1
	X1 - Pin 23
	X1 - Pin 6
	X1 - Pin 24
	X2 - Pin 2
	X2 - Pin 17
	X2 - Pin 6
	X2 - Pin 18
	X1 - Pin 2
	X1 - Pin 19
	X1 - Pin 5
	X1 - Pin 20
	X2 - Pin 4
	X2 - Pin 19
	X2 - Pin 8
	X2 - Pin 20
	X2 - Pin 1
	X2 - Pin 21
	X2 - Pin 5
	X2 - Pin 22
	X1 - Pin 3
	X1 - Pin 17
	X1 - Pin 8
	X1 - Pin 18
	X3 - Pin 5
	X3 - Pin 10

Siemens
FICM
Module

WIRING DIAGRAM (SINGLE ALT.)

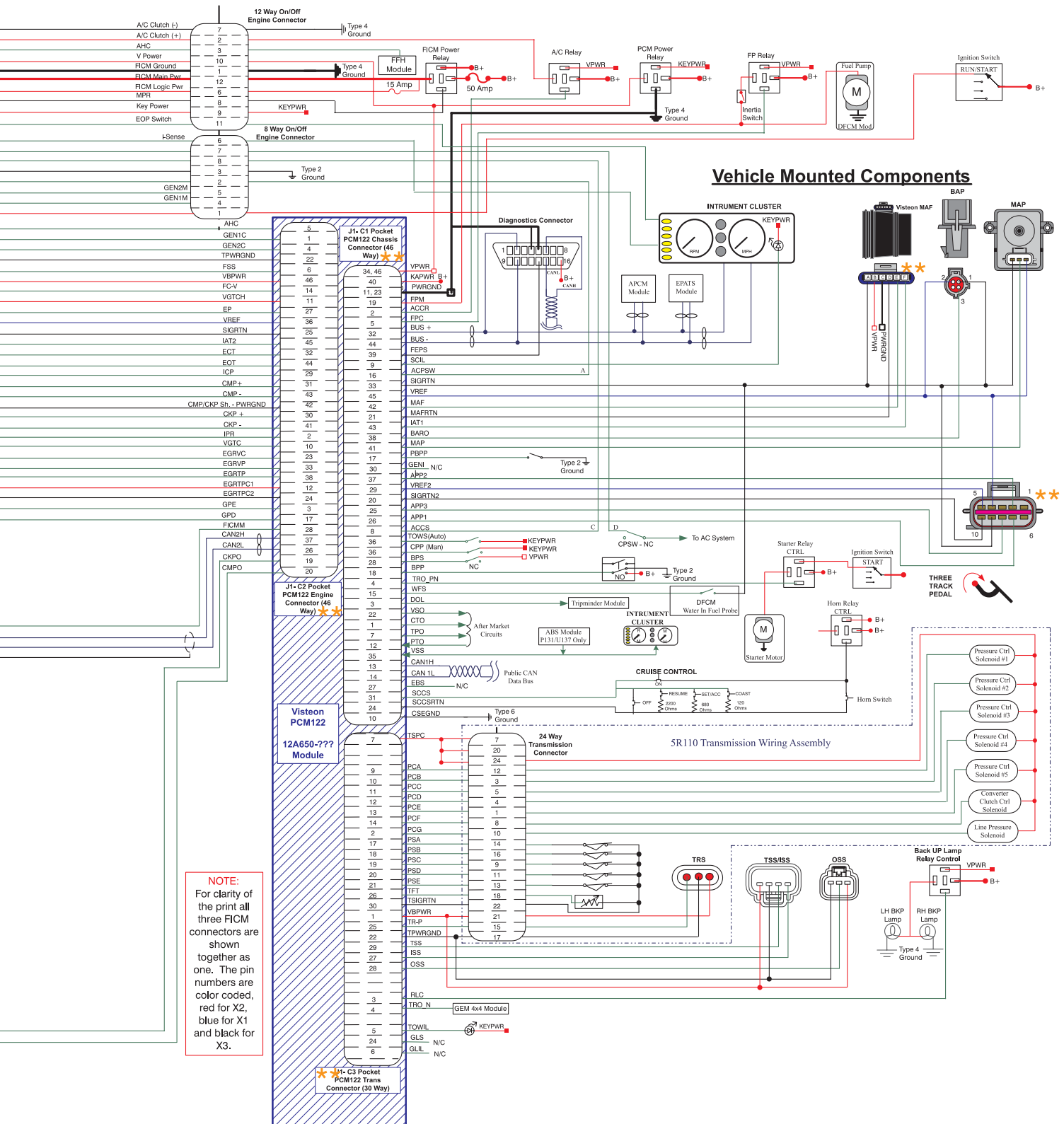

WIRING DIAGRAM (DUAL ALT.)

Engine Mounted Components

SENSORS

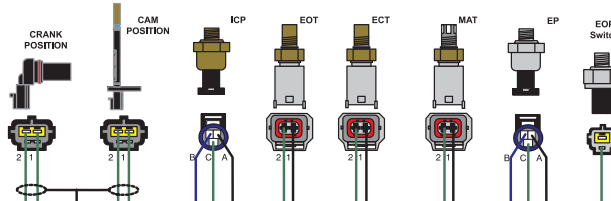

ACTUATORS

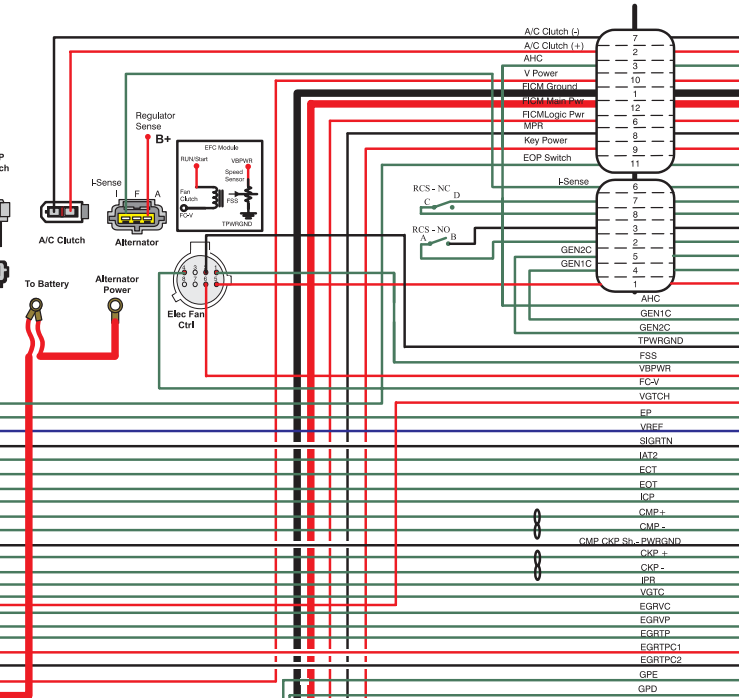
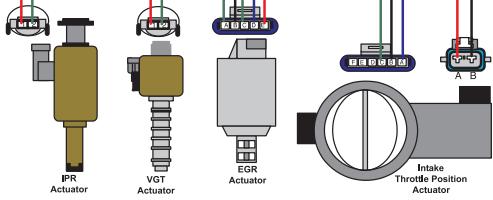

FUEL INJECTORS

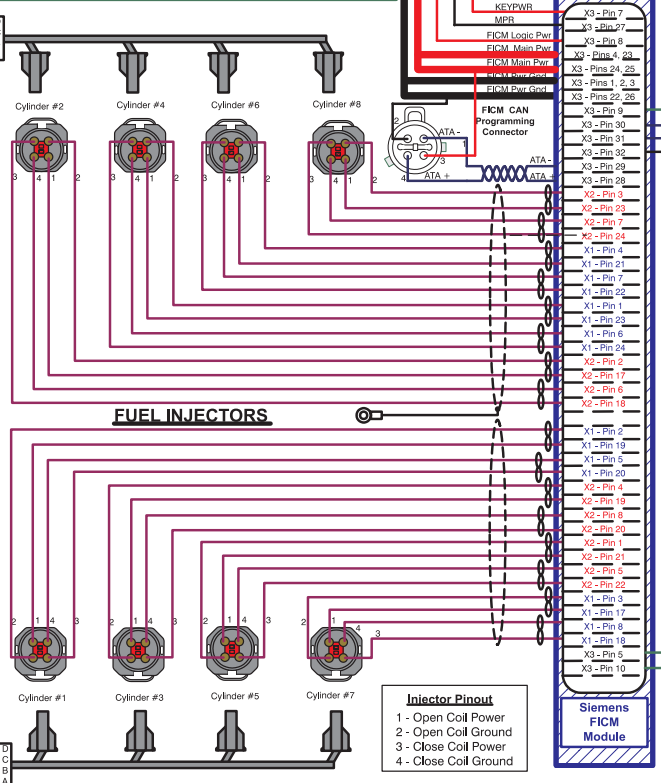

(Orientation = Looking into terminals on connector)
PURPLE = V_{ini} (48 VOLTS)
LT BLUE = V_{ref} (5 VOLTS)
GREEN = SIGNAL CIRCUIT
Dk Blue = Data Communication Link
BLACK = GROUND CIRCUIT
RED = 12 VOLTS (V_{Batt})
 ★ Gold Plated Pins.

Injector Pinout
 1 - Open Coil Power
 2 - Open Coil Ground
 3 - Close Coil Power
 4 - Close Coil Ground

NOTE:
 For clarity of the print all three FICM connectors are shown together as one. The pin numbers are color coded, red for X2, blue for X1 and black for X3.

DIAGNOSTIC CODES

C - Continuous Operation				* - MIL (Malfunction Indicator Light) Illuminates	
O - Self Test - Key On Engine Off(KOEO)				^ - Tow/Haul Light flashes	
R - Self Test - Key On Engine Running(KOER)				[] - Assigned but not used	
DTC	How SET	Condition Description	Fault Trigger/Comments	Probable Causes	
P0046	C* O R	Turbo Boost Control Solenoid Circuit Range/Performance	Internal to PCM. VGT Actuator Circuit check.	Diagnostic circuit associated with 1 Amp driver checks for open circuit, short to ground, and short to power.	
P0069	C*	MAP/BARO Correlation	30 kPa (4.4 PSI)/Compares BP and MAP at idle.	VGT, BP, MAP, EGR - System Fault, Biased Sensor, Circuit Integrity.	
P0096	C*	Intake Air Temperature Sensor 2 Circuit Range/Performance	5 deg. C (41 deg F)/Checks for Minimum Change in IAT2	IAT 2 Biased Sensor, System Fault, PCM.	
P0097	C* O R	Intake Air Temperature Sensor 2 Circuit Low Input	EGR disabled, less than 0.15v	MAT signal circuit, shorted to ground or defective sensor.	
P0098	C* O R	Intake Air Temperature Sensor 2 Circuit High Input	EGR disabled, greater than 4.8v	MAT signal circuit, open, short to power or defective sensor.	
P0101	C*	Mass or Volume Air Flow Circuit Range/Performance	Indicates an MAF range/performance problem was detected during normal driving conditions when MAF is enabled. 4.0 Volts when RPM is less than 1500, 4.9 volts when RPM is greater than 1500 rpm.	Damaged MAF sensor-plugged or restricted sensor supply tube-MAF, PCM.	
P0102	C*	Mass or Volume Air Flow Circuit Low Input	Indicates MAF sensor circuit low input was detected during KOEO Self Test or during continuous diagnostic monitoring. MAF voltage less than 0.35 volts.	Open MAF sensor circuit-biased sensor, PCM-short to SIGN RTN or PWR GND on MAF sensor circuit-open in VREF circuit.	
P0103	C* O R	Mass or Volume Air Flow Circuit High Input	Indicates MAF sensor circuit high input detected during KOEO On-Demand Self Test or during continuous diagnostic monitoring. MAF voltage is greater than 4.95 volts.	Biased sensor, PCM-MAF circuit shorted to VREF.	
P0107	C* O	Manifold Absolute Pressure/BARO Sensor Low Input	Checks BP for a signal lower than a specified barometric pressure expected for normal operations when BP is less than 0.04 volts. Default 101 kpa (14.6 PSI).	Circuit is open, shorted to ground.	
P0108	C* O	Manifold Absolute Pressure/BARO Sensor High Input	Checks BP for a signal greater than a specified barometric pressure expected for normal operations when BP is greater than 4.9 volts. Default 101 kpa (14.6 PSI).	Circuit is shorted to power.	
P0112	C* O R	Intake Air Temperature Circuit Low Input	Checks sensor output for a value higher than a maximum probable temperature when IAT voltage is less than 0.15 volts. Default 77°F/25°C.	Short to ground.	
P0113	C* O R	Intake Air Temperature Circuit High Input	Checks sensor output for a value lower than a minimum probable temperature when IAT voltage is greater than 4.9 volts. Default 77°F/25°C.	Open circuit, short to power.	
P0117	C* O R	Engine Coolant Temperature Circuit Low Input	Checks ECT for a temperature higher than a specified oil temperature expected for normal operation when ECT voltage is greater than 0.15 volts. Default 180oF/82oC - no fast idle.	Short to ground on the circuit.	
P0118	C* O R	Engine Coolant Temperature High Input	Checks ECT for a temperature lower than a specified oil temperature expected for normal operation when ECT voltage is greater than 4.78 volts. Default 180oF/82oC - no fast idle.	Open in circuit, short to power.	
P0148	C	Fueling Error	Engine RPM has exceeded requested RPM.	Alternative fuel source, Interference on CKP & CMP, Faulty PCM.	
P0196		Engine Oil Temperature Sensor Circuit Range/Performance	Checks for an EOT temperature signal which is unable to reach the EOT cold minimum limit within a specified amount of time. Function of initial EOT. (in-range fault based off of a change in EOT and MFDES)	Faulty, Biased sensor, circuit fault, PCM.	
P0197	C* O R	Engine Oil Temperature Sensor Circuit Low Input	Checks EOT for a temperature higher than a specified oil temperature expected for normal operations WHEN eot VOLTAGE IS LESS THAN 0.15 VOLTS. Default 212°F/100°C - no fast idle.	Shorted to ground on the circuit.	
P0198	C* O R	Engine Oil Temperature Sensor Circuit High Input	Checks EOT for a temperature lower than a specified oil temperature expected for normal operations when EOT voltage is greater than 4.76 volts. Default 212°F/100°C - no fast idle.	Open in circuit, short to power.	
P0219	C	Engine Overspeed Condition	PCMrecorded excessive engine speed greater than 4300 rpm for more than 5 seconds.	Improper downshift, Interference on CKP & CMP, Faulty PCM	
P0230	C O R	Fuel Pump Primary Circuit	Fuel Pump Relay driver failure.	Open control circuit, failed fuel pump relay or PCM.	
P0231	C O R	Fuel Pump Secondary Circuit Low	No voltage present at the Fuel Pump monitor circuit when it has been commanded "on" for more than 1 second.	Indicates open, short circuit, relay, inertia switch or fuel pump.	
P0232	C O R	Fuel Pump Secondary Circuit High	Voltage present at the Fuel Pump monitor circuit when it has NOT been commanded "on" for more than 1 second.	Indicates short to power, sticking relay.	
P0236	C* O	Turbo/Super Charger Boost Sensor A Circuit Range/Performance	Default inferred MAP - low power, slow acceleration, greater than 120kpa(2.7 PSI) at low idle.	MAP sensor plugged, defective sensor.	
P0237	C* O R	Turbo/Super Charger Boost Sensor A Circuit Low	Default inferred MAP - low power, slow acceleration, MAP voltage is less than 0.039 volts.	MAP circuit short to ground or open, defective sensor.	
P0238	C* O R	Turbo/Super Charger Boost Sensor A Circuit High	Default inferred MAP - low power, slow acceleration, MAP voltage is greater than 4.91 volts.	MAP circuit short to Vref or Vbat, defective sensor.	
P0261	C* O R	Cylinder #1 Injector Circuit Low	FICM detected a short in an injector circuit to ground.	Injector circuit short to ground, defective coil.	
P0262	C O R	Cylinder #1 Injector Circuit High	FICM detected an open injector circuit.	Injector circuit open, defective coil.	
P0264	C* O R	Cylinder #2 Injector Circuit Low	FICM detected a short in an injector circuit to ground.	Injector circuit short to ground, defective coil.	
P0265	C O R	Cylinder #2 Injector Circuit High	FICM detected an open injector circuit.	Injector circuit open, defective coil.	
P0267	C* O R	Cylinder #3 Injector Circuit Low	FICM detected a short in an injector circuit to ground.	Injector circuit short to ground, defective coil.	
P0268	C O R	Cylinder #3 Injector Circuit High	FICM detected an open injector circuit.	Injector circuit open, defective coil.	
P0270	C* O R	Cylinder #4 Injector Circuit Low	FICM detected a short in an injector circuit to ground.	Injector circuit short to ground, defective coil.	
P0271	C O R	Cylinder #4 Injector Circuit High	FICM detected an open injector circuit.	Injector circuit open, defective coil.	
P0273	C* O R	Cylinder #5 Injector Circuit Low	FICM detected a short in an injector circuit to ground.	Injector circuit short to ground, defective coil.	
P0274	C O R	Cylinder #5 Injector Circuit High	FICM detected an open injector circuit.	Injector circuit open, defective coil.	
P0276	C* O R	Cylinder #6 Injector Circuit Low	FICM detected a short in an injector circuit to ground.	Injector circuit short to ground, defective coil.	
P0277	C O R	Cylinder #6 Injector Circuit High	FICM detected an open injector circuit.	Injector circuit open, defective coil.	
P0279	C* O R	Cylinder #7 Injector Circuit Low	FICM detected a short in an injector circuit to ground.	Injector circuit short to ground, defective coil.	
P0280	C O R	Cylinder #7 Injector Circuit High	FICM detected an open injector circuit.	Injector circuit open, defective coil.	

DIAGNOSTIC CODES

P0341	C*	R	Camshaft Position Sensor A Circuit Range/Performance (Bank 1 or single sensor)	CMP signal intermittent.	Poor connection, defective sensor, electrical noise.
P0381	C*	O	Glow Plug/Heater Indicator Circuit	Indicator Circuit Check - Instrument cluster driver checks for open circuit, or short circuit when lamp turns on and off.	Open/Short circuit, lamp, fuse, PCM.
P0401	C*		Exhaust Gas Recirculation Flow Insufficient Detected	EGR Valve Position does not match desired, limits based on engine speed / load.	EGR Valve stuck or sticking - EGR Valve Position Sensor Bias - EP Sensor bias.
P0402	C*		Exhaust Gas Recirculation Flow Excessive Detected	EGR Valve Position does not match desired, limits based on engine speed / load.	EGR Valve stuck or sticking - EGR Valve Position Sensor Bias - EP Sensor bias.
P0403	C*	O R	Exhaust Gas Recirculation Control Circuit	EGR actuator circuit check. Diagnostic circuit associated with 1 Amp driver Internal to PCM.	Open circuit, short to ground, and short to power.
P0404	C*		Exhaust Gas Recirculation Control Circuit Range/Performance	+/- 0.10 EGRP error from commanded to actual EGRP during normal driving conditions.	Faulty EGR sensor, valve or PCM integrity of EGR position circuit.
P0405	C*	O R	Exhaust Gas Recirculation Sensor A Circuit Low	EGR is disabled when EGR voltage is less than 0.30 volts.	EGRP circuit short to ground or open, defective sensor.
P0406	C*	O R	Exhaust Gas Recirculation Sensor A Circuit High	EGR is disabled when EGR voltage is greater than 4.9 volts.	EGRP circuit short to Vref or Vbat, defective sensor.
P0460	C	O R	Fuel Level Sensor Circuit	Fuel Level Indicator (FLI) Circuit Check - Instrument cluster driver checks for open circuit, or short circuit.	"REFER to the appropriate section in the Workshop Manual."
P0470		O	Exhaust Pressure Sensor	Maximum EP when the engine is not running 150 kpa (21.8 PSI) absolute.	Faulty EP Sensor, PCM.
P0471	C*		Exhaust Pressure Sensor Range/Performance	Minimum EP when the engine is running, Pressure difference of +/-10 kPa (1.5 PSI) from desired.	Faulty EP Sensor, PCM or VGT.
P0472	C*	O R	Exhaust Pressure Sensor Low Input	EGR disabled, default inferred for VGT operation when EGR voltage is less than 0.03 volts.	EP circuit is short to ground or open, defective sensor.
P0473	C*	O R	Exhaust Pressure Sensor High Input	EGR disabled, default inferred for VGT operation when EGR voltage is greater than 4.8 volts.	EP circuit is short to Vref or Vbat, defective sensor.
P0478	C*		Exhaust Pressure Control Valve High Input	EP is higher than EP desired by 260 kpa (37.7 PSI) for greater than 30 seconds.	Faulty EP sensor, VGT control valve slow to respond, Stuck VGT valve, faulty PCM.
P0480	C	R	Fan 1 Control Circuit		
P0500	C		Vehicle Speed Sensor A	Vehicle speed sensor malfunction.	Sensor, circuit, PSM, PSOM, low transmission fluid.
P0562	C*	O R	System Voltage Low	PCM voltage less than 7v - cause of no start/misfire.	Low Vbat, loose connections/resistance in circuit, Vref engine concerns.
P0563	C	O R	System Voltage High	PCM voltage continuously more than 23.3v.	Charging system fault.
P0565	C	O R	Cruise Control ON Signal	KOER switch test(code set if cruise not present).	
P0566	C	O R	Cruise Control OFF Signal	KOER switch test(code set if cruise not present).	
P0567	O		Cruise Control RESUME Signal	KOER switch test(code set if cruise not present).	
P0568	O		Cruise Control SET Signal	KOER switch test(code set if cruise not present).	Open or short circuit, switch failure, PCM failure or failed to activate switch during KOER switch test. (code will set if cruise is not present)
P0569	O		Cruise Control COAST Signal	KOER switch test(code set if cruise not present).	
P0571	O		Brake Switch A Circuit	Brake switch A circuit malfunction	Cruise control code will be set on every switch test on vehicles not equipped with cruise control
P0602	C	O R	Powertrain Control Module Programming Error		
P0603	C		Powertrain Control Module Keep Alive Memory (KAM) Error	No historical faults output during self test.	Disconnected/Discharged Battery, Open PCM pin, faulty PCM.
P0605		O	Powertrain Control Module Read Only Memory (ROM) Error	PCM failure	Defective PCM.
P0615	C	O R	Starter Relay Circuit		
P0620	C	O R	Generator 1 Control Circuit		
P0623	C	O R	Generator Lamp Control Circuit		
P0645	C	O R	A/C Clutch Relay Control Circuit		
P0649	C	O R	Cruise Control Lamp Control Circuit		
P0670	C*	O R	Glow Plug Module Control Circuit	Glow plug control module control line failure	Open/grounded circuit, open/shorted GPCM, failed PCM
P0671	C*	O R	Cylinder 1 Glow Plug Circuit	Glow plug #1 failure	Open/shorted circuit, faulty glow plug, failed GPCM
P0672	C*	O R	Cylinder 2 Glow Plug Circuit	Glow plug #2 failure	Open/shorted circuit, faulty glow plug, failed GPCM
P0673	C*	O R	Cylinder 3 Glow Plug Circuit	Glow plug #3 failure	Open/shorted circuit, faulty glow plug, failed GPCM
P0674	C*	O R	Cylinder 4 Glow Plug Circuit	Glow plug #4 failure	Open/shorted circuit, faulty glow plug, failed GPCM
P0675	C*	O R	Cylinder 5 Glow Plug Circuit	Glow plug #5 failure	Open/shorted circuit, faulty glow plug, failed GPCM
P0676	C*	O R	Cylinder 6 Glow Plug Circuit	Glow plug #6 failure	Open/shorted circuit, faulty glow plug, failed GPCM
P0677	C*	O R	Cylinder 7 Glow Plug Circuit	Glow plug #7 failure	Open/shorted circuit, faulty glow plug, failed GPCM
P0678	C*	O R	Cylinder 8 Glow Plug Circuit	Glow plug #8 failure	Open/shorted circuit, faulty glow plug, failed GPCM
P0683	C*	O R	Glow Plug Control Module to PCM Communication Circuit	GPCM glow plug control module communication line failure	Open/shorted circuit, failed GPCM, failed PCM
P0684	C*	O R	Glow Plug Control Module to PCM Communication Circuit Range/Performance	Noise was detected in the GPCM communication line	Noise in GPD line
P0700	C	O R	Transmission Control System (MIL Request)		
P0703		R	Brake Switch B Input Circuit	KOER switch test.	Open/short circuit, switch, PCM, failed to activate during KOER switch test.
P0704	C	R	Clutch Switch Input Circuit	KOER switch test.	Open/short circuit, switch, PCM, failed to activate during KOER switch test.
P1000	C	O R	OBD Systems Readiness Test Not Complete	Drive cycle is not complete.	
P1001	R		KOER not able to complete, KOER aborted	Conditions not met.	A/C, Parking Brake, Clutch, PRNDL, (EOT, ETC.)
P1139	C	O R	Water in Fuel Indicator Circuit	Indicates falt in circuit.	Faulty sensor, Open or Short in circuit.
P1148	C*	O R	Generator 2 Control Circuit		
P1149	C	O R	Generator 2 Control Circuit High		
P1184		R	Engine Oil Temperature Sensor Out Of Self Test Range	Engine not warm enough to run KOEO CCT - aborts test.	Engine not warm enough, leaking thermostat, circuit failure.
P1260	C		Theft Detected, Vehicle Immobilized		
P1284		R	Aborted KOER - Injector Control Pressure Regulator	ICP failure--Aborts KOER CCT test	See codes P2284, P2285, P2286, P2288, P2623
P1378	C	O R	FICM Supply Voltage Circuit Low	IDM detects logic power low, less than 7 volts.	Low batteries, loose connections/resistance in circuit, defective relay
P1379	C	O R	FICM Supply Voltage Circuit High	IDM detects excessive voltage, greater than 16 volts.	Charging system fault.
P1397		R	System Voltage Out Of Self Test Range		Voltage too high or low for glow plug monitor test
P1408		R	Exhaust Gas Recirculation Flow Out Of Self Test	EGRC output circuit check - engine off test only	EGR Control circuit open. short to Vref. Vbat. around. defective coil.

DIAGNOSTIC CODES

P1703	O	R	Brake Switch Out Of Self Test Range		
P1705	O	R	Transmission Range Circuit Not Indicating Park/Neutral During Self Test	Not in park during KOEO or KOER.	Operator error, circuit failure, faulty sensor, PCM.
P1725		R	Insufficient engine speed increase during self test.		
P1726		R	Insufficient engine speed decrease during self test.		
P2121	C	O R	Throttle/Pedal Position Sensor/Switch D Circuit Range/Performance		
P2122	C	O R	Throttle/Pedal Position Sensor/Switch D Circuit Low Input		
P2123	C	O R	Throttle/Pedal Position Sensor/Switch D Circuit High Input		
P2124	C	O R	Throttle/Pedal Position Sensor/Switch D Circuit Intermittent		
P2126	C	O R	Throttle/Pedal Position Sensor/Switch E Circuit Range/Performance		
P2127	C	O R	Throttle/Pedal Position Sensor/Switch E Circuit Low Input		
P2128	C	O R	Throttle/Pedal Position Sensor/Switch E Circuit High Input		
P2129	C	O R	Throttle/Pedal Position Sensor/Switch E Circuit Intermittent		
P2131	C	O R	Throttle/Pedal Position Sensor/Switch F Circuit Range/Performance		
P2132	C	O R	Throttle/Pedal Position Sensor/Switch F Circuit Low Input		
P2133	C	O R	Throttle/Pedal Position Sensor/Switch F Circuit High Input		
P2134	C	O R	Throttle/Pedal Position Sensor/Switch F Circuit Intermittent		
P2138	C*	O R	Throttle/Pedal Position Sensor/Switch D / E Voltage Correlation		Pedal Sensors will use SAE D,E,F codes
P2139	C*	O R	Throttle/Pedal Position Sensor/Switch D / F Voltage Correlation		Pedal Sensors will use SAE D,E,F codes
P2140	C*	O R	Throttle/Pedal Position Sensor/Switch E / F Voltage Correlation		Pedal Sensors will use SAE D,E,F codes
P2199	C*		Intake Air Temperature 1/2 Correlation	Correlation between IAT1 and IAT2 are not at expected values	Open/shorted circuit, bias sensor, PCM
P2262	C		Turbo/Super Charger Boost Pressure not Detected - Mechanical	No boost pressure increase was detected	MAP hose, MAP sensor, CAC system leaks, Intake leaks, EP sensor, exhaust restriction
P2263	C		Turbo/Super Charger System Performance		MAP hose, MAP sensor, CAC system leaks, Intake leaks, EP sensor, exhaust restriction, exhaust leaks
P2269	C	O R	Water in Fuel Condition	Indicates water in fuel.	Drain water in fuel separator, defective WIF sensor, circuit integrity.
P2284	C	R	Injector Control Pressure Sensor Circuit Range/Performance	Default inferred ICP, ICP desired does not equal ICP signal, difference of 362psi/2.5mpa.	See diagnostic manual - ICP system.
P2285	C	O R	Injector Control Pressure Sensor Circuit Low	Default open loop control - underrun at idle, ICP is less than 0.04 volts.	ICP circuit short to ground or open, defective sensor.
P2286	C	O R	Injector Control Pressure Sensor Circuit High	Default open loop control - underrun at idle, ICP is greater than 4.91 volts.	ICP circuit short, Vref or Vbat, defective sensor.
P2288	C	R	Injector Control Pressure Too High	Default inferred ICP is used, ICP is greater than 3675psi/25mpa.	See diagnostic manual - ICP system.
P2289	C	O	Injector Control Pressure Too High - Engine Off	Default inferred ICP, KOEO ICP is greater than	ICP signal ground, circuit open, defective sensor.
P2290	C	O	Injector Control Pressure Too Low	Default inferred ICP is used, ICP is below desired pressure	See diagnostic manual - ICP system.
P2291	C		Injector Control Pressure Too Low - Engine Cranking	No start ICP is less than 725psi/5mpa.	See diagnostic manual - ICP system
P2552	C	O R	FICMM Circuit - Throttle/Fuel Inhibit Circuit	No signal from the FICM Monitor circuit	Circuit open/short, FICM, PCM
P2614	C	O R	Camshaft Position Output Circuit	CMPO signal intermittent	Poor connection, electrical noise. In CMPO from PCM
P2617	C	O R	Crankshaft Position Output Circuit	CKPO signal intermittent	Poor connection, electrical noise. In CKPO from PCM
P2623	C	O R	Injector Control Pressure Regulator Circuit	IPR circuit failure	Open/grounded circuit, stuck IPR, loose connection

Actuator

A device which delivers motion in response to an electrical signal.

Analog

A continuously variable voltage.

APS Accelerator Position Sensor

A potentiometer style sensor that indicates the operator's pedal position.

AWA Feature

A feature built into the high pressure oil rails used to dampen noises that can be caused by the hydraulic system.

BARO Barometric Pressure Sensor

An analog device which indicates atmospheric pressure which allows the PCM to compensate for altitude. A BARO sensor has three connections, signal return(gnd), BARO signal, and Vref.

CAC Charge Air Cooling

A process of cooling the air coming out of the turbocharger before it enters the engine.

Canister Style Oil Filter

An oil filter that requires only the element be replaced and not the housing.

CAN

A communication protocol for data transfer between the control modules.

CKP Crankshaft Position Sensor

A magnetic pickup sensor that creates a sine wave voltage when the timing wheel on the crankshaft breaks its magnetic field. The CKP determines crankshaft position and speed.

Closed Crankcase Breather

A ventilation system that recirculates crankcase vapors into the intake air system.

CMP Camshaft Position Sensor

A magnetic pickup sensor that creates a sine wave voltage when a peg on the camshaft breaks its magnetic field. The CMP determines which cycle the piston is in (compression or exhaust).

Combination Fuel Pump/Power Steering Pump

A fuel pump and power steering pump that are made into one unit and driven off of the rear gear train.

Digital Fuel Injection

A fuel injection system that uses both an open and close signal to control fuel injectors.

Dual Timing System

A timing System that uses both a CKP and CMP sensors to determine engine speed and rotational position.

DVOM Digital Volt Ohm Meter

A meter that uses a digital display to indicate a measured value. Preferred for use on microprocessor systems because a DVOM has a very high internal impedance and will not load down the circuit being measured.

PCM Powertrain Control Module

The housing which contains the micro computer, Vref regulator, input conditioners and output drivers.

ECT Engine Coolant Temperature Sensor

A thermistor style sensor used to indicate engine coolant temperature.

EGR Cooler

A device used to cool exhaust gases before they are returned to the intake air system.

EGR Exhaust Gas Recirculation Valve

A valve used to control the flow of exhaust gases into the intake manifold.

EGRP Exhaust Gas Recirculation Valve Position Sensor

A potentiometer style sensor that indicates the amount of movement of the EGR valve.

EOP Engine Oil Pressure Sensor

A variable capacitance style sensor used to indicate engine oil pressure.

EOT Engine Oil Temperature

A thermistor type sensor which indicates engine temperature.

EVRT Control Valve

See VGTCV Variable Geometry Turbocharger Control Valve.

EVRT

See VGT Variable Geometry Turbocharger.

FICM Fuel Injection Control Module

An electronic unit which has the primary function of an electronic distributor for the injectors. It also is the power supply for the injectors.

GLOSSARY

Glow Plug Sleeves

Stainless steel sleeves used to protect the glow plugs from coolant.

GPCM Glow Plug Control Module

Module which supplies power to the glow plugs and identifies variation in current flow to the glow plugs.

IAT Intake Air Temperature Sensor

A thermistor style sensor used to indicate air temperature before the charge air cooler.

ICP Injection Control Pressure

A variable capacitance style sensor used to indicate high pressure oil system pressure.

IAT2 Intake Air Temperature 2 Sensor

A thermistor style sensor used to indicate air temperature after passing through the charge air cooler.

IDM Injector Driver Module

An electronic unit which has the primary function of an electronic distributor for the injectors. It also is the power supply for the injectors.

Impedance

A form of opposition to AC current flow measured in Ohms.

I/O Injector Test

A test that can be performed using the WDS to disable one injector at a time while watching Mfdes to determine a weak contributing injector.

IPR Injection Pressure Regulator

Controls injection oil pressure. An electrical signal to a solenoid creates a magnetic field which applies a variable force on a poppet to control pressure. The quantity of fuel delivered to the combustion chamber is proportional to injection control pressure.

IVS Idle Validation Switch

An on/off switch that indicates when the accelerator pedal is in the idle position.

KOEO Key on Engine Off Test

A self-test operation that is performed with the ignition switch in the ON position with the engine OFF.

KOER Key on Engine Running Test

A self-test operation that is performed with the ignition switch in the ON position and the engine RUNNING.

Long Life Ethylene Glycol Coolant

A premium coolant, with an Ethylene Glycol base, that can be used in a cooling system for an extended time without needing to be changed. Long life coolants do not require the use of extenders. Long life coolants can be identified by its yellow color.

Main Power Relays

(Two) Battery power relay switches for the ECM and IDM (modules) that are key power initiated and controlled by the corresponding powered module.

MAP Manifold Absolute Pressure

A MAP sensor generates a digital frequency that indicates manifold boost pressure above atmospheric pressure. The signal is created by switching action caused by manifold pressure of a diaphragm connected to a capacitor circuit in the sensor. The digital frequency increases as pressure increases. A MAP sensor has three connection: signal return(gnd), MAP signal, and Vref.

Misfire Detection

Uses engine RPM changes during a firing cycle to determine a low contributing cylinder.

Modular Water Pump

Is a water pump that uses the front cover as a housing and only the hub and impeller are replaceable.

Normally Closed

Refers to a switch or a solenoid that is closed when no control or force is acting on it.

Normally Open

Refers to a switch or a solenoid that is open when no control or force is acting on it.

POT Potentiometer

Converts a mechanical motion to a voltage value. Most often used to sense the position of a component. This sensor works as a variable voltage divider. The wiper arm is mechanically connected to the component desired to be sensed. Potentiometers have three connections: Vref, signal out, and ground.

Pulse Width

The length of time an actuator, such as an injector, remains energized.

Relative Compression Test

A test that can be run with the WDS to measure compression of a cylinder relative to the other cylinders in the engine. This test is accomplished by comparing the rpm of the engine during each compression stroke.

Rocker Arm Carrier

A housing that the rocker arms and their fulcrums are mounted to.

Thermistor

Sensor used to determine temperature. A thermistor changes its resistance value in relation to temperature change. Increasing temperature results in decreasing resistance, decreasing temperature results in increasing resistance. The thermistor in conjunction with a current limiting resistor in the PCM forms a voltage divider that provides a voltage signal indicating temperature. Since the top half of the voltage divider is the current limiting resistor and is internal to the PCM, a thermistor sensor only has two connections, signal return and ground.

Variable Capacitance Sensor

A sensor that is used to determine pressure. A variable capacitance sensor changes its capacitance value in relation to pressure change. Increasing pressure results in a lower capacitance, thus increasing return voltage. Decreasing pressure results in a higher capacitance and a lower voltage. Variable capacitance sensors are 3 wire sensors.

VBAT

Battery voltage.

VGT Variable Geometry Turbocharger

Could also be called EVRT. A turbocharger that has a turbine housing that can change sizes through electronically controlled hydraulics.

VGTCV Variable Geometry Turbocharger Control Valve

Could also be called EVRTC. Controls oil flow in and out of the VGT actuator in order to change the effective size of its turbine housing.

VPWR

Battery voltage.

VSS Vehicle Speed Sensor

Normally a magnetic pickup style sensor that is mounted on the tailshaft of the transmission to indicate ground speed.

INDEX

A

Actuators, 64

Air filter/ filter minder, 33

Air in fuel, 79

Air management system
features, 31
flow, 31-32

AP (Accelerator Pedal), 50

B

BP (Barometric Pressure), 51

Barrel, 44

bed plate, 22

Bridges, 72

C

Charge air cooler, 33

CKP (Crankshaft Position), 52

CMP (Camshaft Position), 53

Component Locations, 9-13

Coolant recovery bottle, 20

Cooling system
Features, 17
Flow, 17-19

Crankcase pressure test, 82

Crankcase ventilation, 74

Crankshaft
Heat treatment discoloration, 15
Primary flange, 78
Rear seal dust cover, 78

Cylinder balance test, 81

Cylinder head, 14
Removal, 72

D

Dual mass flywheel, 15

E

ECT (Engine Coolant Temperature), 54

EGR

Cooler, 37
Installation, 74
Removal, 74
Flow, 37
Throttle, 38
Valve, 37-38
Removal, 73
VP (Valve Position), 55

Electrical Components, 49,65

Emission label, 8

Engine mounted fuel filter, 30

Engine serial number, 8

EOP (Engine Oil Pressure, 56

EOT (Engine Oil Temperature, 57

EP (Exhaust Pressure), 58

F

Features, 6

FICM (Fuel Injection Control Module), 65

Forward, 1

Front cover, 24
Dowel locations, 76
Installation, 77
Removal, 76

Fuel filter replacement, 69

Fuel injector, 43
Coil, 47
End of main injection, 47
Features, 43
Fill cycle, 45
Main injection, 46
O-rings, 43
Spool valve, 43

- Fuel inlet check valves, 30
- Fuel pressure regulator, 30
- Fuel supply system
 - Features, 27
 - Flow, 27-28

- G**
- Generation II fuel management system
 - advantages, 39
 - diagram, 39
 - major components, 39

- Glow plug, 67
 - buss bar, 67
 - Removal, 77
 - removal, 77
 - sleeve, 20, 67
 - Removal, 73
 - System, 66
 - Diagnostics, 68
 - CM (Control Module), 66

- H**
- HFCM (Horizontal Fuel Conditioning Module), 29

- High boost, 79

- High EP, 79

- High pressure oil rail, 42

- High pressure oil system flow, 40-41

- High pressure pump, 42
 - cover, 42
 - removal, 76

- Horsepower & Torque, 6

- I**
- IAT1 (Intake Air Temperature 1), 59

- IAT2 (Intake Air Temperature 2), 60

- ICP (Injection Control Pressure), 42, 61
 - low, 80

- Injection nozzle, 44

- Injector
 - Buzz, 82
 - I/O test, 80
 - Installation, 71
 - O-ring replacement, 70-71
 - Removal, 69-70
 - Sleeve, 19
 - Installation, 73
 - Removal, 73

- Intake manifold, 38, 75

- Intensifier Piston, 44

- IPR (Injection Pressure Regulator), 42,64
 - Valve removal, 75

- L**
- Lubrication system
 - Features, 21
 - flow, 21-22

- M**
- MAF (Mass Air Flow), 62

- MAP (Manifold Absolute Pressure), 63

- O**
- Oil
 - aeration, 23
 - Test, 81
 - Carryover, 74
 - cooler, 24
 - housing, 24
 - Filter, 25
 - Base, 24-25
 - Replacement, 69
 - Pan, 22
 - Pressure Regulator, 23
 - pump, 23
 - Removal, 77
 - Reservoir, 25-26
 - Screen, 25

- Overview, 6

- P**
- PCM (Powertrain Control Module), 66

- Pick-up tube, 23

- Plunger, 44

- Power or ground issues, 80

INDEX

R

Rear Geartrain, 14

Relative compression test, 81

Rocker Arms, 72

Rocker carrier, 14
Removal, 72

Rocker fulcrums, 72

S

Sensors overview, 49

Single mass flywheel, 15

Specifications, 7

Stages of injection, 45

T

Table of contents, 3

Turbocharger

- Oil drain tube, 26
 - Removal, 75
- Oil supply, 26
 - Removal, 74

V

VGT (Variable Geometry Turbocharger)

- Compressor, 34
- Control valve, 35
 - Flow, 35
- Features, 34
- Turbine, 34
- Vanes closed, 36
- Vanes open, 34
- Vanes partially closed, 36

VGTCV (Variable Geometry Turbocharger Control Valve), 65

W

Water pump, 19

